

GTV



KATALOG PRODUKTÓW PRODUCT CATALOGUE КАТАЛОГ ПРОДУКЦИИ

PL **GTV** to międzynarodowy producent akcesoriów meblowych i oświetlenia. Jest jedną z najdynamiczniej rozwijających się firm w Polsce. Spółka obecna jest na kilkudziesięciu rynkach w Europie, Azji i Ameryce, a produkty z logo GTV znajdują się w milionach domów i biur na całym świecie. GTV jest firmą w 100% z polskim kapitałem. Spółka dysponuje własnym zapleczem techniczno-logistycznym umożliwiającym swobodne prowadzenie działalności o ogólnosiwiatowym zasięgu. Siedziba firmy to nowoczesne, w pełni z informatyzowane centrum logistyczne w Pruszkowie, w pobliżu autostrady A2. Na jego terenie znajduje się biurowiec oraz dwa magazyny o powierzchni 27 000 m kw. z wydzielonymi składami celnymi, mieszczące 35 000 europalet. Portfolio GTV to jedna z najbardziej kompletnych ofert na rynku. Obejmuje kilka tysięcy produktów, w kilkudziesięciu grupach produktowych, w tym m.in.: zawiasy, prowadnice, podnośniki, uchwyty, wyposażenie garderoby i kuchni oraz oświetlenie LED.

EN **GTV** is an international producer of furniture accessories and LED lighting. GTV has over 20 years of experience in cooperation with the largest furniture manufacturers in the world and millions of customers using the company's products. Today GTV is one of the international leaders in distribution of furniture accessories and LED lighting, present on dozens of markets worldwide. GTV's headquarter is a modern logistics center, located 25 km from the center of the Polish capital, Warsaw. GTV's head office is a four-story office building and two warehouses on an area of 27000 square meters with storage capacity of over 35,000 euro pallets. With its modern infrastructure, the company is able to fulfill orders from all over the world at the time indicated by the customer. GTV implementing its long-term business strategy, actively promotes it's products by participating in the world's most prestigious trade fairs e.g. in Russia, Germany, Italy, Poland, Brazil. Professional service, competent team of specialists and transparent procedures allow us to effectively meet the needs of business partners.

RU **GTV** – это международный производитель мебельной фурнитуры и освещения. Мы работаем в десятках стран Европы, Азии и Америки, а продукция с логотипом GTV известна во всем мире. GTV – это современный, полностью информатизированный логистический центр возле Варшавы. На его территории находится офисное здание и два склада площадью 27 000 м² с отдельными таможенными складами вместимостью 35 000 европаллет. Дополнительно фирма располагает складскими помещениями площадью почти 5000 квадратных метров. Ассортимент компании GTV включает несколько тысяч наименований продукции: петли, направляющие, подъемники, ручки, оснащение для гардероба и кухни, светодиодное освещение.





GTV

FURNITURE
ACCESSORIES

PL GTV Furniture Accessories, marka obecna na rynku od ponad dwudziestu lat to niekwestionowany lider dostarczający najbardziej kompletne portfolio akcesoriów dla branży meblarskiej. Dzięki przemyślanej strategii rozwoju, marka oferuje nieosiągalną dla innych firm relację ceny do jakości, dostarczając funkcjonalne oraz zaprojektowane zgodnie z najnowszymi trendami produkty w przystępnych cenach.

EN GTV Furniture Accessories brand is present on the market for over 20 years, building its position as one of the international leaders. The company is present in Europe, Asia and America, whereas products with the GTV logo are to be found in millions of households and offices worldwide. Thanks to carefully planned strategy and logistics, GTV can offer products with an unreachable for other companies price to quality ratio.

RU Мебельная фурнитура с логотипом GTV известна на рынке уже более двадцати лет, а портфолио компании является одним из наиболее полных предложений на мебельном рынке. Благодаря продуманной стратегии развития, эффективному управлению и открытости к новым идеям, компания GTV быстро стала лидером в дистрибуции мебельной фурнитуры. Секрет успеха компании заключается в предоставлении продукции высокого качества по приемлемой цене.

GTV

SLIDING DOOR SYSTEMS

- PL** GTV Sliding Door Systems, to marka która powstała w 2014 r. z myślą o profesjonalistach poszukujących rozwiązań ułatwiających i przyspieszających montaż drzwi przesuwnych. Systemy przesuwne zostały zaprojektowane przez naszych konstruktorów, dla których inspiracją były opinie polskich stolarzy. Dzięki tej owocnej współpracy powstał produkt, który nie tylko przekonuje praktycznymi, konstrukcyjnymi ulepszeniami. Są to również szczegóły decydujące o przewadze produktu jak unikatowy materiał, z którego wykonane zostały kółka w systemach jezdnych.
- EN** GTV Sliding Door Systems is a brand developed in 2014, for professionals seeking reliability and highest quality. Our systems have been created to meet the needs, of the most demanding customers. The idea behind the systems was inspired by carpenters, who tend to look for solutions, that will make their work more effective. GTV Sliding Door Systems offer not only practical constructional improvements. But also highest quality of components. The whole system is based on reliable elements, especially rollers thanks to which this system stands out of the competition. All of the functional accessories have been carefully selected and underwent thorough strict quality control.
- RU** Раздвижные системы GTV - бренд, созданный в 2014 году с мыслью о профессионалах, ищущих новые возможности, позволяющие ускорить процесс установки раздвижных дверей. Раздвижные системы GTV были запроектированы по инициативе производителей мебели и являются авторской разработкой инженеров компании GTV. В результате плодотворной работы был создан продукт, интересный не только своими техническими решениями, но и отличающийся качеством используемого материала в нижних ходовых элементах.

GTV

LIGHTING

- PL** Marka GTV Lighting została wprowadzona na rynek 2007 r. oferując rozwiązania oświetleniowe przeznaczone do biur, budynków przemysłowych, magazynowych i użyteczności publicznej opartych na technologii LED. Portfolio zawiera również produkty LED dla klientów indywidualnych – źródła LED, oświetlenie meblowe. GTV Lighting to szeroka i kompletna oferta, elastyczność w podejściu do partnerów biznesowych a także serwis.
- EN** The GTV Lighting brand was launched in 2007, it has been created, to provide professional lighting solutions for offices, industrial buildings and warehouses - based on LED technology. The portfolio also includes LED solutions for private consumers - home and garden lighting, furniture lighting. GTV Lighting offers also a wide and complete portfolio of services, such as lighting planning consulting.
- RU** Товарная группа GTV освещение появилась в ассортименте компании в 2007 году и представляет собой подборку интересных световых решений для офисов, промышленных зданий, складских помещений, общественных зданий, а также решений подходящих индивидуальным клиентам - источники светодиодного освещения и освещение для мебели. GTV освещение предлагает широкий спектр продукции и гибкость в подходе к бизнес-партнёрам и услугам, которые мы предоставляем.

AKCESORIA FUNKCYJNE FUNCTIONAL ACCESSORIES ФУНКЦИОНАЛЬНАЯ ФУРНИТУРА

Zawiasy Hinges Петли	8 – 39
Amortyzatory Buffers Амортизаторы	40 – 45
Podnośniki Lifts Подъёмники	46 – 55
Prowadnice Slides Направляющие	56 – 87
Systemy szuflad Drawer systems Выдвижные ящики	88 – 125
Elementy łączeniowe Brackets and fittings Соединительные элементы	126 – 156
Listwy Work top strip Планки для столешниц	157 – 161
Mocowania do rur Rails accessories and fittings Крепление для труб	162 – 182
Wyposażenie garderoby Wardrobe accessories Наполнение для шкафов-купе	183 – 203
Akcesoria kuchenne Kitchen accessories Кухонные аксессуары	204 – 232
Akcesoria biurowe Office accessories Аксессуары для офиса	233 – 238
Inne Other Другие	239 – 241

AKCESORIA DEKORACYJNE DECORATIVE ACCESSORIES ЛИЦЕВАЯ ФУРНИТУРА

Uchwyty Handles Ручки	244 – 329
Wieszaki Hooks Крючки	330 – 342

Nóżki meblowe Furniture legs Мебельные ножки	343 – 372
Nogi meblowe Furniture legs Мебельные опоры	373 – 378
Rolki meblowe Furniture castors Мебельные колёсики	379 – 383
Zamki meblowe Cabinet locks Замки	384 – 391

SYSTEMY PRZESUWNE SLIDING DOOR SYSTEMS РАЗДВИЖНЫЕ СИСТЕМЫ

Dolny układ jezdny Bottom-running systems Нижняя ходовая система	394 – 420
Górny układ jezdny Top-running systems Верхняя ходовая система	421 – 425

OŚWIETLENIE MEBLOWE FURNITURE LIGHTING МЕБЕЛЬНОЕ ОСВЕЩЕНИЕ

Taśmy LED LED strips Светодиодные ленты	428 – 429
Profile LED LED profiles Профили LED	430 – 448
Oprawy LED LED fittings Светодиодные светильники	449 – 469
Oprawy halogenowe Halogen fitting Галогенные светильники	470 – 471
Akcesoria Accessories Аксессуары	472 – 490
Przedłużacze biurkowe Desk power sockets Выдвижные розетки	491 – 497

**AKCESORIA FUNKCYJNE
FUNCTIONAL ACCESSORIES
ФУНКЦИОНАЛЬНАЯ ФУРНИТУРА**

Zawiasy Hinges Петли	8 – 39
Amortyzatory Buffers Амортизаторы	40 – 45
Podnośniki Lifts Подъёмники	46 – 55
Prowadnice Slides Направляющие	56 – 87
Systemy szuflad Drawer systems Выдвижные ящики	88 – 125
Elementy łączeniowe Brackets and fittings Соединительные элементы	126 – 156
Listwy Work top strip Планки для столешниц	157 – 161
Mocowania do rur Rails accessories and fittings Крепление для труб	162 – 182
Wyposażenie garderoby Wardrobe accessories Наполнение для шкафов-купе	183 – 203
Akcesoria kuchenne Kitchen accessories Кухонные аксессуары	204 – 232
Akcesoria biurowe Office accessories Аксессуары для офиса	233 – 238
Inne Other Другие	239 – 241





MB
MODERN BOX

Orientacyjna ilość zawiasów puszkowych Ø35*

* nie dotyczy modeli specjalnych o szerokim kącie otwarcia

Approximate amount of hinges Ø35*

* not applicable for special hinges with wide opening angle

Приблизительное количество шарнирных петель Ø35*

* не касается специальных моделей с широким углом открывания

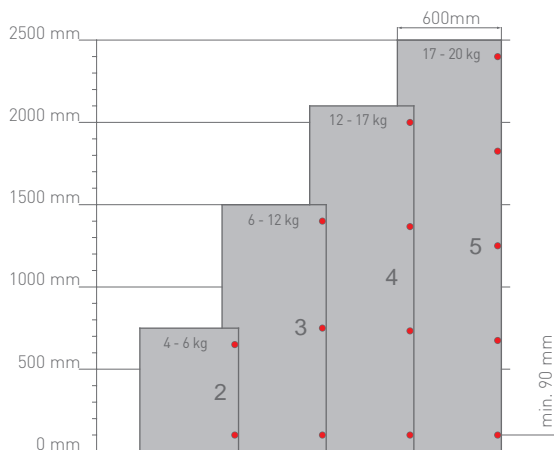

Orientacyjna ilość zawiasów puszkowych Ø26 oraz Ø35*

* dotyczy modeli specjalnych o szerokim kącie otwarcia

Approximate amount of hinges Ø26 and Ø35

* not applicable for special hinges with wide opening angle

Приблизительное количество шарнирных петель Ø26 и Ø35*

* касается специальных моделей с широким углом открывания

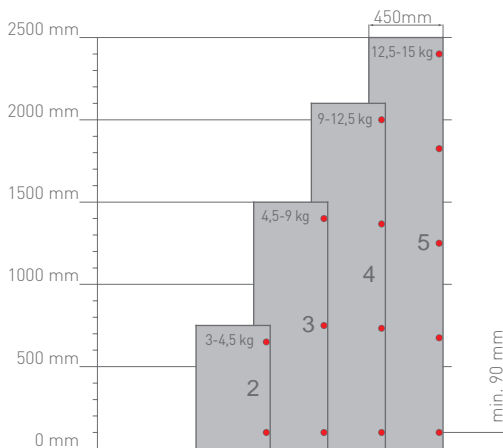

- Ilość użytych zawiasów jest zależna od wysokości, szerokości i ciężaru frontu.
- W celu zapewnienia stabilności, odległość między zawiasami powinna być jak największa.
- Przed przystąpieniem do seryjnej produkcji należy przeprowadzić próbę montażu i sprawdzić poprawność funkcjonowania.
- To ensure stability, the distance between the hinges should be as big as possible.
- Number of hinges that should be used, depends on the height, width and weight of the front.
- Before starting mass production, mounting tests should be performed in order to ensure proper functioning.
- Количество использованных петель зависит от высоты, ширины и веса фасада.
- Для обеспечения стабильности, расстояние между петлями должно быть как можно больше.
- Перед началом серийного производства необходимо провести пробу монтажа и проверить исправность функциональности петель.

Zawias hydrauliczny ECHC, nakładany
 Hydraulic cup hinge ECHC, overlay door
 Гидравлическая петля ECHC, накладная

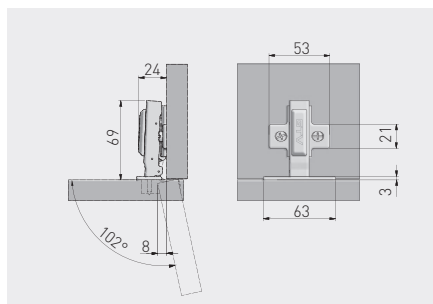

ZM-ECHC09BEO	H=0	x 4	—	nikiel nickel никель	stal steel сталь	
ZM-ECHC09ZEO		x 2	x 2			



Zawias hydrauliczny ECHC, bliźniaczy
 Hydraulic cup hinge ECHC, twin overlay door
 Гидравлическая петля ECHC, полунакладная

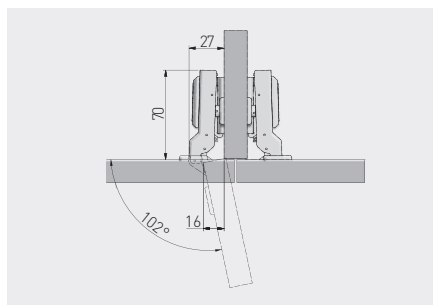

ZM-ECHC08BEO	H=0	x 4	—	nikiel nickel никель	stal steel сталь	
ZM-ECHC08ZEO		x 2	x 2			



Zawias hydrauliczny ECHC, wpuszczany
 Hydraulic cup hinge ECHC, inset door
 Гидравлическая петля ECHC, внутренняя

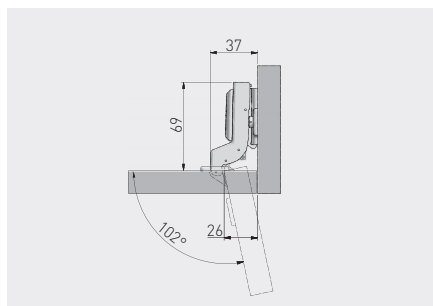

ZM-ECHC07BEO	H=0	x 4	—	nikiel nickel	stal steel
ZM-ECHC07ZEO		x 2	x 2	никель nickel	сталь steel



Zawias hydrauliczny HCRE z regulacją prędkości zamknięcia, nakładany
 Hydraulic cup hinge HCRE with closing time adjustment, overlay door
 Гидравлическая петля HCRE с регулировкой скорости закрытия, накладная

NEW

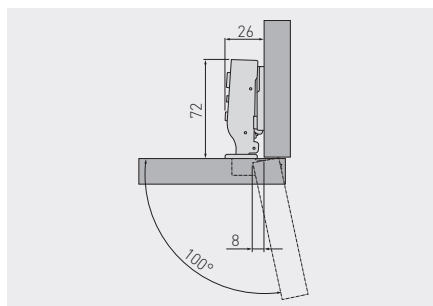

ZM-HCREG09-ZEO	H=0	x 4	—	nikiel nickel никель	stal steel сталь



Zawias hydrauliczny HCRE z regulacją prędkości zamknięcia, bliźniaczy
 Hydraulic cup hinge HCRE with closing time adjustment, twin overlay door
 Гидравлическая петля HCRE с регулировкой скорости закрытия, полунакладная

NEW

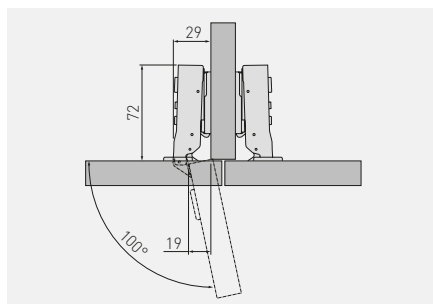







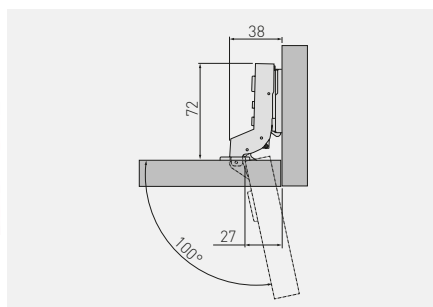









					
ZM-HCREG08-ZEO	H=0	x 4	—	nikiel nickel нικель	stal steel стал
					
					

Zawias hydrauliczny HCRE z regulacją prędkości zamknięcia, wpuszczany
 Hydraulic cup hinge HCRE with closing time adjustment, inset door
 Гидравлическая петля HCRE с регулировкой скорости закрытия, внутренняя

NEW



					
ZM-HCREG07-ZEO	H=0	x 4	—	nikiel nickel нικель	stal steel стал
					
					

Zawias hydrauliczny ECHC z regulacją mimośrodową, nakładany
 Hydraulic cup hinge ECHC with eccentric adjustment, overlay door
 Гидравлическая петля ECHC с эксцентриком, накладная

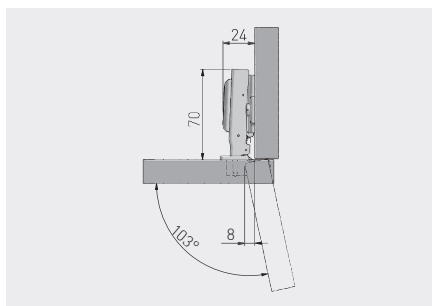

ZM-ECHC09-3DBEO	H=0	x 4	—	nikiel nickel никель	stal steel сталь						

Zawias hydrauliczny ECHC z regulacją mimośrodową, bliźniaczy
 Hydraulic cup hinge ECHC with eccentric adjustment, twin overlay door
 Гидравлическая петля ECHC с эксцентриком, полунакладная

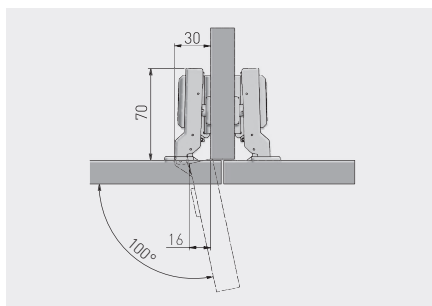

ZM-ECHC08-3DBEO	H=0	x 4	—	nikiel nickel никель	stal steel сталь						

Zawias hydrauliczny ECHC z regulacją mimośrodową, wpuszczany
 Hydraulic cup hinge ECHC with eccentric adjustment, inset door
 Гидравлическая петля ECHC с эксцентриком, внутренняя

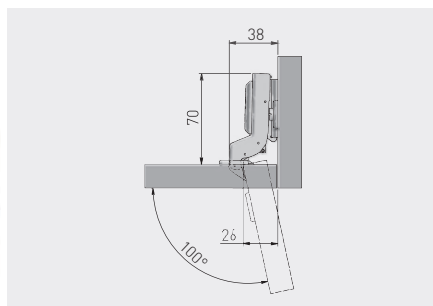

ZM-ECHC07-3DBE0	H=0	x 4	—	nikiel nickel никель	stal steel сталь



Zawias hydrauliczny CNHC z regulacją mimośrodową, nakładany
 Hydraulic cup hinge CNHC with eccentric adjustment, overlay door
 Гидравлическая петля CNHC с эксцентриком, накладная

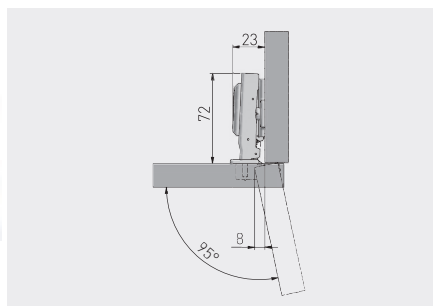

ZM-CNHC09BR2	H=0	x2	x 2	nikiel nickel никель	stal steel сталь



Zawias hydrauliczny CNHC z regulacją mimośrodową, bliźniaczy
 Hydraulic cup hinge CNHC with eccentric adjustment, twin overlay door
 Гидравлическая петля CNHC с эксцентриком, полунакладная

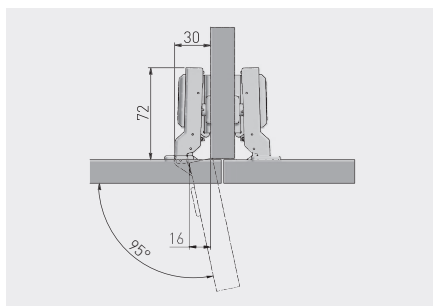

ZM-CNHC08BR2	H=0	x 2	x 2	nikiel nickel нικель	stal steel сталь						

Zawias hydrauliczny CNHC z regulacją mimośrodową, wpuszczany
 Hydraulic cup hinge CNHC with eccentric adjustment, inset door
 Гидравлическая петля CNHC с эксцентриком, внутренняя

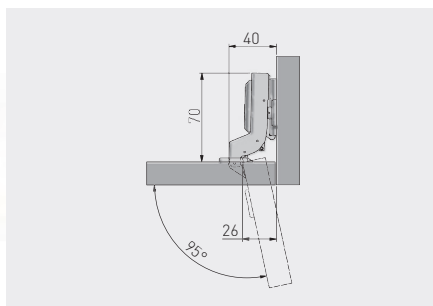

ZM-CNHC07BR2	H=0	x 2	x 2	nikiel nickel нικель	stal steel сталь						

Zawias hydrauliczny INHC, nakładany
 Hydraulic cup hinge INHC, overlay door
 Гидравлическая петля INHC, накладная

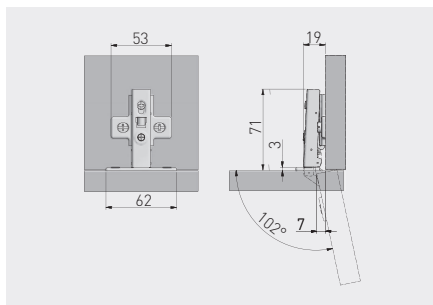

ZM-INHC090BEO	H=0	—	—	2	nikiel nickel никель	stal steel сталь
ZM-INHC090ZEO		—	—			



Zawias hydrauliczny INHC, bliźniaczy
 Hydraulic cup hinge INHC, twin overlay door
 Гидравлическая петля INHC, полунакладная

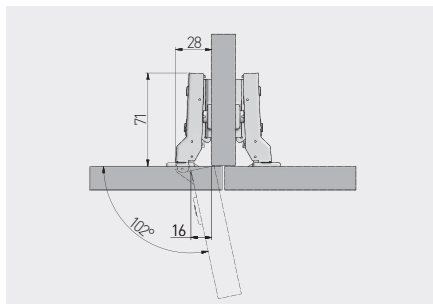

ZM-INHC080BEO	H=0	—	—	2	nikiel nickel никель	stal steel сталь
ZM-INHC080ZEO		—	—			



Zawias hydrauliczny INHC, wpuszczany
 Hydraulic cup hinge INHC, inset door
 Гидравлическая петля INHC, внутренняя

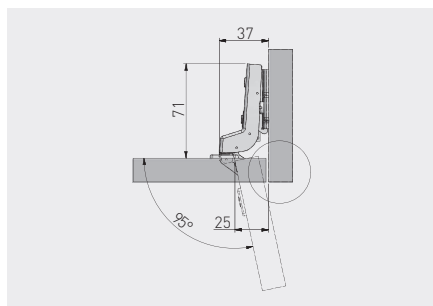

ZM-INHC070BEO	H=0	—	—	nikiel	stal
ZM-INHC070ZEO		—	x 2	nickel	steel
				ннкель	сталь



Zawias kątowy 30°, hydrauliczny HCKT
 Hydraulic corner cup hinge 30° HCKT
 Угловая петля 30°, гидравлическая HCKT

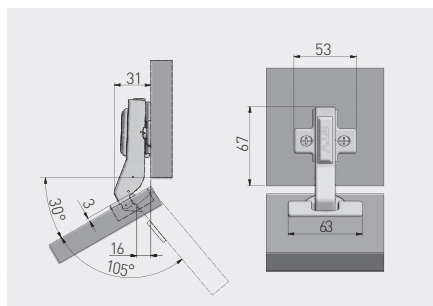

ZM-HCKT30-BE	H=0	x 4	—	nikiel	stal, ZnAl
ZM-HCKT30-ZE		x 2	x 2	nickel	steel, ZnAl
				ннкель	сталь, ZnAl



Zawias kątowy 45° hydrauliczny HCKT
 Hydraulic corner cup hinge 45° HCKT
 Угловая петля 45°, гидравлическая HCKT

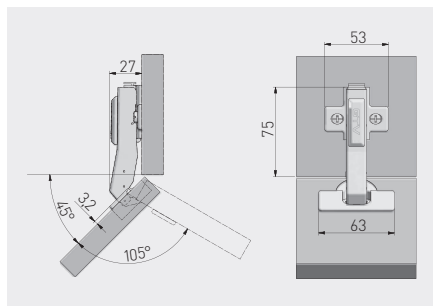

ZM-HCKT45-BE	H=0	x 4	—	nikiel nickel никель	stal, ZnAl steel, ZnAl сталь, ZnAl
ZM-HCKT45-ZE		x 2	x 2		



Zawias kątowy 45° HCKT z regulacją mimośrodową
 Corner hinge 45° HCKT with eccentric adjustment
 Угловая петля 45° HCKT с эксцентриком

NEW

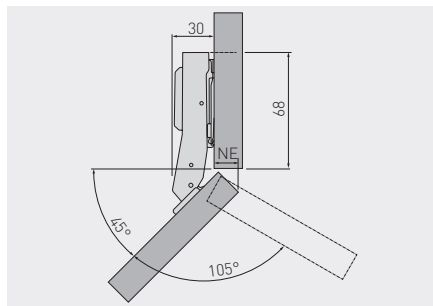

ZM-HCKT45-3DBEO	H=0	—	—	nikiel nickel никель	stal, ZnAl steel, ZnAl сталь, ZnAl
-----------------	-----	---	---	----------------------------	--



Zawias równoległy hydrauliczny HCKT
 Parallel hydraulic hinge HCKT
 Гидравлическая петля под фальшпанель HCKT

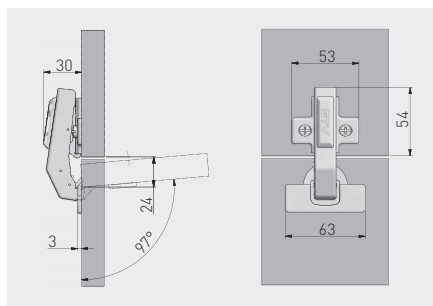

ZM-HCKT90-BE	H=0	x 4	—	nikiel nickel	stal, ZnAl steel, ZnAl					
ZM-HCKT90-ZE		x 2	x 2	никель	сталь, ZnAl					

Zawias równoległy HCKT z regulacją mimośrodową
 Parallel hinge HCKT with eccentric adjustment
 Петля под фальшпанель HCKT с эксцентриком

NEW

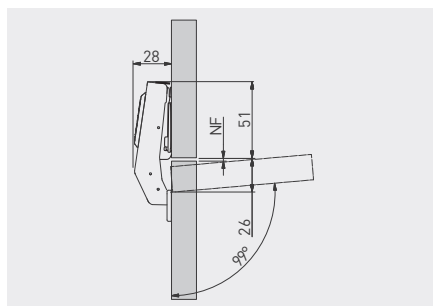
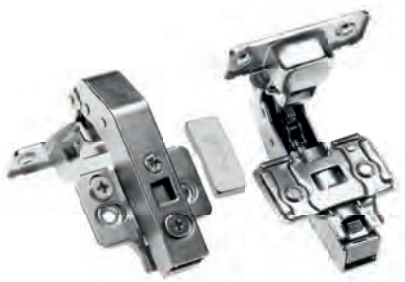

ZM-HCKT90-3DBE0	H=0	—	—	nikiel nickel никель	stal / ZnAl steel / ZnAl сталь / ZnAl					

Zawias z ujemnym uskokiem 155° hydrauliczny HCKT
 Hydraulic set-off hinge 155° HCKT
 Гидравлическая петля 155° HCKT

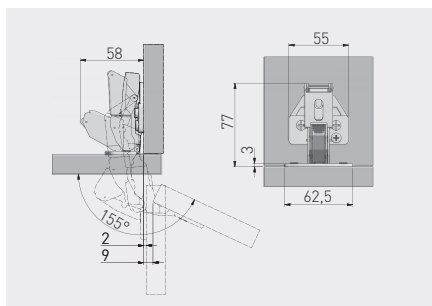

ZM-HCKT155BE	H=0	—	—	nikiel nickel никель	stal steel сталь
ZM-HCKT155ZE		—	x 2		



Zawias 165° hydrauliczny HCKT
 Hydraulic hinge 165° HCKT
 Гидравлическая петля 165° HCKT

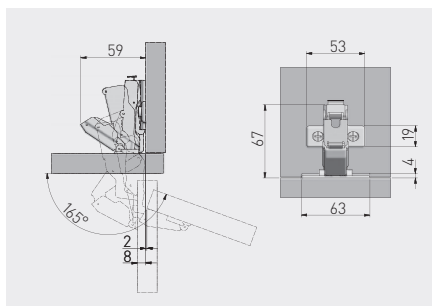

ZM-HCKT165BE	H=0	—	—	nikiel nickel никель	stal, ZnAl steel, ZnAl сталь, ZnAl
ZM-HCKT165ZE		—	x 2		



Zawias 165° hydrauliczny HCKT z regulacją mimośrodową
 Hydraulic hinge 165° HCKT with eccentric adjustment
 Гидравлическая петля 165° HCKT с эксцентриком

NEW

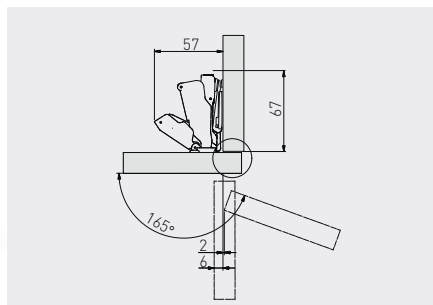

ZM-HCKT165-3DBEO	H=0	—	—	nikiel nickel никель	stal, ZnAl steel, ZnAl сталь, ZnAl



Zawias CONL, nakładany
 Hinge CONL, overlay door
 Петля CONL, накладная

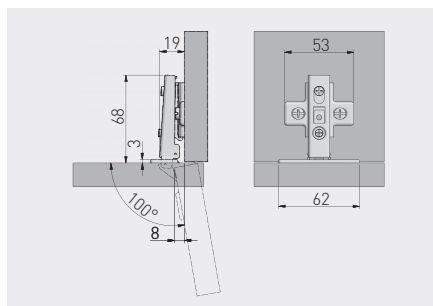

ZP-CONL09-BE	H=0	—	—	nikiel nickel никель	stal steel сталь
ZP-CONL09-ZE		—	x 2		



Zawias CONL, bliźniaczy
Hinge CONL, twin overlay door
Петля CONL, полунакладная

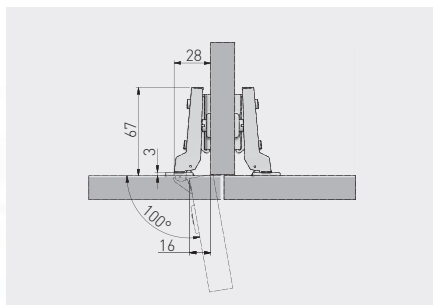

ZP-CONL08-BE	H=0	—	—	nikiel nickel никель	stal steel сталь
ZP-CONL08-ZE		—	x 2		



Zawias CONL, wpuszczany
Hinge CONL, inset door
Петля CONL, внутренняя

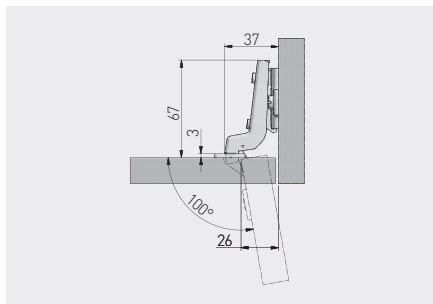

ZP-CONL07-BE	H=0	—	—	nikiel nickel никель	stal steel сталь
ZP-CONL07-ZE		—	x 2		



Zawias BICN, nakładany
Hinge BICN, overlay door
Петля BICN, накладная

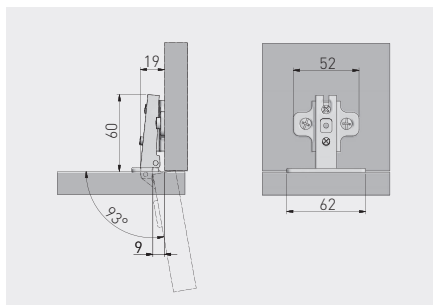

ZP-BICN090BEO	H=0	—	—	nikiel nickel никель	stal steel сталь
ZP-BICN090ZEO		—	x 2		
ZP-BICN092BEO	H=2	—	—	nikiel nickel никель	stal steel сталь
ZP-BICN092ZEO		—	x 2		



Zawias BICN, bliźniaczy
Hinge BICN, twin overlay door
Петля BICN, полунакладная

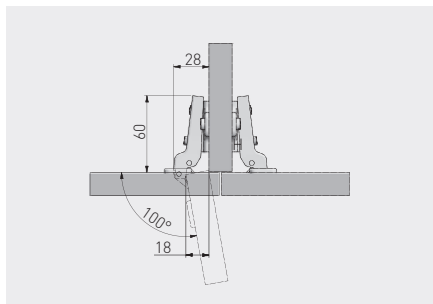

ZP-BICN080BEO	H=0	—	—	nikiel nickel никель	stal steel сталь
ZP-BICN080ZEO		—	x 2		
ZP-BICN082BEO	H=2	—	—	nikiel nickel никель	stal steel сталь
ZP-BICN082ZEO		—	x 2		



Zawias BICN, wpuszczany
Hinge BICN, inset door
Петля BICN, внутренняя

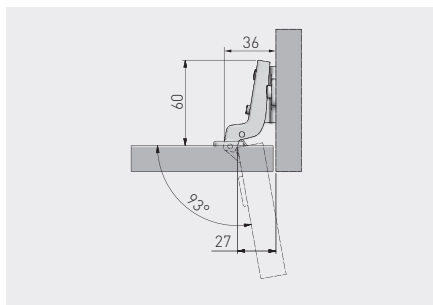

ZP-BICN070BEO	H=0	—	—	nikiel nickel никель	stal steel сталь		
ZP-BICN070ZEO		—	x 2				
ZP-BICN072BEO	H=2	—	—				
ZP-BICN072ZEO		—	x 2				



Zawias kątowy 30° KT
Corner hinge 30° KT
Угловая петля 30° KT

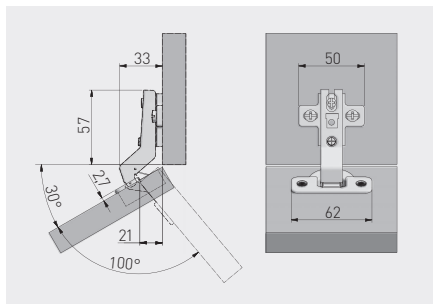

ZP-KT30H2-BE	H=2	—	—	nikiel nickel никель	stal steel сталь		
ZP-KT30H2-ZE		—	x 2				



Zawias kątowy 45° KT
 Corner hinge 45° KT
 Угловая петля 45° KT

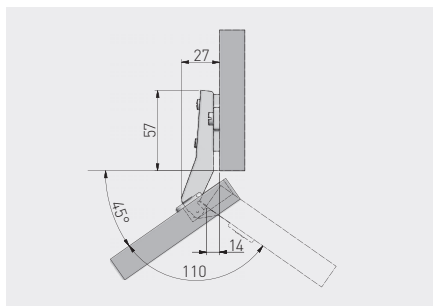

ZP-KT45H2-BE	H=2	—	—	nikiel nickel никель	stal steel сталь
ZP-KT45H2-ZE		—	x 2		



Zawias równoległy KT
 Parallel hinge KT
 Петля под фальшпанель KT

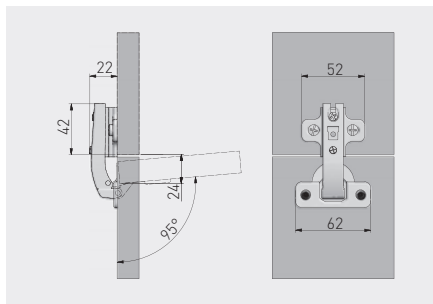

ZP-KT90H2-BE	H=2	—	—	nikiel nickel никель	stal steel сталь
ZP-KT90H2-ZE		—	x 2		



Zawias równoległy – krótkie ramię KTK
 Parallel hinge – short arm KTK
 Петля под фальшпанель с коротким плечем КTK

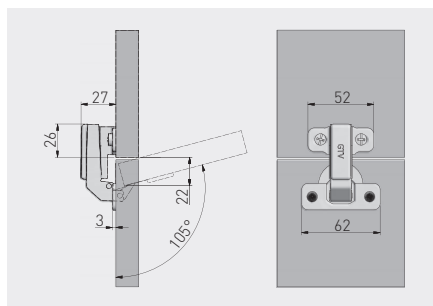

ZP-KTK90H6BE	H=6	—	—	nikiel nickel никель	stal steel сталь
ZP-KTK90H6ZE		—	x 2		



Zawias równoległy nakładany – krótkie ramię KTKN
 Parallel hinge for overlay door – short arm KTKN
 Петля под фальшпанель с коротким плечем, накладная КTKN

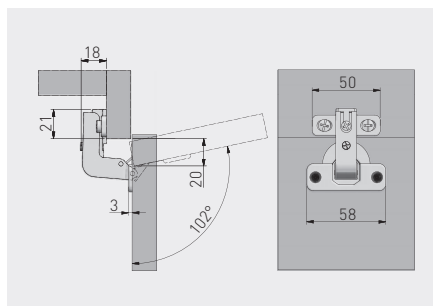

ZP-KTKN90H0	H=0	—	x 2	nikiel nickel никель	stal, ZnAl steel, ZnAl сталь, ZnAl



Zawias 165° KT
Hinge 165° KT
Петля 165° KT

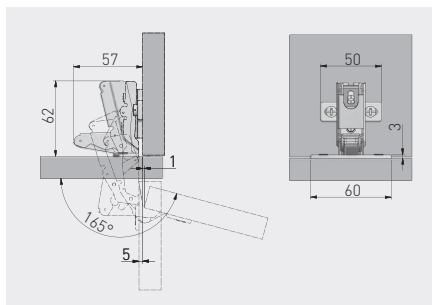

ZP-KT165H2BE	H=2	—	—	nikiel nickel никель	stal steel сталь
ZP-KT165H2ZE		—	x 2		



Zawias 135° KT
Complementary hinge 135° KT
Петля для складных дверей 135° KT

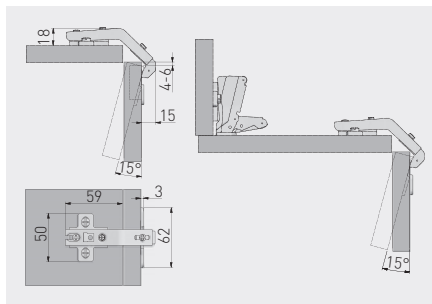

ZP-KT135H2-BE	H=2	—	—	nikiel nickel никель	stal, ZnAl steel, ZnAl сталь, ZnAl
ZP-KT135H2-ZE		—	x 2		



Zawias bez sprężyny COCA, nakładany
 Hinge without spring COCA, overlay door
 Петля без пружины СОСА, накладная

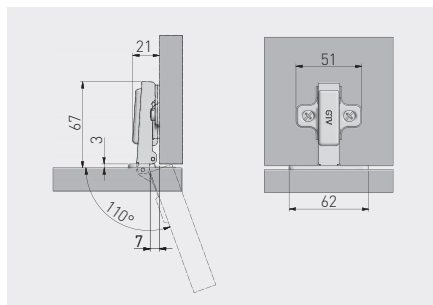

ZP-COCA450-BE	H=0	—	—	nikiel nickel никель	stal steel сталь
ZP-COCA450-ZE		—	x 2		



Zawias bez sprężyny COCA, wpuszczany
 Hinge without spring COCA, inset door
 Петля без пружины СОСА, внутренняя

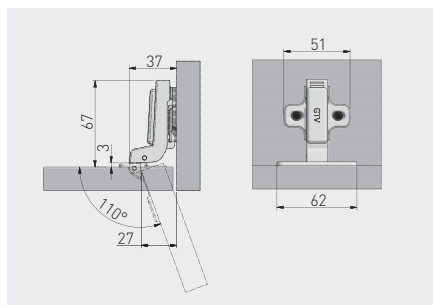

ZP-COCA7450-BE	H=0	—	—	nikiel nickel никель	stal steel сталь



Zawias samootwierający P0, nakładany
 Self-opening hinge P0, overlay door
 Петля самооткрывающаяся P0, накладная

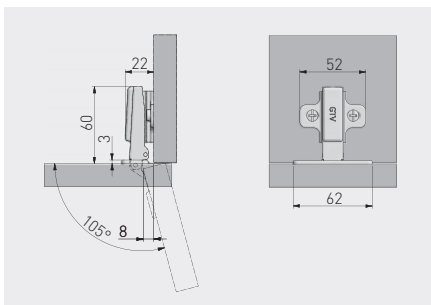

ZP-P0H045BEO	H=0	—	—	nikiel nickel	stal steel
ZP-P0H045ZEO		—	x 2	никель	сталь

Zawias samootwierający P0, wpuszczany
 Self-opening hinge P0, inset door
 Петля самооткрывающаяся P0, внутренняя

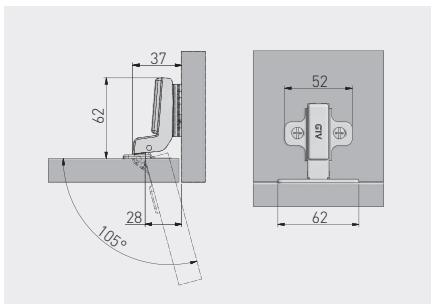

ZP-P07H045BE	H=0	—	—	nikiel nickel	stal steel

Zawias hydrauliczny mini CIHC, nakładany
 Hydraulic hinge mini CIHC, overlay door
 Гидравлическая петля мини CIHC, накладная

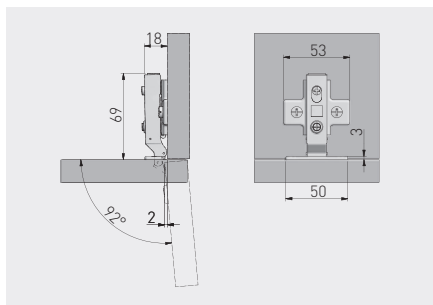

ZP-CIHC090ZE	H=0	x 2	x 2	nikiel nickel никель	stal, ZnAl / steel, ZnAl / сталь, ZnAl					
ZM-CIHC09ZE					stal / steel / сталь					

Zawias hydrauliczny mini CIHC, bliźniaczy
 Hydraulic hinge mini CIHC, twin overlay door
 Гидравлическая петля мини CIHC, полунакладная

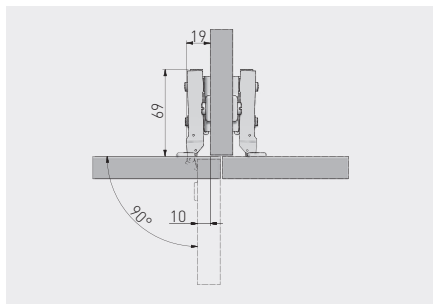

ZP-CIHC080ZE	H=0	x 2	x 2	nikiel nickel никель	stal, ZnAl / steel, ZnAl / сталь, ZnAl					
ZM-CIHC08ZE					stal / steel / сталь					

Zawias hydrauliczny mini CIHC, wpuszczany
 Hydraulic hinge mini CIHC, inset door
 Гидравлическая петля мини CIHC, внутренняя

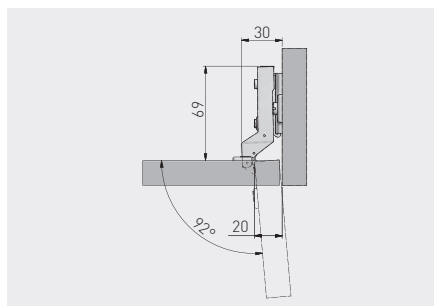

ZP-CIHC070ZE	H=0	x 2	x 2	nikiel nickel никель	stal, ZnAl / steel, ZnAl / сталь, ZnAl					
ZM-CIHC07ZE					stal / steel / сталь					

Zawias mini CIBI, nakładany
 Hinge mini CIBI, overlay door
 Петля мини CIBI, накладная

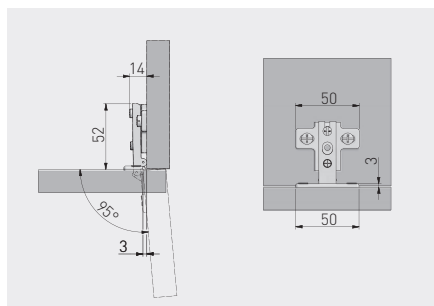

ZP-CIBI9H0ZE	H=0	-	x 2	nikiel nickel никель	stal steel сталь					

Zawias mini CIBI, bliźniaczy
Hinge mini CIBI, twin overlay door
Петля мини CIBI, полунакладная

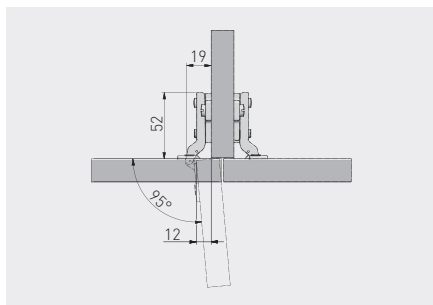

ZP-CIBI8HOZE	H=0	-	x 2	nikiel nickel никель	stal steel сталь



Zawias mini CIBI, wpuszczany
Hinge mini CIBI, inset door
Петля мини CIBI, внутренняя

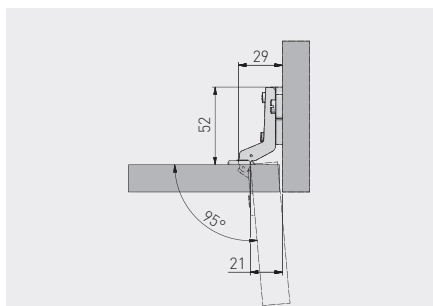

ZP-CIBI7HOZE	H=0	-	x 2	nikiel nickel никель	stal steel сталь



Zawias równoległy mini CI90
 Parallel hinge mini CI90
 Петля мини под фальшпанель CI90

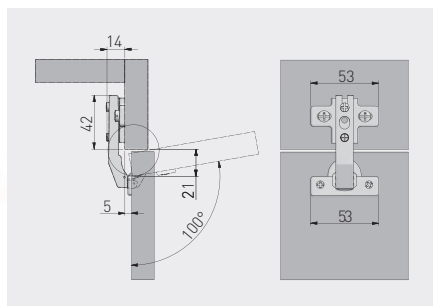

ZP-CI90H2-ZE	H=2	x 2	x 2	nikiel nickel никель	stal steel сталь



Zawias do szkła CIG, nakładany
 Hinge for glass CIG, overlay door
 Петля для стеклянных дверей CIG, накладная

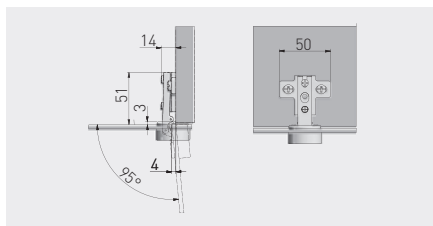

ZP-CIG-090ZE	H=0	—	x 2	nikiel nickel никель	stal, tworzywo steel, plastic сталь, пластмасса	○	chrom / chrome / хром
ZP-CIG-09UZE		—	x 2			◻	
ZP-CIG-09UBE		—	—			◻	
ZP-CIG-09UZC		—	x 2			◻	czarny / black / чёрный
ZP-CIG-190ZE		—	x 2			○	aluminium aluminium алюминий
ZP-CIG-19UZE		—	x 2			◻	



Zawias do szkła CIG, wpuszczany
 Hinge for glass CIG, inset door
 Петля для стеклянных дверей CIG, внутренняя

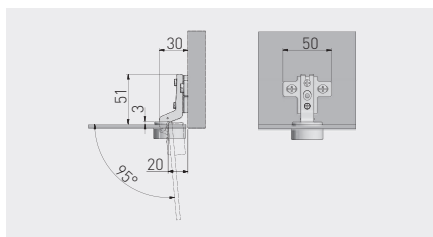

ZP-CIG-070ZE	H=0	—	x 2	nikiel nickel никель	stal, tworzywo steel, plastic сталь, пластмасса	○	chrom chrome хром
ZP-CIG-07UZE		—	x 2			◻	
ZP-CIG-170ZE		—	x 2			○	aluminium aluminium алюминий
ZP-CIG-17UZE		—	x 2			◻	



Zawias do ramek aluminiowych, nakładany
 Hinge for aluminium frames, overlay door
 Петля GTV для алюминиевых рамок, с клипом, накладная

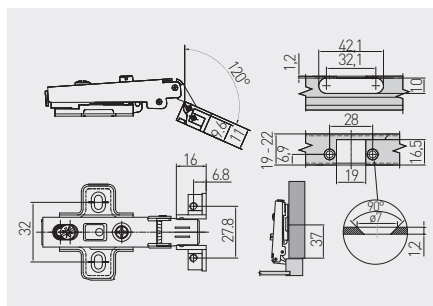

Produkt kompatybilny: profil aluminiowy do frontów: PA-3731-35-50
 Product compatible with aluminum profile for fronts: PA-3731-35-50
 Подходит для алюминиевых профилей под индексом: PA-3731-35-50

ZP-RALUH2-00	H=2	—	—	nikiel nickel plated никель	stal steel сталь

Zawias do ramek aluminiowych, bliźniaczy
 Hinge for aluminium frames, twin overlay door
 Петля GTV для алюминиевых рамок, с клипом, полунакладная

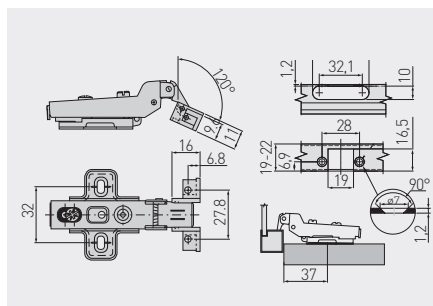

Produkt kompatybilny: profil aluminiowy do frontów: PA-3731-35-50
 Product compatible with aluminum profile for fronts: PA-3731-35-50
 Подходит для алюминиевых профилей под индексом: PA-3731-35-50

ZP-RALUH2-08	H=2	—	—	nikiel nickel plated никель	stal steel сталь

Zawias do ramek aluminiowych, wpuszczany
 Hinge for aluminium frames, inset door
 Петля GTV для алюминиевых рамок, с клипом, внутренняя

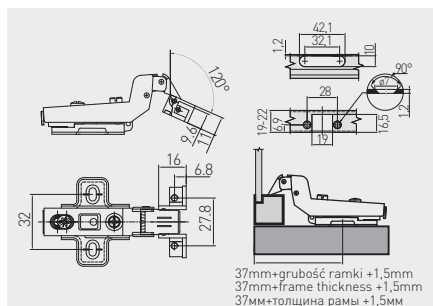

Produkt kompatybilny: profil aluminiowy do frontów: PA-3731-35-50
 Product compatible with aluminum profile for fronts: PA-3731-35-50
 Подходит для алюминиевых профилей под индексом: PA-3731-35-50

ZP-RALUH2-07	H=2	—	—	nikiel nickel plated никель	stal steel сталь

Zawias hydrauliczny do ramek aluminiowych, nakładany
 Hinge for aluminium frame, overlay door
 Петля GTV для алюминиевых рамок, с клипом, накладная

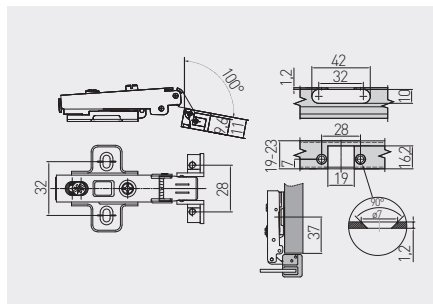

Produkt kompatybilny: profil aluminiowy do frontów: PA-3731-35-50
 Product compatible with aluminum profile for fronts: PA-3731-35-50
 Подходит для алюминиевых профилей под индексом: PA-3731-35-50

ZM-HCRALU9BE	H=0	—	—	nikiel nickel plated никель	stal steel сталь

Zawias 270°, nakładany
Hinge 270°, overlay door
Петля 270°, накладная

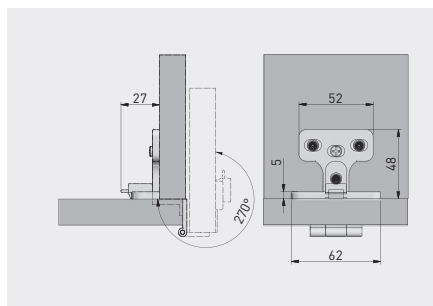

ZP-KT0270-BE	—	—	nikiel nickel никель	ZnAl
			CLIP-ON	x 100

Zawias 270°, wpuszczany
Hinge 270°, inset door
Петля 270°, внутренняя

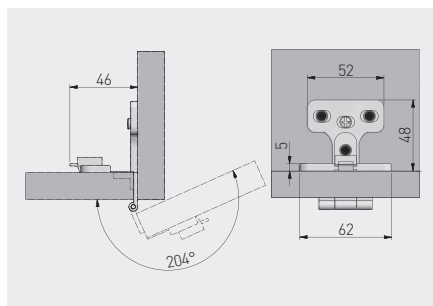

ZP-KT7270-BE	—	—	nikiel nickel никель	ZnAl
			CLIP-ON	x 100

Zawias tłoczkowy duży
 Cylinder hinge large
 Поршневая петля (большая)

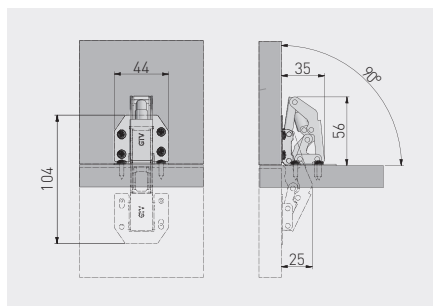

ZT-HF-01-D00	—	—	nikiel nickel никель	stal steel сталь



Zawias tłoczkowy mały
 Cylinder hinge small
 Поршневая петля (малая)

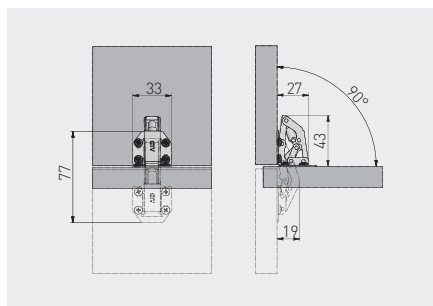

ZT-HF-01-M00	—	—	nikiel nickel никель	stal steel сталь



Zawias JUNIOR 75°
 JUNIOR hinge 75°
 Петля JUNIOR 75°

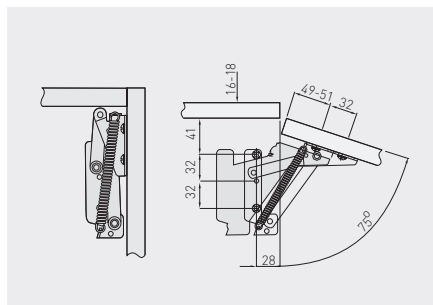

ZP-JUNIOR-00	—	—	nikiel nickel никель	stal steel сталь



Zawias skrzydełkowy
 Butterfly hinge
 Петля-бабочка

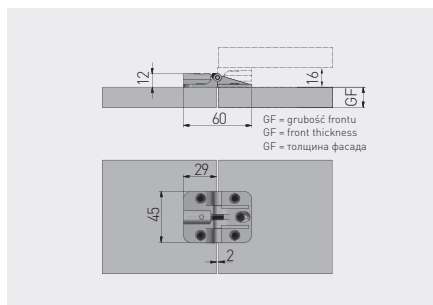

ZP-SKR-00-80	—	—	lakier lacquer лак	szary gray серый	ZnAl



Zawias cylindryczny
Cylinder hinge
Петля цилиндрическая

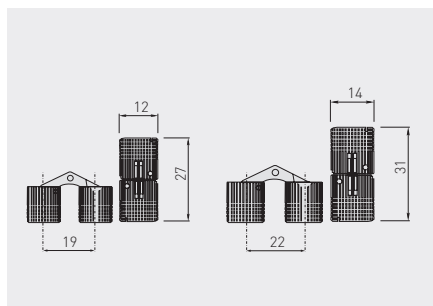

ZC-GTV-12-00	12	7	mosiądz brass латунь	mosiądz brass латунь
ZC-GTV-14-00	14			



Zawias barkowy
Flap hinge
Барная петля

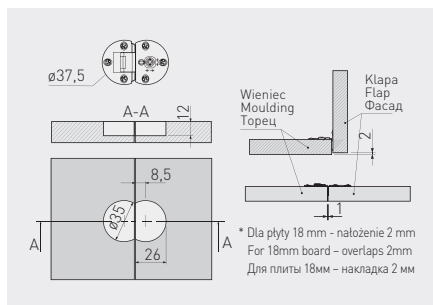

PD-MD-ZB-01	chrom / chrome / хром	ZnAl
PD-MD-ZB-04	antyczny mosiądz / antique brass / античная латунь	



Amortyzator regulowany z adapterem prostym
Adjustable buffer with straight adapter
Амортизатор регулируемый с прямым адаптером

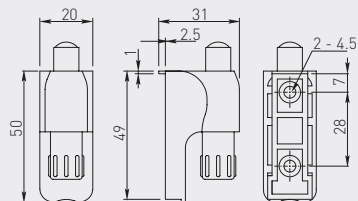

AM-BOCZ01-60	szary gray серый	tworzywo plastic пластмасса
--------------	------------------------	-----------------------------------



Amortyzator z adapterem prostym
Buffer with straight adapter
Амортизатор с прямым адаптером

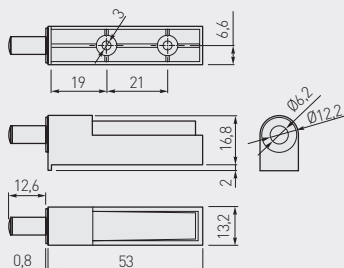

AM-PROST-KPL	szary gray серый	tworzywo plastic пластмасса
--------------	------------------------	-----------------------------------



Amortyzator z adapterem krzyżakowym
Buffer with cross adapter
Амортизатор с крестовым адаптером

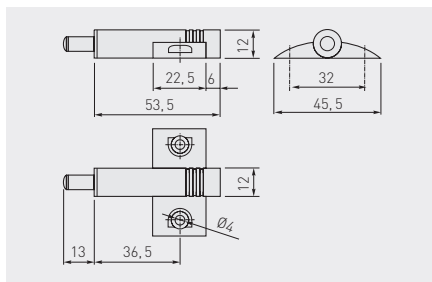

AM-KRZYZ-KPL	szary gray серый	tworzywo plastic пластмасса
--------------	------------------------	-----------------------------------



Amortyzator AM-ODB
Buffer AM-ODB
Амортизатор AM-ODB

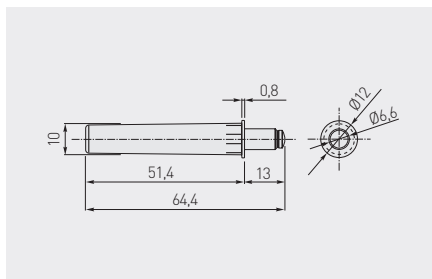

AM-ODB01S-60	strong	szary / gray / серый	tworzywo / plastic / пластмасса
AM-ODB000-60	standard		
AM-ODB000-10		biały / white / белый	



Adapter AM-ODB prosty
 Adapter AM-ODB straight
 Адаптер AM-ODB прямой

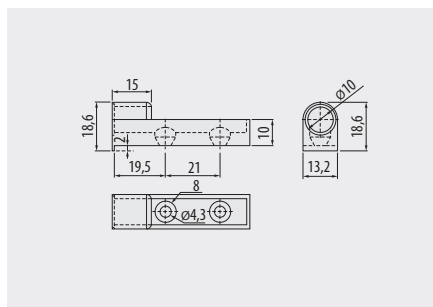
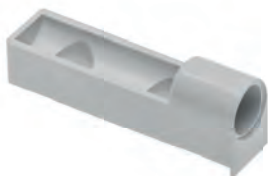

		
AM-ADAP0B-60	szary / gray / серый	tworzywo / plastic / пластмасса
AM-ADAP0B-10	biały / white / белый	



Adapter AM-ODB krzyżakowy
 Cross adapter AM-ODB
 Адаптер AM-ODB крестовой

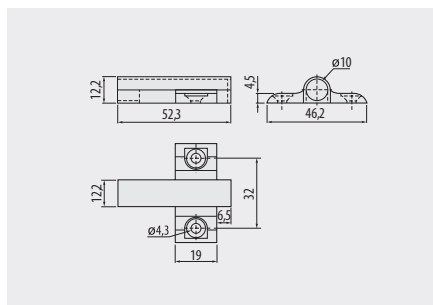

		
AM-ADAP0A-60	szary / gray / серый	tworzywo / plastic / пластмасса
AM-ADAP0A-10	biały / white / белый	



Odbojnik AM-OAD z adapterem
Bumper with adapter AM-OAD
Амортизатор с адаптером AM-OAD

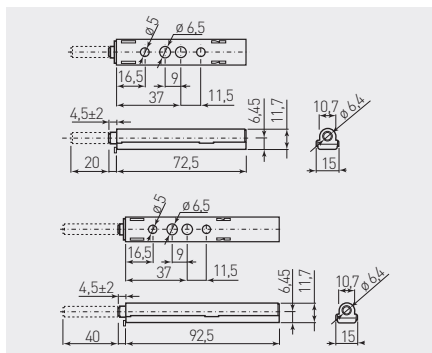

AM-OADS-DL-MG	z końcówką magnetyczną with magnetic tip магнитный наконечник	strong	dtugi / long / длинный	szary gray серый	tworzywo plastic пластмасса
AM-OADS-KR-MG		strong	krótki / short / короткий		
AM-OAD-DL-MG		standard	dtugi / long / длинный		
AM-OAD-KR-MG		standard	krótki / short / короткий		
AM-OADS-DL-GM	z końcówką kauczukową with rubber tip резиновый наконечник	strong	dtugi / long / длинный		
AM-OAD-DL-GM		standard	dtugi / long / длинный		
AM-OAD-KR-GM		strong	krótki / short / короткий		



Odbojnik AM-PL z adapterem
Bumper with adapter AM-PL
Амортизатор с адаптером AM-PL

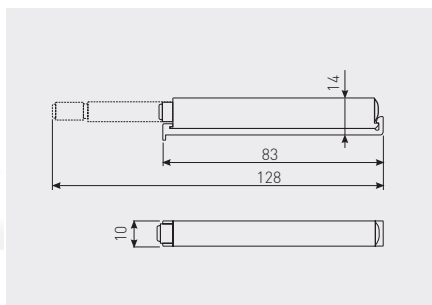

AM-PL-DL-MAG	z końcówką magnetyczną magnetic tip магнитный наконечник	szary gray серый	tworzywo plastic пластмасса
AM-PLA-DLU-0	z końcówką kauczukową with rubber tip каучуковый наконечник		



Odbojnik AM-OWP
Bumper AM-OWP
Амортизатор AM-OWP

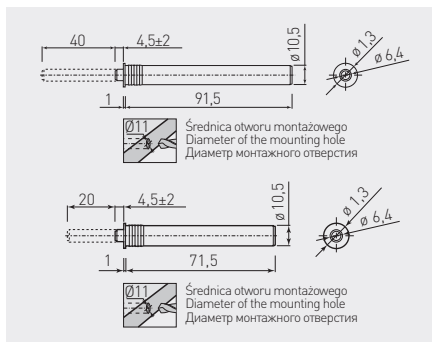

AM-OWPS-DL-MG	z końcówką magnetyczną with magnetic tip магнитный наконечник	strong	długi / long / длинный	szary gray серый	tworzywo plastic пластмасса
AM-OWPS-KR-MG		strong	krótki / short / короткий		
AM-OWP-DL-MG		standard	długi / long / длинный		
AM-OWP-KR-MG	standard	krótki / short / короткий			
AM-OWPS-DL-GM	z końcówką kauczukową with rubber tip резиновый наконечник	strong	długi / long / длинный		
AM-OWPS-KR-GM		strong	krótki / short / короткий		
AM-OWP-DL-GM		standard	długi / long / длинный		
AM-OWP-KR-GM		standard	krótki / short / короткий		



Odbojnik AM-ZAT zatrzaszkowy
Push latch AM-ZAT
Амортизатор AM-ZAT на защелке

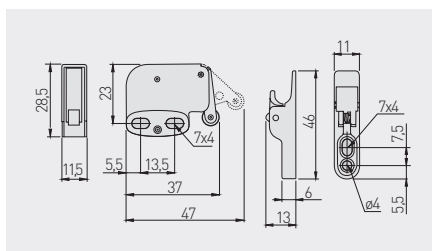

AM-ZAT-A1-10	biały white белый	stal, tworzywo steel, plastic сталь, пластмасса
--------------	-------------------------	---





Do zastosowania z zawiasem samootwierającym ZP-POH045ZE0

Dedicated for GTV self opening hinge ZP-POH045ZE0

Используется с самооткрывающейся петлей ZP-POH045ZE0

Amortyzator silikonowy
Silicone damper dots
Амортизатор силиконовый





	 mm	
AMR-BP-1003	Ø 10 x 3	100 szt. / arkusz 100 pcs / sheet
AMR-BP-0715	Ø 7 x 1,5	100 шт. / лист

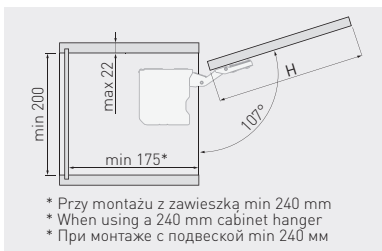

Podnośnik TOP STAYS
TOP STAYS lift
Подъёмник TOP STAYS



	Orientacyjna wysokość frontu Approximate front height Ориентировочная высота фасада	Współczynnik F Power Factor F Показатель F	Sprężyna Spring power Пружина		
PD-LIFT-LIGHT-10	250-400 mm	580-1250	light	biały / white / белый	stal steel сталь
PD-LIFT-LIGHT-80				szary / gray / серый	
PD-LIFT-MEDIUM-10	400-500 mm	960-2040	medium	biały / white / белый	
PD-LIFT-MEDIUM-80				szary / gray / серый	
PD-LIFT-STRONG-10	500 mm	1080-3500	strong	biały / white / белый	
PD-LIFT-STRONG-80				szary / gray / серый	

Współczynnik mocy F = wysokość frontu H (mm) × waga frontu łącznie z podwójną wagą uchwytu (kg)



Power Factor F = front height × front weight with doubled handle weight (kg)

Показатель мощности F = высота фасада H (мм) × вес фасада с удвоенным весом ручки (кг)

Podnośnik HEAVY DUTY
HEAVY DUTY lift
Подъёмник HEAVY DUTY

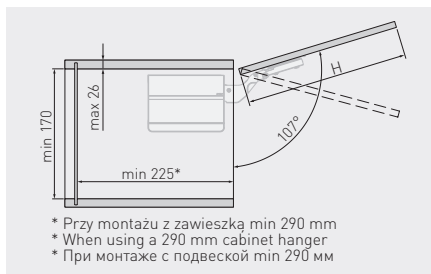
NEW



	Wysokość frontu Front height Высота фасада	Współczynnik F Power Factor F Показатель F		
PD-LIFT-HEAVY_DUTY-10	400-700 mm	3200-9000	biały / white / белый	stal, tworzywo steel, plastic
PD-LIFT-HEAVY_DUTY-80			szary / gray / серый	сталь, пластмасса

Współczynnik mocy F = wysokość frontu H (mm) × waga frontu łącznie z podwójną wagą uchwytu (kg)

Power Factor F = front height H (mm) × front weight with doubled handle weight (kg)

Показатель мощности F = высота фасада H (мм) × вес фасада с удвоенным весом ручки (кг)

Podnośnik MOVE UP gazowy
Gas stay lift MOVE UP
Подъемник газовый MOVE UP

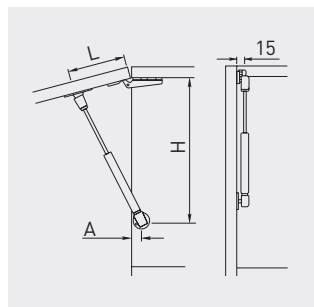

PD-G0050-N10	50 N	biały white белый	stal steel сталь
PD-G0060-N10	60 N		
PD-G0080-N10	80 N		
PD-G0100-N10	100 N		
PD-G0120-N10	120 N		
PD-G0050-N20	50 N	czarny black чёрный	
PD-G0060-N20	60 N		
PD-G0080-N20	80 N		
PD-G0100-N20	100 N		
PD-G0120-N20	120 N		



Kąt otwarcia drzwi Door opening angle Угол открывания дверей	Drzwi wpuszczane Inset door Внутренние дверцы			Drzwi bliźniacze Twin door Двойные дверцы			Drzwi nakładane Overlay door Наружные дверцы		
	H (mm)	L (mm)	A (mm)	H (mm)	L (mm)	A (mm)	H (mm)	L (mm)	A (mm)
75°	280	100	20 + grubość frontu 20 + front thicknes 20 + толщина фронта	272	100	25	264	100	25
90°	260	90		251	90	25	244	90	25
100°	250	80		242	80	25	234	80	25

Kąt otwarcia drzwi Door opening angle Угол открывания дверей	Siła podnośnika Load capacity Мощность подъемника	Wysokość drzwi (mm) / Door height (mm) / Высота дверцы (мм)			
		300	400	500	600
		Waga drzwi (kg) / Door weight (kg) / Вес дверцы (кг)			
75°	60 N	2.0	1.5	1.2	1.0
	80 N	2.7	2.0	1.6	1.4
90°	60 N	1.8	1.3	1.1	0.9
	80 N	2.4	1.8	1.4	1.2
100°	60 N	1.6	1.2	0.9	0.8
	80 N	2.1	1.6	1.2	1.0

Podnośnik gazowy standard
 Gas stay lift standard
 Подъемник газовый стандартный

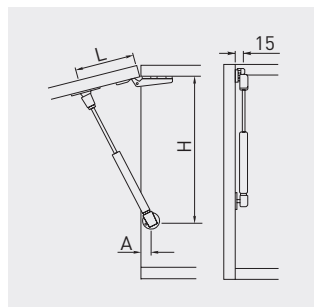

PD-G0050-N02	50 N	szary gray серый	stal steel сталь
PD-G0060-N02	60 N		
PD-G0080-N02	80 N		
PD-G0100-N02	100 N		
PD-G0120-N02	120 N		
PD-G0150-N02	150 N		



Kąt otwarcia drzwi Door opening angle Угол открывания дверей	Drzwi wpuszczane Inset door Внутренние двери			Drzwi bliźniacze Twin door Двойные двери			Drzwi nakładane Overlay door Наружные двери		
	H (mm)	L (mm)	A (mm)	H (mm)	L (mm)	A (mm)	H (mm)	L (mm)	A (mm)
75°	280	100	20 + grubość frontu 20 + front thickness 20 + толщина фронта	272	100	25	264	100	25
90°	260	90		251	90	25	244	90	25
100°	250	80		242	80	25	234	80	25

Kąt otwarcia drzwi Door opening angle Угол открывания дверей	Siła podnośnika Lift force Мощность подъемника	Wysokość drzwi (mm) / Door height (mm) / Высота двери (мм)			
		300	400	500	600
		Waga drzwi (kg) / Door weight (kg) / Вес двери (кг)			
 75°	60 N	2.0	1.5	1.2	1.0
	80 N	2.7	2.0	1.6	1.4
	100 N	3.4	2.6	2.0	1.7
	120 N	4.1	3.1	2.5	2.0
	150 N	4.7	3.5	2.9	2.4
 90°	60 N	1.8	1.3	1.1	0.9
	80 N	2.4	1.8	1.4	1.2
	100 N	3.0	2.2	1.8	1.5
	120 N	3.6	2.7	2.1	1.8
	150 N	4.1	3.2	2.3	2.1
 100°	60 N	1.6	1.2	0.9	0.8
	80 N	2.1	1.6	1.2	1.0
	100 N	2.6	1.9	1.6	1.3
	120 N	3.1	2.3	1.9	1.6
	150 N	3.5	2.6	2.2	1.9

Podnośnik gazowy z amortyzatorem
 Gas stay with buffer
 Подъемник газовый с амортизатором

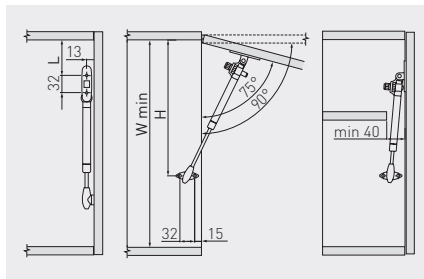

PD-G050-N02	50N	szary gray серый	stal steel
PD-G060-N02	60N		
PD-GAM080-N02	80N		
PD-GAM100-N02	100N		
PD-GAM120-N02	120N		
PD-GAM150-N02	150N		

Kąt otwarcia drzwi Door opening angle Угол открывания дверей	H (mm)	L (mm)	W (mm)
75°	295	64	315
90°	275	52	300



Kąt otwarcia drzwi Door opening angle Угол открывания дверей	Siła podnośnika Lift force Мощность подъемника	Wysokość drzwi (mm) / Door height (mm) / Высота дверцы (мм)			
		300	400	500	600
Waga drzwi (kg) / Door weight (kg) / Вес дверцы (кг)					
<p>75°</p>	50 N	1.6	1.2	1.0	0.8
	60 N	2.0	1.5	1.2	1.0
	80 N	2.7	2.0	1.6	1.4
	100 N	3.4	2.6	2.0	1.7
	120 N	4.1	3.1	2.5	2.0
	150 N	4.7	3.5	2.9	2.4
<p>90°</p>	50 N	1.5	1.1	0.9	0.7
	60 N	1.8	1.3	1.1	0.9
	80 N	2.4	1.8	1.4	1.2
	100 N	3.0	2.2	1.8	1.5
	120 N	3.6	2.7	2.1	1.8
	150 N	4.1	3.2	2.3	2.1

Podnośnik gazowy krótki
Gas stay lift short
Подъемник газовый короткий

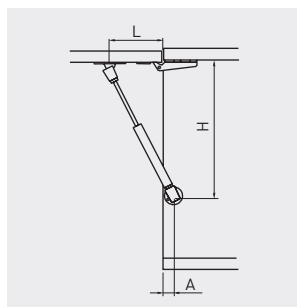

PD-G60160-N02	60 N	szary gray серый	stal steel сталь
PD-G80160-N02	80 N		



Kąt otwarcia drzwi Door opening angle Угол открывания дверей	Drzwi wpuszczane Inset door Внутренние дверцы			Drzwi bliźniacze Twin door Двойные дверцы			Drzwi nakładane Overlay door Наружные дверцы		
	H (mm)	L (mm)	A (mm)	H (mm)	L (mm)	A (mm)	H (mm)	L (mm)	A (mm)
75°	188	70	20 + grubość frontu 20 + front thicknes 20 + толщина фронта	180	70	20	172	70	20
90°	176	60		167	60	20	160	60	20
100°	172	50		164	50	20	154	50	20

Kąt otwarcia drzwi Door opening angle Угол открывания дверей	Siła podnośnika Lift force Мощность подъемника	Wysokość drzwi (mm) / Door height (mm) / Высота дверцы (мм)			
		300	400	500	600
		Waga drzwi (kg) / Door weight (kg) / Вес дверцы (кг)			
75° 	60 N	2.0	1.5	1.2	1.0
	80 N	2.7	2.0	1.6	1.4
90° 	60 N	1.8	1.3	1.1	0.9
	80 N	2.4	1.8	1.4	1.2
100° 	60 N	1.6	1.2	0.9	0.8
	80 N	2.1	1.6	1.2	1.0

Podnośnik DESIGN mechaniczny
Mechanical stay lift DESIGN
Подъемник механический DESIGN



PD-GPD01-001	chrom / chrome / хром	stal steel сталь
PD-GPD02-002	satyna / satin / сатин	
PD-GPD03-005	aluminium / алюминий	



Podnośnik do klap
Flap lift
Подъемник фасада



100°

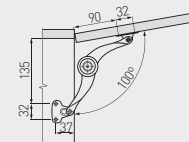

Plaszczyzna wewn. boku
Inner side surface
Поверхность боковой стенки

Podnośnik do klap
Flap lift
Подъемник фасада



75°

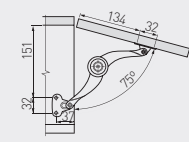

Plaszczyzna wewn. boku
Inner side surface
Поверхность боковой стенки

Podnośnik do klap
Flap lift
Подъемник фасада



90°

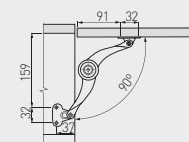

Plaszczyzna wewn. boku
Inner side surface
Поверхность боковой стенки

Wizualizacja dla zawiasów barkowych
Drop Down Flap Stay
Визуализация для барных петель



90°

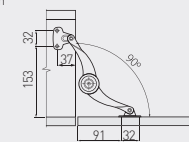

Plaszczyzna wewn. boku
Inner side surface
Поверхность боковой стенки

Wykres orientacyjnych wartości maksymalnego ciężaru w zależności od wysokości klap.

Maximum weight depending on the flap height

Максимальный вес фасада зависит от его высоты

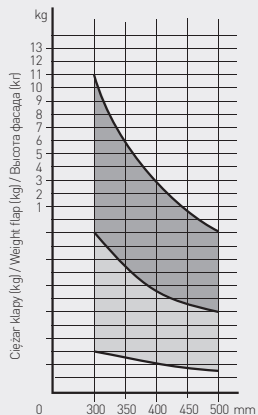
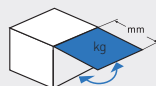

Wysokość klap [mm]
Flap height [mm]
Высота фасада [mm]

- 1 podnośnik
1 stay lift
1 подъемник
- 2 podnośniki
2 stay lifts
2 подъемника

Podnośnik mechaniczny standard
 Mechanical stay lift standard
 Подъемник механический стандартный



PD-PD000-001	chrom / chrome / хром	stal / steel / сталь
--------------	-----------------------	----------------------



Podnośnik do klap
 Flap lift
 Поддержка фасада



100°

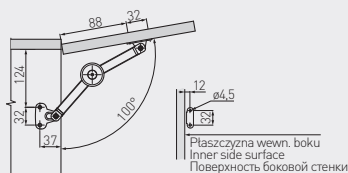

Wykres orientacyjnych wartości maksymalnego ciężaru w zależności od wysokości kłapy.

Maximum weight depending on the flap height.

Максимальный вес фасада зависит от его высоты

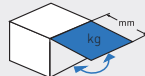

Podnośnik do klap
 Flap lift
 Поддержка фасада



75°

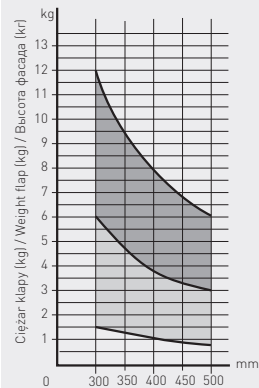
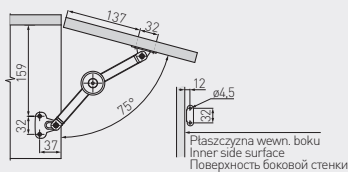

Podnośnik do klap
 Flap lift
 Поддержка фасада



90°

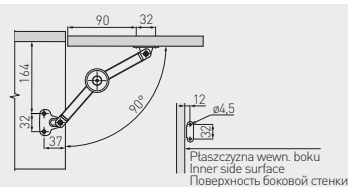

Rozwórka do klap
 Wizualizacja dla zawiasu barkowego
 Drop Down Flap Stay
 Поддержка фасада.
 Визуализация для барных петель



90°

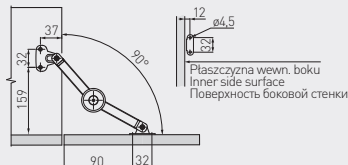

Wysokość kłapy (mm)
 Flap height (mm)
 Высота фасада (мм)

- 1 podnośnik
1 stay lift
1 подъемник
- 2 podnośniki
2 stay lifts
2 подъемника

Amortyzator VIM do klap barkowych, krótki
 VIM stay lift for drop down cabinet doors - short
 Амортизатор барный, короткий VIM



Produkt kompatybilny z zawiasem barkowym: PD-MD-ZB

Compatible with flap hinge: PD-MD-ZB

Продукт совместим с барной петлей: PD-MD-ZB



PD-MDLIFT-P1-D



szary
gray
серый



stal
steel
сталь



Orientacyjna tabela wartości doboru podnośników, w zależności od szerokości i wysokości klapy.

Maximum weight depending on the flap height.

Таблица подбора амортизатора в зависимости от ширины и высоты фасада.

Wysokość Height Высота	Szerokość (mm) / Width (mm) / Ширина (мм)			
	600 mm	700 mm	800 mm	900 mm
250 mm	1	1	2	2
260 mm				
270 mm				
280 mm				
290 mm				
300 mm	2	2	2	2
310 mm				
320 mm				
330 mm				
340 mm				

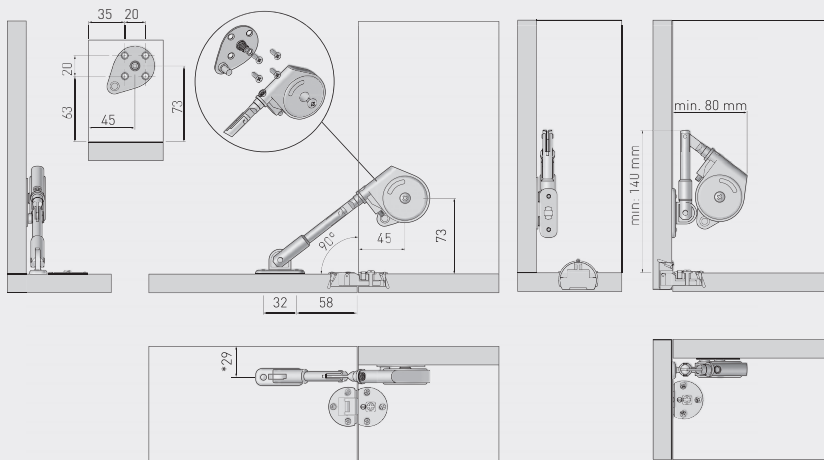

- * Przy pełnym naciżeniu na korpus # 18 mm
- * When fully applied to the cabinet # 18 mm
- * При полном соприкосновении с внутренней поверхностью стенки корпуса 18 мм

Amortyzator VIM do klap barkowych, długi
 VIM stay lift for drop down cabinet doors - long
 Амортизатор барный VIM, длинный



Produkt kompatybilny z zawiasem barkowym: PD-MD-ZB

Compatible with flap hinge: PD-MD-ZB

Продукт совместим с барной петлей: PD-MD-ZB



PD-MDLIFT-P2-D



szary
gray
серый



stal
steel
сталь



Orientacyjna tabela wartości doboru podnośników, w zależności od szerokości i wysokości kłapy.

Maximum weight depending on the flap height.

Таблица подбора амортизатора в зависимости от ширины и высоты фасада.

Wysokość Height Высота	Szerokość / Width / Ширина			
	600 mm	700 mm	800 mm	900 mm
	Ilość amortyzatorów Number of lifts Количество амортизаторов			
350 mm	1	2	2	2
360 mm				
370 mm				
380 mm				
390 mm				
400 mm				

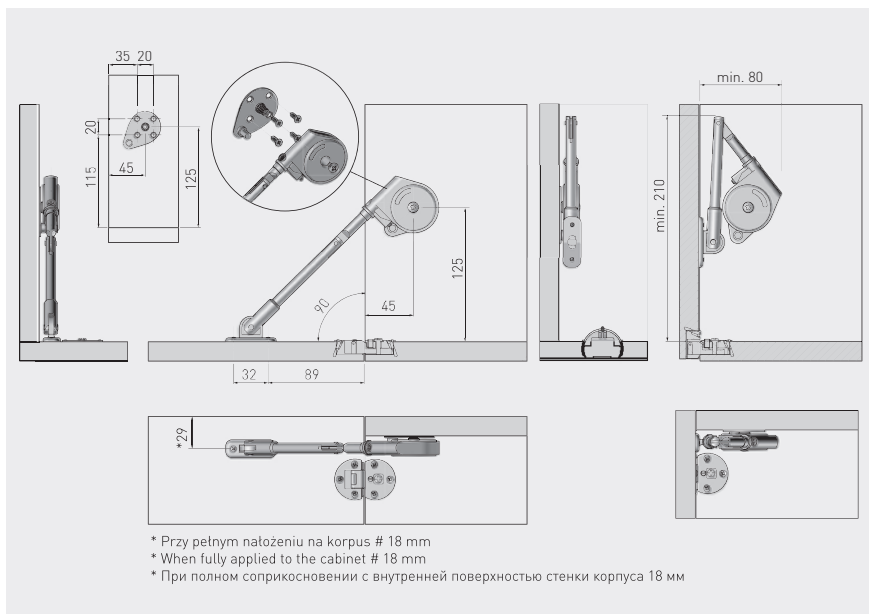

Amortyzator olejowy do klap barkowych
Oil stay lift for drop down cabinet doors
Амортизатор маслянный барный

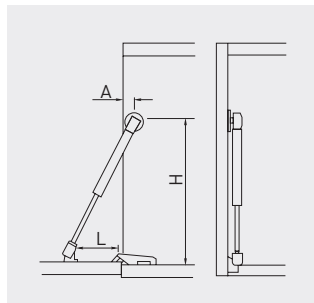

PD-ECGDL-060	60 N	szary gray серый	stal steel сталь
PD-ECGDL-080	80 N		
PD-ECGDL-150	150 N		



Kąt otwarcia drzwi Door opening angle Угол открывания дверей	Drzwi wpuszczane Inset door Внутренние дверцы			Drzwi bliźniacze Twin door Двойные дверцы			Drzwi nakładane Overlay door Наружные дверцы		
	H (mm)	L (mm)	A (mm)	H (mm)	L (mm)	A (mm)	H (mm)	L (mm)	A (mm)
90°	260	90	45	253	90	25	246	90	25

Kąt otwarcia drzwi Door opening angle Угол открывания дверей	Siła podnośnika Lift force Мощность подъемника	Wysokość drzwi (mm) / Door height (mm) / Высота дверцы (мм)			
		300	400	500	600
		Waga drzwi (kg) / Door weight (kg) / Вес дверцы (кг)			
90°	60 N	1.8	1.3	1.1	0.9
	80 N	2.4	1.8	1.4	1.2
	150 N	4.1	3.2	2.3	2.1

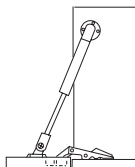

Prowadnica dolnego montażu ze spawalniczem 3DSLIDE
 Undermount drawer slide with soft closing 3DSLIDE
 Направляющая нижнего монтажа с доводчиком 3DSLIDE



Rozstaw otworów montażowych
 Mounting dimensions
 Монтажные отверстия

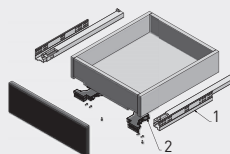
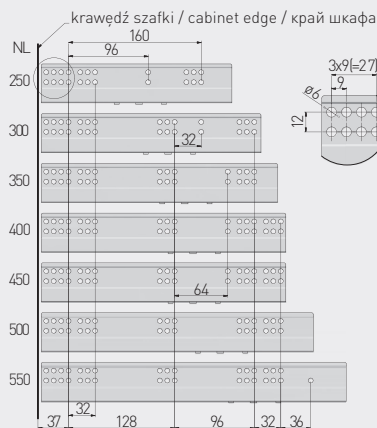

1. prowadnica lewa/prawa
 drawer slide L/R
 направляющая Л/П
2. sprzęgło lewe/prawe + wkręty
 locking device L / R + screws
 крепления фасада Л/П + саморезы

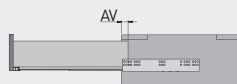

NL = długość nominalna prowadnicy
 nominal slide length
 номинальная длина направляющей

AV = strata wysuwu
 extension loss
 потеря на выдвигении

Uwagi montażowe: dla prawidłowego działania szuflady jej szerokość nie może przekraczać długości nominalnej prowadnicy.
 Mounting information: for proper drawer operation, the width of the drawer can not exceed the nominal slide length.
 Техническое примечание: ширина ящика не должна превышать длину направляющей.

	L mm	AV mm		Kg		
PB-3DSLIDE-250	250	25	pełny full полное	40	ocynk galvanized гальваника	stal
PB-3DSLIDE-270	270					
PB-3DSLIDE-300	300					
PB-3DSLIDE-350	350					
PB-3DSLIDE-400	400					
PB-3DSLIDE-450	450					
PB-3DSLIDE-500	500					
PB-3DSLIDE-550	550					

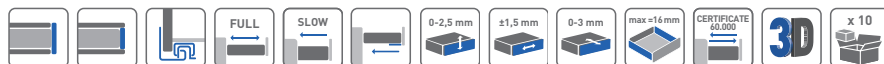

Prowadnica dolnego montażu ze spowalniaczem 0SHX
 Undermount drawer slide with soft closing 0SHX
 Направляющая нижнего монтажа полного выдвижения с доводчиком 0SHX



Rozstaw otworów montażowych
 Mounting dimensions
 Монтажные отверстия

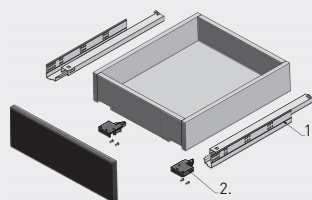
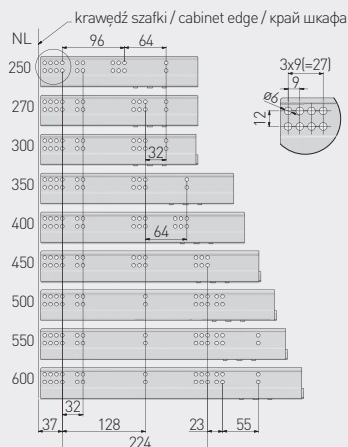

1. prowadnica lewa/prawa
 drawer slide L/R
 направляющая Л/П
2. sprzęgło lewe/prawe + wkręty
 locking device L/R + screws
 крепления фасада Л/П + саморезы

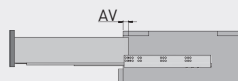

NL = długość nominalna prowadnicy
 nominal slide length
 номинальная длина направляющей

AV = strata wysunięciu
 extension loss
 потеря на выдвижении

Uwagi montażowe: dla prawidłowego działania szuflady jej szerokość nie może przekraczać długości nominalnej prowadnicy.
 Mounting information: for proper drawer operation, the width of the drawer can not exceed the nominal slide length.
 Техническое примечание: ширина ящика не должна превышать длину направляющей.

		mm	mm		kg		
PB-0SHX-250-A		250					
PB-0SHX-270-A		270					
PB-0SHX-300-A		300					
PB-0SHX-350-A		350					
PB-0SHX-400-A		400	16	pełny full полное	35	ocynk galvanized гальваника	stal steel сталь
PB-0SHX-450-A		450					
PB-0SHX-500-A		500					
PB-0SHX-550-A		550					
PB-0SHX-600-A		600					



Prowadnica dolnego montażu ze spowalniczem 0SHX-18
 Undermount drawer slide with soft closing 0SHX-18
 Направляющая нижнего монтажа с доводчиком 0SHX-18



Rozstaw otworów montażowych
 Mounting dimensions
 Монтажные отверстия

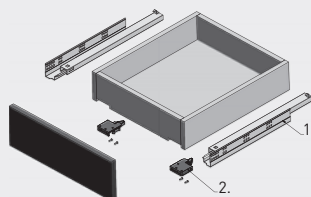
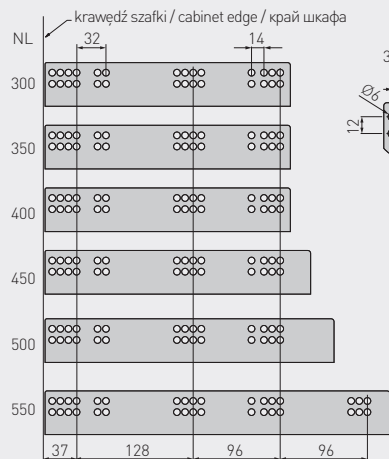

1. prowadnica lewa/prawa
 drawer slide L/R
 направляющая Л/П
2. sprzeczko lewe/prawe + wkręty
 locking device L / R + screws
 крепления фасада Л/П + саморезы

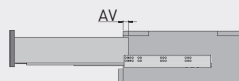

NL = długość nominalna prowadnicy
 nominal slide length
 номинальная длина направляющей

AV = strata wysuwu
 extension loss
 потеря на выдвигании

Uwagi montażowe: dla prawidłowego działania szuflady jej szerokość nie może przekraczać długości nominalnej prowadnicy.
 Mounting information: for proper drawer operation, the width of the drawer can not exceed the nominal slide length.
 Техническое примечание: ширина ящика не должна превышать длину направляющей.

	 L mm	 AV mm		 kg		
PB-0SHX18-300-H	300	16	pełny full полное	30	osynek galwanizowany гальваніка	stal steel сталь
PB-0SHX18-350-H	350					
PB-0SHX18-400-H	400					
PB-0SHX18-450-H	450					
PB-0SHX18-500-H	500					
PB-0SHX18-550-H	550					



Prowadnica dolnego montażu ze spowalniczem 0SHX-18 3D
 Undermount drawer slide with soft closing 0SHX-18 3D
 Направляющая нижнего монтажа с доводчиком 0SHX-18 3D

NEW



NL krawędź szafki / cabinet edge / край шкафа

1. prowadnica lewa/prawa drawer slide L/R направляющая Л/П
2. sprzęgło lewe/prawe + wkręty locking device L/R + screws крепления фасада Л/П + саморезы

AV

NL = długość nominalna prowadnicy nominal slide length
 номинальная длина направляющей
 AV = strata wysuwu extension loss
 потеря на выдвигении

Uwagi montażowe: dla prawidłowego działania szuflady jej szerokość nie może przekraczać długości nominalnej prowadnicy.
 Mounting information: for proper drawer operation, the width of the drawer can not exceed the nominal slide length.
 Техническое примечание: ширина ящика не должна превышать длину направляющей.

	L mm	AV mm		kg		
PB-3D0SHX18-300-H	300	16	petny full полное	30		stal galwanizowana сталь
PB-3D0SHX18-350-H	350					
PB-3D0SHX18-400-H	400					
PB-3D0SHX18-450-H	450					
PB-3D0SHX18-500-H	500					
PB-3D0SHX18-550-H	550					



Prowadnica dolnego montażu ze spowalniczem S10C
 Undermount drawer slide with soft closing S10C
 Направляющая нижнего монтажа с доводчиком S10C



Kolek blokujący (zabezpieczenie przed wypadnięciem szuflady)
 Blocking peg [prevents drawer from falling out]
 Ограничитель (защита от выпадения ящика)

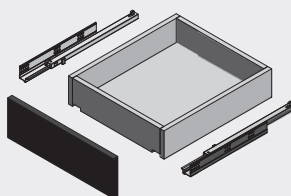
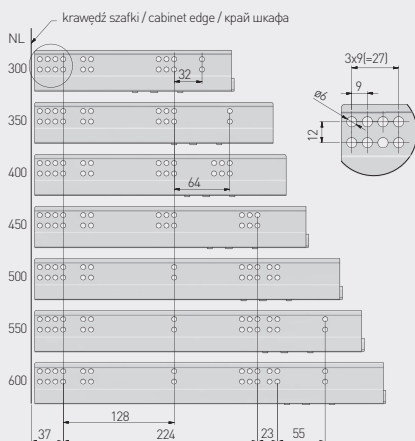

NL = długość nominalna prowadnicy
 nominal slide length
 номинальная длина направляющей
 AV = strata wysuwu
 extension loss
 потеря на выдвигании

Uwagi montażowe: dla prawidłowego działania szuflady jej szerokość nie może przekraczać długości nominalnej prowadnicy.
 Mounting information: for proper drawer operation, the width of the drawer can not exceed the nominal slide length.
 Техническое примечание: ширина ящика не должна превышать длину направляющей.

	L mm	AV mm	kg			
PB-S10C300HX	300	28	petny full полное	25	ocynk galvanized гальваника	stal steel сталь
PB-S10C350HX	350					
PB-S10C400HX	400					
PB-S10C450HX	450					
PB-S10C500HX	500					
PB-S10C550HX	550					
PB-S10C600HX	600					



Prowadnica dolnego montażu push to open 0FPO
 Undermount drawer slide push to open 0FPO
 Направляющая нижнего монтажа push to open 0FPO



Możliwość zastosowania stabilizatora
 PB-D-P20STAB
 Can be used with stabilizer
 PB-D-P20STAB
 Возможность использования стабилизатора
 PB-D-P20STAB

NL = krawędź szafki / cabinet edge / край шкафа

NL = długość nominalna prowadnicy
 nominal slide length
 номинальная длина направляющей

AV = strata wysuwu
 extension loss
 потеря на выдвигании

Uwagi montażowe: dla prawidłowego działania szuflady jej szerokość nie może przekraczać długości nominalnej prowadnicy.
 Mounting information: for proper drawer operation, the width of the drawer can not exceed the nominal slide length.
 Техническое примечание: ширина ящика не должна превышать длину направляющей.

	L mm	AV mm		kg		
PB-0FPO-250	250	26	pełny full полное	25	ocynk galvanized гальваника	stal steel сталь
PB-0FPO-270	270					
PB-0FPO-300	300					
PB-0FPO-350	350					
PB-0FPO-400	400					
PB-0FPO-450	450					
PB-0FPO-500	500					
PB-0FPO-550	550					
PB-0FPO-600	600					



Prowadnica dolnego montażu ze spawalniczem GCHX

Undermount drawer slide with soft closing GCHX

Направляющая нижнего монтажа неполного выдвижения с доводчиком GCHX



krawędź szafki / cabinet edge / край шкафа

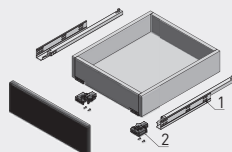
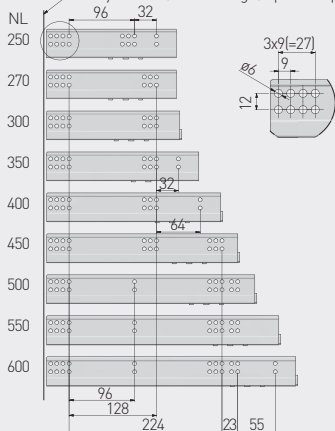



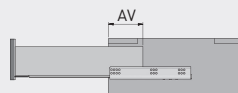



1. prowadnica lewa/prawa
drawer slide L/R
направляющая Л/П
2. sprzęgło lewe/prawe + wkręty
locking device L/R + screws
крепления фасада Л/П + саморезы



NL = długość nominalna prowadnicy
nominal slide length
номинальная длина направляющей

AV = strata wysuwu
extension loss
потеря на выдвижении

Uwagi montażowe: dla prawidłowego działania szuflady jej szerokość nie może przekraczać długości nominalnej prowadnicy.
Mounting information: for proper drawer operation, the width of the drawer can not exceed the nominal slide length.
Техническое примечание: ширина ящика не должна превышать длину направляющей.

		 L mm	 AV mm		 kg		
PB-GCHX-250		250	98,5	niepełny partial неполное	25	ocynk galvanized гальваника	stal steel сталь
PB-GCHX-270		270					
PB-GCHX-300		300					
PB-GCHX-350		350					
PB-GCHX-400		400	118,5				
PB-GCHX-450		450					
PB-GCHX-500		500	138,5				
PB-GCHX-550		550					
PB-GCHX-600		600					







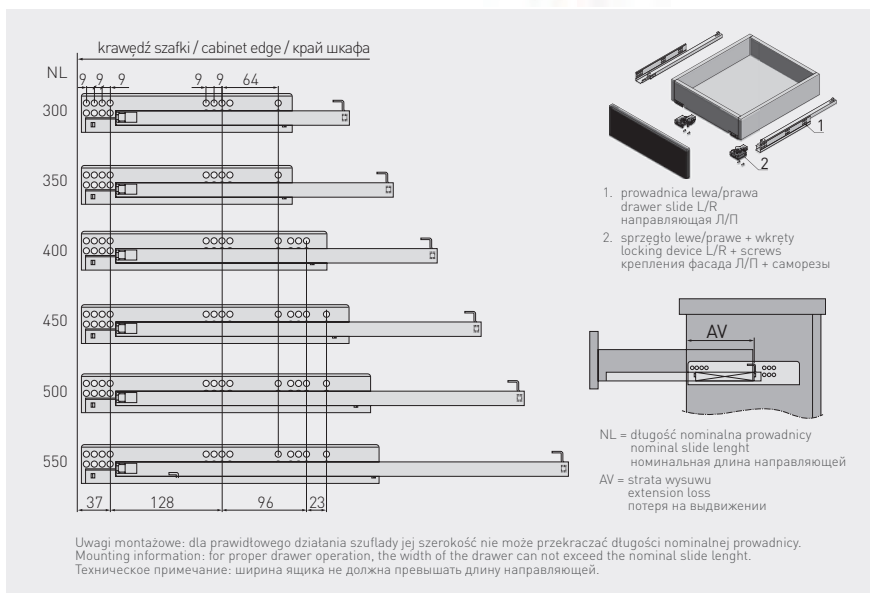

Prowadnica dolnego montażu ze spowalniczem GCHX-H

Undermount drawer slide with soft closing GCHX-H

Направляющая нижнего монтажа неполное выдвижение с доводчиком GCHX-H



	 L mm	 AV mm				
PB-GCHX-300-H	300	83	niepełny partial неполное	30	ocynk galvanized гальваника	stal steel сталь
PB-GCHX-350-H	350					
PB-GCHX-400-H	400	111				
PB-GCHX-450-H	450					
PB-GCHX-500-H	500					
PB-GCHX-550-H	550					



Prowadnice dolnego montażu ze spowalniczem G10HX

Undermount drawer slide with soft closing G10HX

Направляющая нижнего монтажа неполное выдвижение с доводчиком G10HX





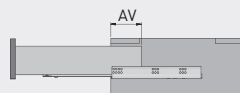
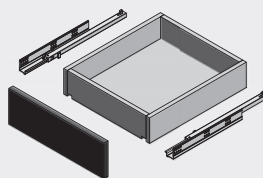
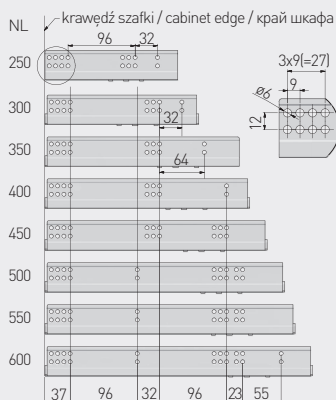



Kotek blokujący (zabezpieczenie przed wypadnięciem szuflady)
Blocking peg (prevents drawer from falling out)
Ограничитель (защита от выпадения ящика)



NL = długość nominalna prowadnicy
nominal slide length
номинальная длина направляющей
AV = strata wysuwu
extension loss
потеря на выдвижении

Uwagi montażowe: dla prawidłowego działania szuflady jej szerokość nie może przekraczać długości nominalnej prowadnicy.
Mounting information: for proper drawer operation, the width of the drawer can not exceed the nominal slide length.
Техническое примечание: ширина ящика не должна превышать длину направляющей.

		 L mm	 AV mm			
PB-G10HX250		250	86,5	25	ocynk galvanized	stal steel
PB-G10HX300		300				
PB-G10HX350		350				
PB-G10HX400		400	106,5			
PB-G10HX450		450				
PB-G10HX500		500	126,5			
PB-G10HX550		550				
PB-G10HX600		600				



Prowadnica dolnego montażu ze spowalniczem Q10HX

Undermount drawer slide with soft closing Q10HX

Направляющая нижнего монтажа неполное выдвижение с доводчиком Q10HX

NEW

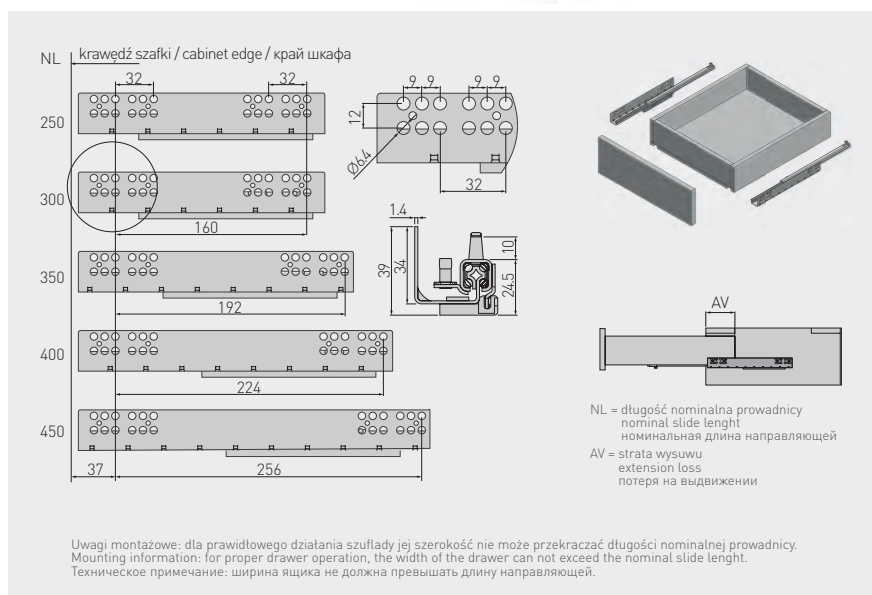

	L mm	AV mm	kg		
PB-Q10HX250	250	64	20	ocynk galvanized	stal steel
PB-Q10HX300	300				
PB-Q10HX350	350	76	20	galwanika	stal
PB-Q10HX400	400	88			
PB-Q10HX450	450	100			



Prowadnica dolnego montażu push to open GAPO
 Undermount drawer slide push to open GAPO
 Направляющая нижнего монтажа неполное выдвижение push to open GAPO



Możliwość zastosowania stabilizatora PB-D-P20STAB
 Can be used with stabilizer PB-D-P20STAB
 Возможность использования стабилизатора PB-D-P20STAB

NL krawędź szafki / cabinet edge / край шкафа

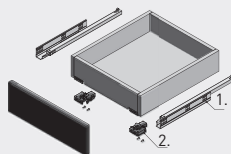
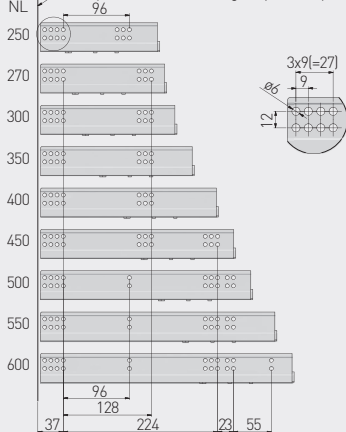



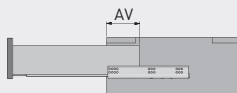



1. prowadnica lewa/prawa drawer slide L/R направляющая Л/П
2. sprzęgło lewe/prawe + wkręty locking device L / R + screws крепления фасада Л/П + саморезы



NL = długość nominalna prowadnicy nominal slide length номинальная длина направляющей
 AV = strata wysuwu extension loss потеря на выдвижении

Uwagi montażowe: dla prawidłowego działania szuflady jej szerokość nie może przekraczać długości nominalnej prowadnicy.
 Mounting information: for proper drawer operation, the width of the drawer can not exceed the nominal slide length.
 Техническое примечание: ширина ящика не должна превышать длину направляющей.

		 L mm	 AV mm		 kg		
PB-GAPO-250		250	98,5	niepełny partial неполное	25	ocynk galvanized гальваника	stal steel сталь
PB-GAPO-270		270					
PB-GAPO-300		300					
PB-GAPO-350		350					
PB-GAPO-400		400	118,5				
PB-GAPO-450		450					
PB-GAPO-500		500	138,5				
PB-GAPO-550		550					
PB-GAPO-600		600					



Prowadnica kulkowa H53
 Ball bearing slide H53
 Шариковая направляющая H53

NEW

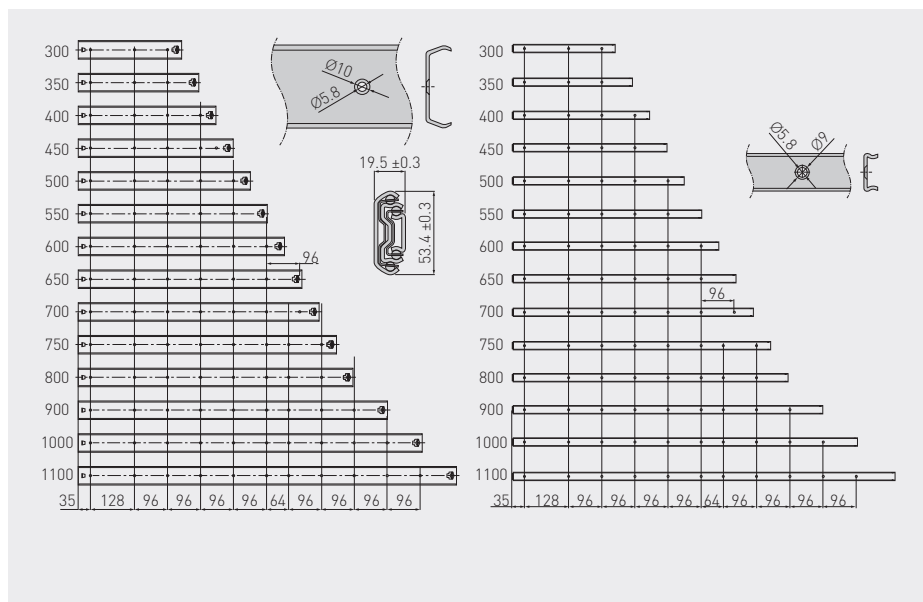

		 L mm	 AV mm	 kg		
PK-0-H53-300		300	-			
PK-0-H53-350		350	-			
PK-0-H53-400		400	-	petny full полное	80	ocynk galvanized гальваника
PK-0-H53-450		450	-			
PK-0-H53-500		500	-			
PK-0-H53-550		550	-			
PK-0-H53-600		600	-			

		 L mm	 AV mm	 kg		
PK-0-H53-650		650	-			
PK-0-H53-700		700	-			
PK-0-H53-750		750	-	petny full полное	80	ocynk galvanized гальваника
PK-0-H53-800		800	-			
PK-0-H53-900		900	-			
PK-0-H53-1000		1000	-			
PK-0-H53-1100		1100	-			



Prowadnica kulkowa VERSALITE PLUS ze spowalniaczem H45
 Ball bearing slide VERSALITE PLUS with soft closing H45
 Шариковая направляющая VERSALITE PLUS с доводчиком H45





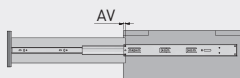
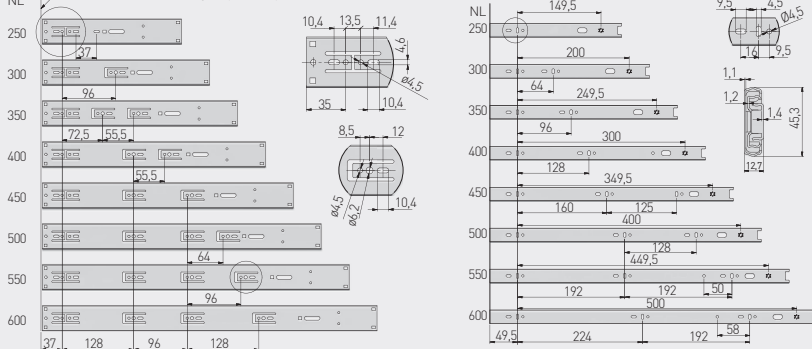

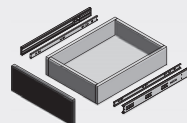

NL ← krawędź szafki / cabinet edge / край шкафа



NL = długość nominalny prowadnicy
 nominal slide length
 номинальная длина направляющей
 AV = strata wysuwu
 extension loss
 потеря на выдвижении



Uwagi montażowe: dla prawidłowego działania szuflady jej szerokość nie może przekraczać długości nominalnej prowadnicy.
 Mounting information: for proper drawer operation, the width of the drawer can not exceed the nominal slide length.
 Техническое примечание: ширина ящика не должна превышать длину направляющей.





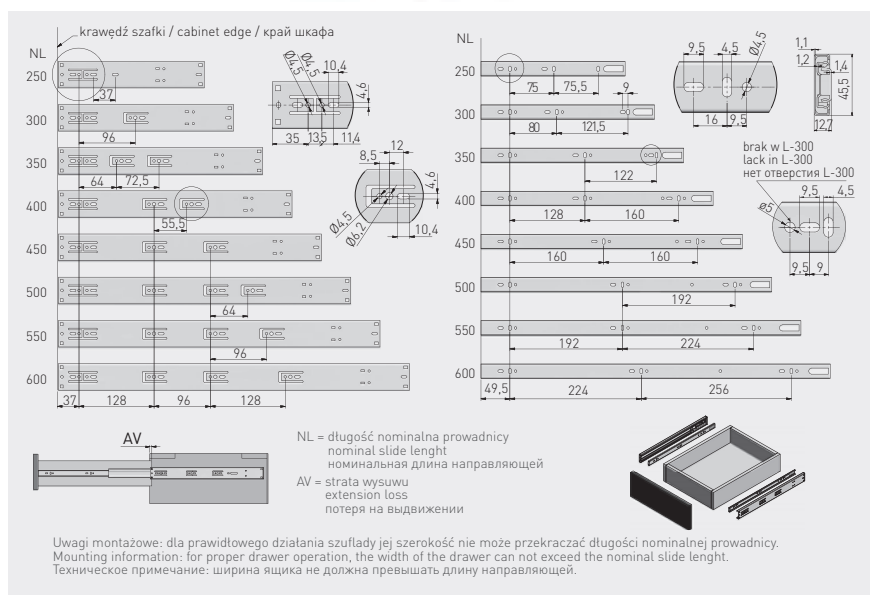

		 L mm	 AV mm		 kg		
PK-L-H45-250		250*	102	petny full полное	30	ocynk galvanized гальваника	stal steel сталь
PK-L-H45-300		300*	52				
PK-L-H45-350		350*	35				
PK-L-H45-400		400*	20				
PK-L-H45-450		450	4				
PK-L-H45-500		500					
PK-L-H45-550		550					
PK-L-H45-600		600					

* Brak pełnego wysuwu / Not full extension / Неполное выдвижение



Prowadnica kulkowa VERSALITE ze spowalniczem H45
 Ball bearing slide VERSALITE with soft closing H45
 Шариковая направляющая VERSALITE с доводчиком H45









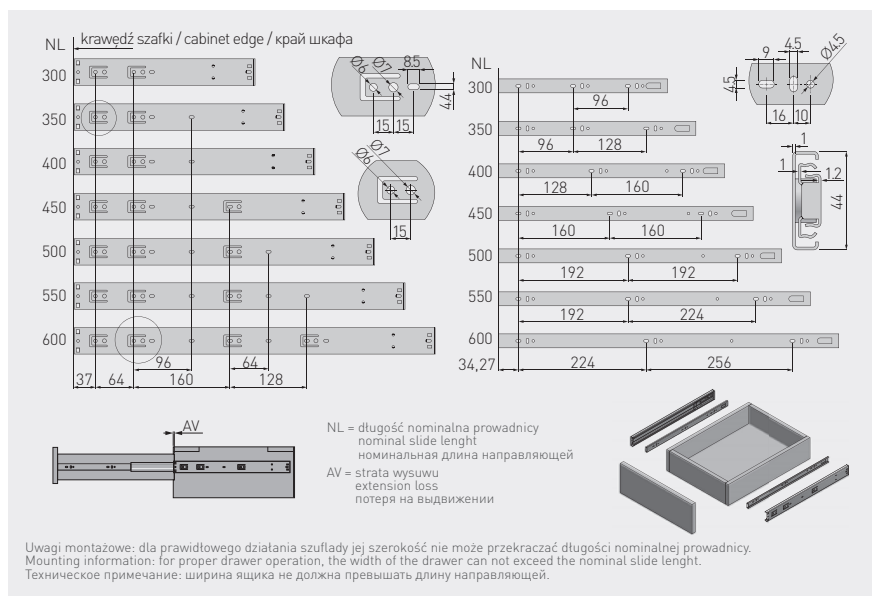

		 L mm	 AV mm		 kg		
PK-L-H45-250-A		250*	55	petny full полное	30	ocynk galvanized гальваника	stal steel сталь
PK-L-H45-300-A		300	15				
PK-L-H45-350-A		350	5				
PK-L-H45-400-A		400					
PK-L-H45-450-A		450					
PK-L-H45-500-A		500	0				
PK-L-H45-550-A		550					
PK-L-H45-600-A		600					

* Brak pełnego wysuwu / Not full extension / Неполное выдвижение



Prowadnica kulkowa VERSALITE LIGHT ze spawalniczem H45
 Ball bearing slide VERSALITE LIGHT with soft closing H45
 Шариковая направляющая VERSALITE LIGHT с доводчиком H45



		 L mm	 AV mm		 kg		
PK-L-H45-300-GX		300	50	pełny full полное	25	ocynk galvanized гальваника	stal steel сталь
PK-L-H45-350-GX		350	20				
PK-L-H45-400-GX		400					
PK-L-H45-450-GX		450					
PK-L-H45-500-GX		500					
PK-L-H45-550-GX		550					
PK-L-H45-600-GX		600					



Prowadnica kulkowa z samodociąganiem H45
 Ball bearing slide with self closing H45
 Шариковая направляющая с фиксатором H45

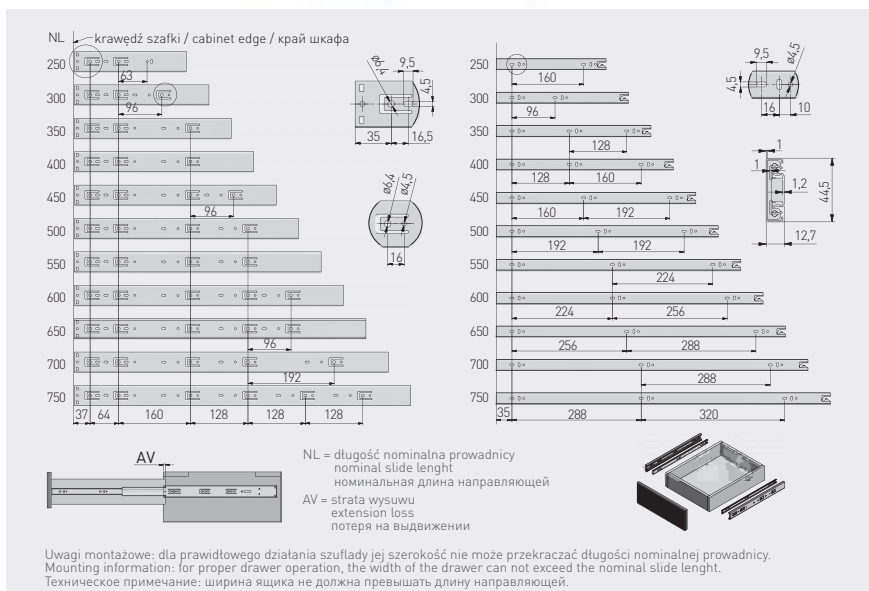

	L mm	AV mm		kg			
PK-S-H45-250	250*	22	petny full полное	35	ocynk galvanized гальваника	stal steel	15
PK-S-H45-300	300						
PK-S-H45-350	350						
PK-S-H45-400	400						
PK-S-H45-450	450						
PK-S-H45-500	500						
PK-S-H45-550	550						10
PK-S-H45-600	600						
PK-S-H45-650	650						
PK-S-H45-700	700						

* Brak pełnego wysuwu / Not full extension / Неполное выдвижение



Prowadnica kulkowa push to open H45
 Ball bearing slide push to open H45
 Шариковая направляющая push to open H45



Możliwość zastosowania stabilizatora
 PB-D-P20STAB
 Can be used with stabilizer
 PB-D-P20STAB
 Возможность использования стабилизатора
 PB-D-P20STAB

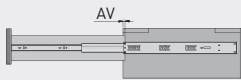
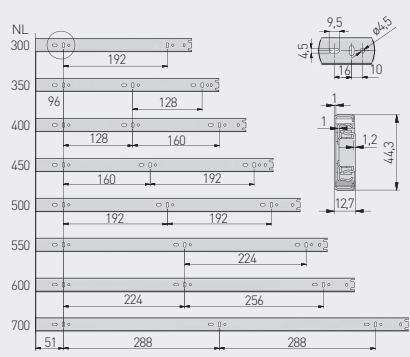
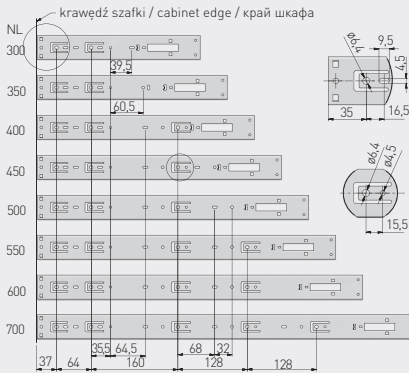

NL = długość nominalna prowadnicy
 nominal slide length
 номинальная длина направляющей
 AV = strata wysuwu
 extension loss
 потеря на выдвигании

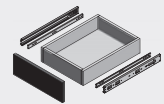

Uwagi montażowe: dla prawidłowego działania szuflady jej szerokość nie może przekraczać długości nominalnej prowadnicy.
 Mounting information: for proper drawer operation, the width of the drawer can not exceed the nominal slide length.
 Техническое примечание: ширина ящика не должна превышать длину направляющей.

	L mm	AV mm		kg			
PK-P-0H45-300A	300*	20	pełny full полное	25			15
PK-P-0H45-350A	350						
PK-P-0H45-400A	400						
PK-P-0H45-450A	450						
PK-P-0H45-500A	500						
PK-P-0H45-550A	550						
PK-P-0H45-600A	600	10					
PK-P-0H45-700A	700						







* Brak pełnego wysuwu / Not full extension / Неполное выдвигание

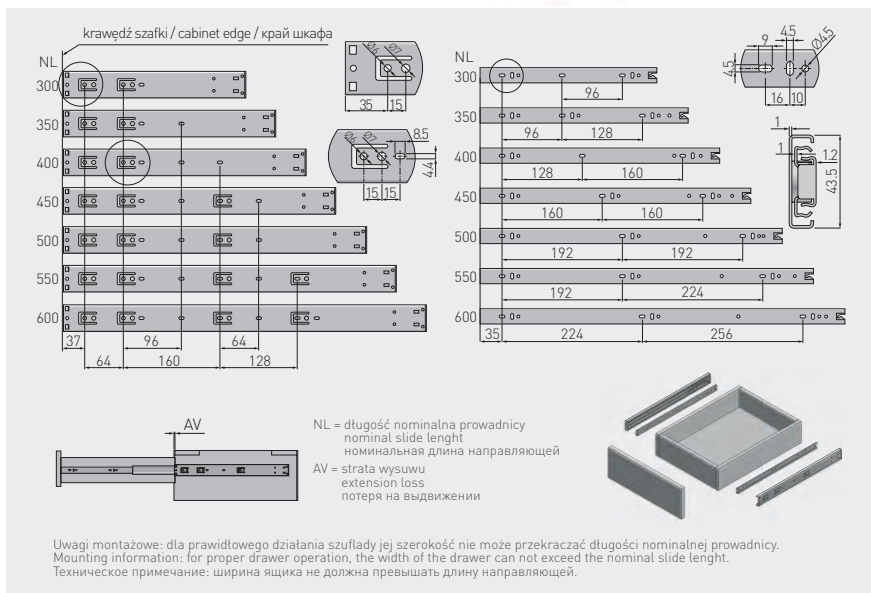

Prowadnica kulkowa push to open H45 GX
 Ball bearing slide push to open H45 GX
 Шариковая направляющая push to open H45 GX

NEW



		 L mm	 AV mm		 kg		
PK-P-H45-300-GX		300	30	pełny full полное	25	ocynk galvanized гальваника	stal steel сталь
PK-P-H45-350-GX		350					
PK-P-H45-400-GX		400					
PK-P-H45-450-GX		450					
PK-P-H45-500-GX		500					
PK-P-H45-550-GX		550					
PK-P-H45-600-GX		600					



Prowadnica kulkowa H45 PRESTIGE
Ball bearing slide H45 PRESTIGE
Шариковая направляющая H45 RESTIGE





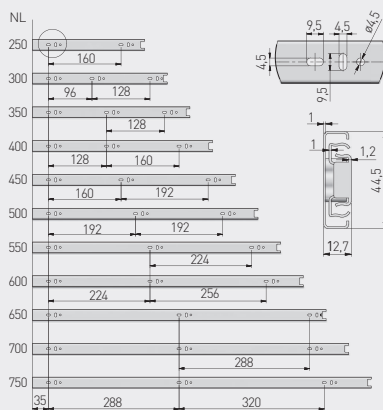
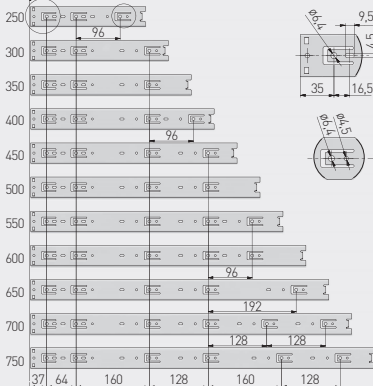

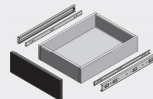

NL = krawędź szafki / cabinet edge / край шкафа



NL = długość nominalna prowadnicy
nominal slide length
номинальная длина направляющей
AV = strata wysuwu
extension loss
потеря на выдвигании



Uwagi montażowe: dla prawidłowego działania szuflady jej szerokość nie może przekraczać długości nominalnej prowadnicy.
Mounting information: for proper drawer operation, the width of the drawer can not exceed the nominal slide length.
Техническое примечание: ширина ящика не должна превышать длину направляющей.

		 L mm	 AV mm	 kg				
PK-0-H45-250		250	-	petny full полное	35	ocynk galvanized гальваника	stal steel сталь	15
PK-0-H45-300		300						
PK-0-H45-350		350						
PK-0-H45-400		400						
PK-0-H45-450		450						
PK-0-H45-500		500						
PK-0-H45-550		550						10
PK-0-H45-600		600						
PK-0-H45-650		650						
PK-0-H45-700		700						



Prowadnica kulkowa H45 GX1
Ball bearing slide H45 GX1
Шариковая направляющая H45 GX1

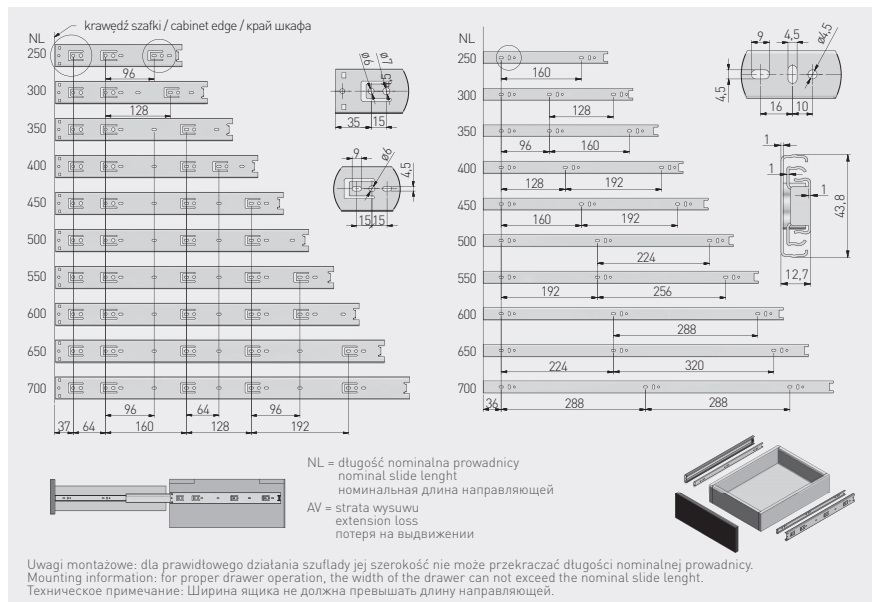





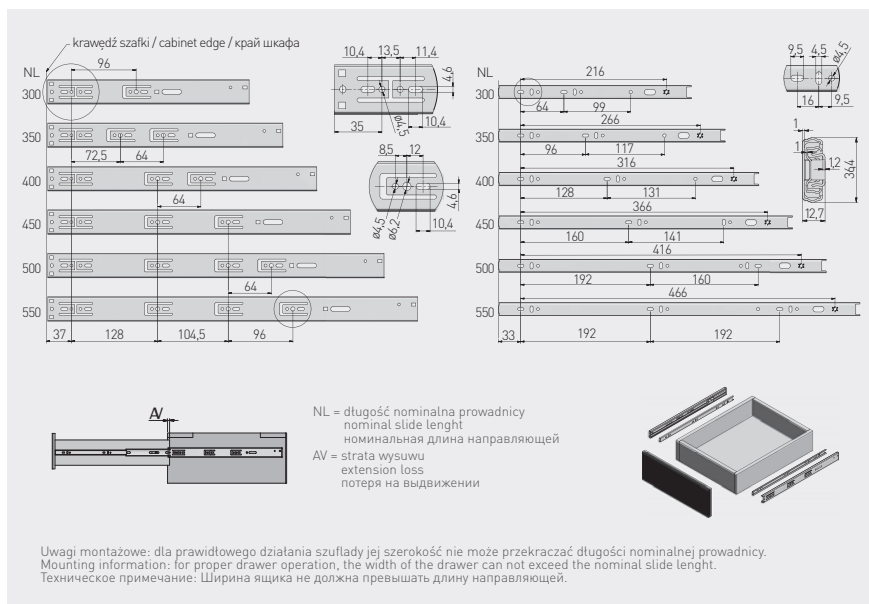

	L mm	AV mm		kg		
PK-0H45250GX1	250	5	pełny full полное	30	ocynk galvanized гальваника	stal steel сталь
PK-0H45300GX1	300					
PK-0H45350GX1	350					
PK-0H45400GX1	400					
PK-0H45450GX1	450					
PK-0H45500GX1	500					
PK-0H45550GX1	550					
PK-0H45600GX1	600					
PK-0H45650GX1	650					
PK-0H45700GX1	700					



Prowadnica kulkowa VERSALITE PLUS ze spowalniaczem H35
 Ball bearing slide VERSALITE PLUS with soft closing H35
 Шариковая направляющая VERSALITE PLUS с доводчиком H35



	 L mm	 AV mm		 kg		
PK-L-H35-300	300*	52	pełny full полное	20	ocynk galvanized гальваника	stal steel сталь
PK-L-H35-350	350*	35				
PK-L-H35-400	400*	20				
PK-L-H35-450	450	4				
PK-L-H35-500	500					
PK-L-H35-550	550					

* Brak pełnego wysuwu / Not full extension / Неполное выдвигание





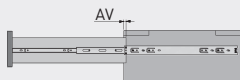
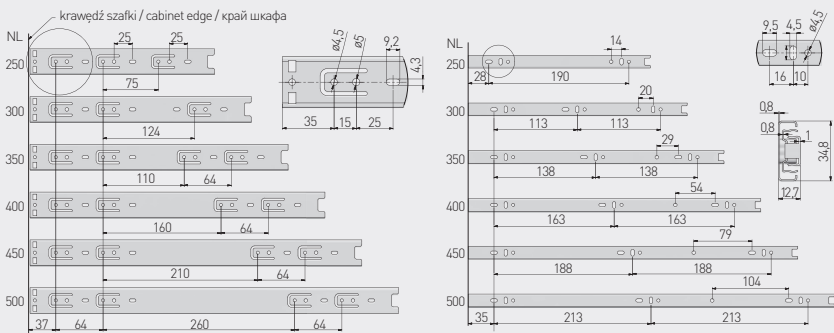



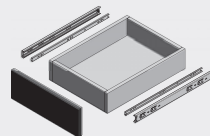

Prowadnica kulkowa H35
Ball bearing slide H35
Шариковая направляющая H35



NL = długość nominalna prowadnicy
nominal slide length
номинальная длина направляющей
AV = strata wysuwu
extension loss
потеря на выдвигании









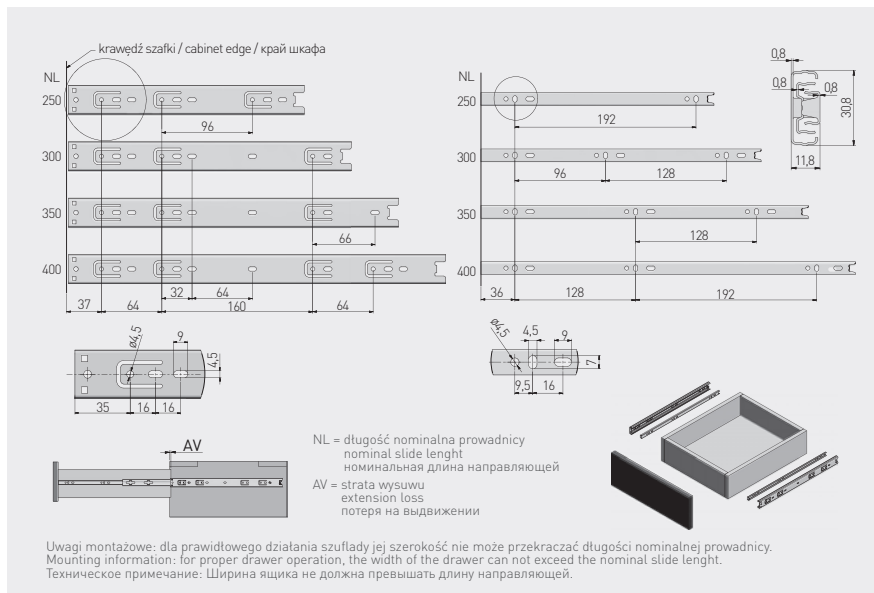

Uwagi montażowe: dla prawidłowego działania szuflady jej szerokość nie może przekraczać długości nominalnej prowadnicy.
Mounting information: for proper drawer operation, the width of the drawer can not exceed the nominal slide length.
Техническое примечание: Ширина ящика не должна превышать длину направляющей.

								
PK-0H35-2500	250	4	pełny full полное	25	ocynk galvanized гальваника	stal steel сталь	30	
PK-0-H35-3000	300						20	
PK-0-H35-3500	350							
PK-0-H35-4000	400							
PK-0-H35-4500	450							
PK-0-H35-5000	500							



Prowadnica kulkowa H30
 Ball bearing slide H30
 Шариковая направляющая H30







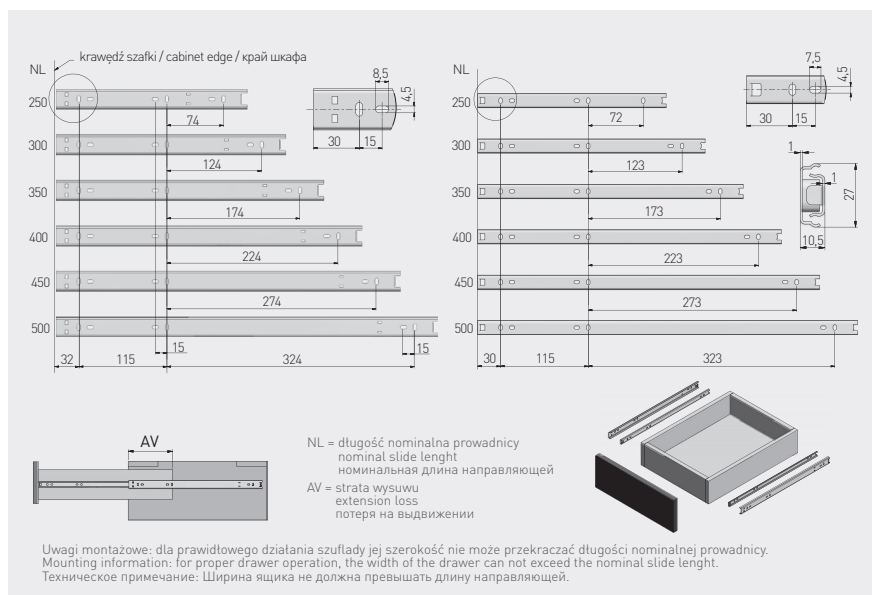

		 L mm	 AV mm		 kg		
PK-0H30-2500		250	-	pełny full полное	15	ocynk galvanized гальваника	stal steel сталь
PK-0H30-3000		300					
PK-0H30-3500		350					
PK-0H30-4000		400					



Prowadnica kulkowa H27
 Ball bearing slide H27
 Шариковая направляющая H27



	 L mm	 AV mm		 kg		
PK-0H27-3000	300	109	niepełny partial неполное	15		stal steel сталь
PK-0H27-3500	350	124				
PK-0H27-4000	400	134				
PK-0H27-4500	450	149				
PK-0H27-5000	500	184				



Prowadnica kulkowa do półki pod klawiaturę H27
 Ball bearing slide for keyboard H27
 Шариковая направляющая для полки под клавиатуру H27

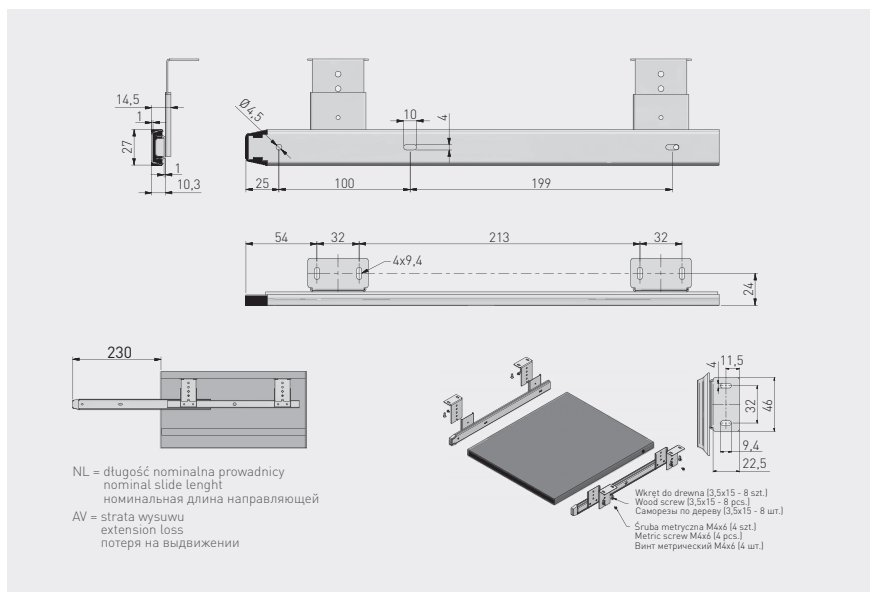

					
PK-0-000-027	360 mm	niepełny partial неполное	10 kg	ocynk galvanized гальваника	stal steel сталь



Prowadnica kulkowa H17
Ball bearing slide H17
Шариковая направляющая H17

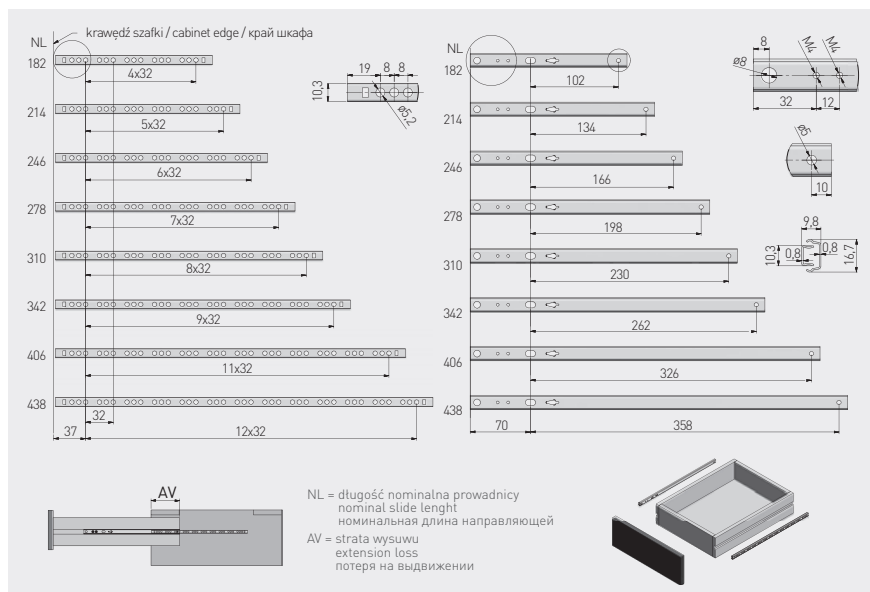

Model	L (mm)	AV (mm)	Configuration	Material	Finish	Material	Weight
PK-0H17182XP	182	62	niepełny partial неполное	10	ocynk galvanized гальваника	stal steel сталь	100
PK-0H17214XP	214	77					
PK-0H17246XP	246						
PK-0H17278XP	278						
PK-0H17310XP	310	100					
PK-0H17342XP	342						
PK-0H17406XP	406						
PK-0H17438XP	438	50					



Prowadnica Metalbox MP
Slide Metalbox MP
Направляющая Metalbox MP





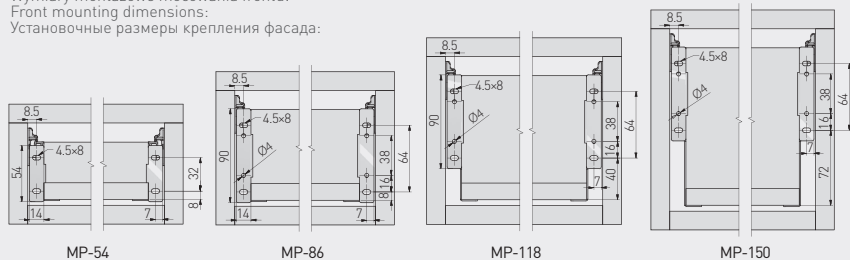



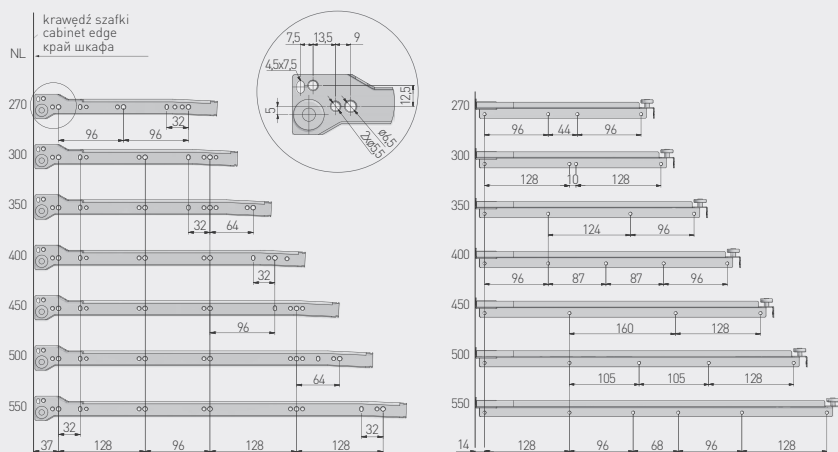

Wymiary montażowe mocowania frontu:
Front mounting dimensions:
Установочные размеры крепления фасада:









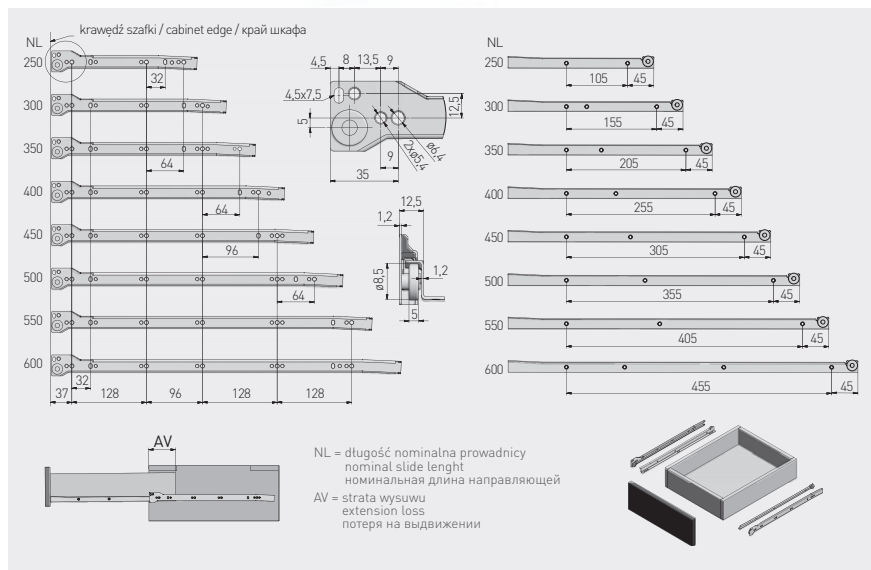

Rozstaw otworów montażowych:
Mounting dimensions:
Монтажные отверстия:



									
MP-054350-10	54	350	88	niepełny partial неполное	25	lakier lacquer лак	biały white белый	stal steel сталь	
MP-054400-10		400	98						
MP-054450-10		450							
MP-054500-10		500							
MP-054450-80		450							
MP-054500-80		500							
MP-086270-10	86	270	88						
MP-086300-10		300							
MP-086350-10		350							
MP-086400-10		400	98						
MP-086450-10		450							
MP-086500-10		500							
MP-086550-10		550	118						
MP-086270-80		270	88						
MP-086300-80		300							
MP-086350-80		350							
MP-086400-80		400	98						
MP-086450-80		450							
MP-086500-80		500							
MP-086550-80		550	118						
MP-118350-10		118	350	88					
MP-118400-10			400	98					
MP-118450-10			450						
MP-118500-10			500						
MP-150270-10	150	270	88						
MP-150300-10		300							
MP-150350-10		350							
MP-150400-10		400	98						
MP-150450-10		450							
MP-150500-10		500							
MP-150550-10		550	118						
MP-150270-80		270	88						
MP-150300-80		300							
MP-150350-80		350							
MP-150400-80		400	98						
MP-150450-80		450							
MP-150500-80		500							
MP-150550-80		550	118						

Prowadnica rolkowa SP
Euro roller slide
Роликовая направляющая SP



		 L mm	 AV mm	 kg			
PR-SP-250-10		250	85	25	biały white белый	lakier lacquer лак	stal steel сталь
PR-SP-300-10		300					
PR-SP-350-10		350					
PR-SP-400-10		400	95				
PR-SP-450-10		450					
PR-SP-500-10		500					
PR-SP-550-10		550	115				
PR-SP-600-10		600					



Prowadnica rolkowa 0B
Euro roller slide 0B
Роликовая направляющая 0B

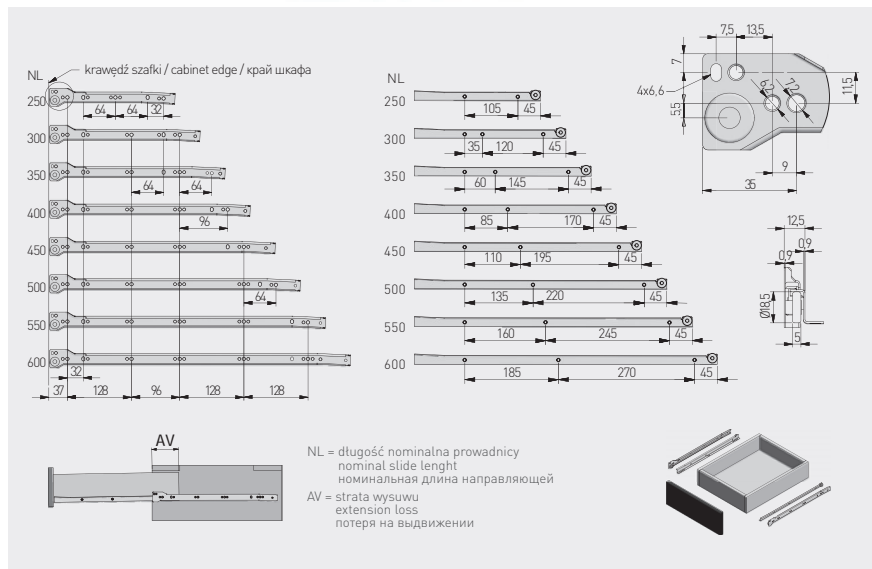



Folder	L (mm)	AV (mm)	Weight (kg)	Color	Material	Folder	L (mm)	AV (mm)	Weight (kg)	Color	Material
	250	100	20	biały / white / белый	stal / steel		250	100	20	brązowy / brown / коричневый	stal / steel
	300						300				
	350						350				
	400						400				
	450						450				
	500	110					500	110			
	550	115					550	115			
	600	125					600	125			

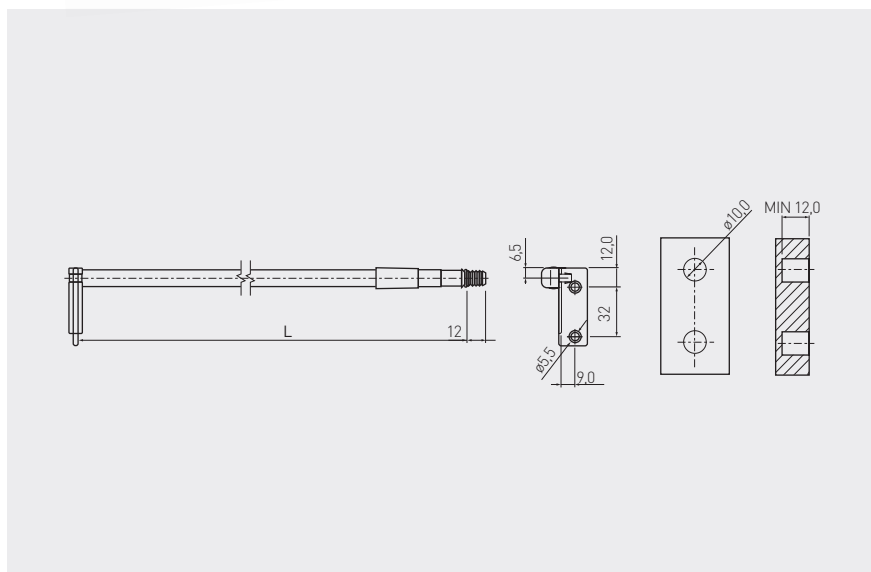

Reling z uchwytem ścianki tylnej lewy / prawy
 Rail with back panel connector left / right
 Релинг с ручкой задней стенки левый / правый



	 L mm	
RS-SZ-400-10	393 / 404	biały / white / белый
RS-SZ-450-10	443 / 454	biały / white / белый
RS-SZ-450-80	443 / 454	srebrny / silver / серебро
RS-SZ-500-10	493 / 504	biały / white / белый
RS-SZ-500-80	493 / 504	srebrny / silver / серебро

L - długość rzeczywista relingu mieszcząca się w przedziale (Lmin; Lmax) / actual length / фактическая длина релинга в пределах (Lмин; Lмакс)



Spowalniacz do prowadnic rolkowych oraz szuflad typu Metalbox 350 - 550 mm
 Soft closing device for euro roller slide and Metalbox 350 - 550 mm
 Доводчик для роликовых направляющих и Металбоксов 350 - 550 мм



			
AM-MBSOFT-P2	25	szary gray серый	tworzywo plastic пластмасса

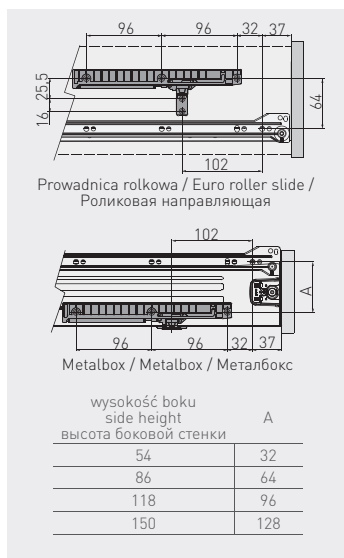

Rolka stabilizująca
 Drawer stabilizer
 Стабилизирующий механизм

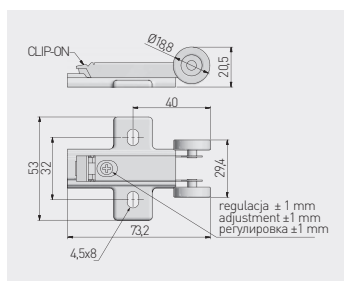

Do szuflad skrzyniowych wyposażonych w prowadnice push to open
 For drawers with push to open
 Для ящиков с направляющими push to open

		
PB-D-P20STAB	nikiel / nickel / никель	stal / steel / сталь



Modern Box Square

Skład zestawu
Set
Комплектация

MOCOWANIE ŚCIANKI TYLNEJ

niskie / średnie / wysokie
szare / białe

BACK PANEL CONNECTOR

low / medium / high
gray / white

КРЕПЛЕНИЕ ЗАДНЕЙ СТЕНКИ

низкий / средний / высокий вариант
серый / белый

RELING WZDŁUŻNY

szary / biały
L = 250 - 550 mm

LONGITUDINAL RAIL

gray / white
L = 250 - 550 mm

ПРОДОЛЬНЫЙ РЕЙЛИНГ

серый / белый
L = 250 - 550 мм

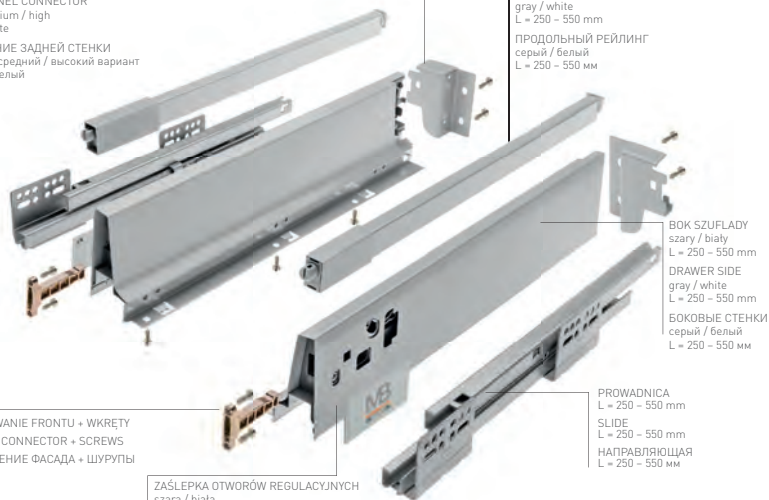

BOK SZUFLADY

szary / biały
L = 250 - 550 mm

DRAWER SIDE

gray / white
L = 250 - 550 mm

БОКОВЫЕ СТЕНКИ

серый / белый
L = 250 - 550 мм

MOCOWANIE FRONTU + WKRETY

FRONT CONNECTOR + SCREWS

КРЕПЛЕНИЕ ФАСАДА + ШРУБЫ

ZASŁEPKA OTWORÓW REGULACYJNYCH

szara / biała

COVER CAP

gray / white

ЗАГЛУШКИ ДЛЯ ОТВЕРСТИЙ

серый / белый

PROWADNICA

L = 250 - 550 mm

SLIDE

L = 250 - 550 mm

НАПРАВЛЯЮЩАЯ

L = 250 - 550 мм



Modern Box Square

Komplet szuflady niskiej A
Low drawer set A
Низкий ящик A

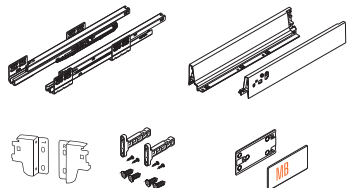





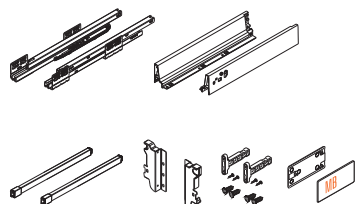

		 L mm	 kg			
PB-KW-KPL300A	300	40	szary gray серый	lakier lacquer лак	stal steel сталь	
PB-KW-KPL350A	350					
PB-KW-KPL400A	400					
PB-KW-KPL450A	450					
PB-KW-KPL500A	500					
PB-KW-KPL550A	550	50	biały white белый	lakier lacquer лак	stal steel сталь	
PB-KW-KPL350A1-50	350					
PB-KW-KPL400A1-50	400					
PB-KW-KPL450A1-50	450					
PB-KW-KPL500A1-50	500					
PB-KW-KPL550A1-50	550					

Modern Box Square

Komplet szuflady średniej B
Medium drawer set B
Средний ящик B



		 L mm	 kg			
PB-KW-KPL250B	250	40	szary gray серый	lakier lacquer лак	stal steel сталь	
PB-KW-KPL350B	350					
PB-KW-KPL400B	400					
PB-KW-KPL450B	450					
PB-KW-KPL500B	500					
PB-KW-KPL550B	550	50	biały white белый	lakier lacquer лак	stal steel сталь	
PB-KW-KPL350B-50	350					
PB-KW-KPL400B-50	400					
PB-KW-KPL550B-50	550					
PB-KW-KPL250B1-50	250					
PB-KW-KPL350B1-50	350					
PB-KW-KPL400B1-50	400					
PB-KW-KPL450B1-50	450					
PB-KW-KPL500B1-50	500					

Modern Box Square

Komplet szuflady wysokiej C
High drawer set C
Высокий ящик C

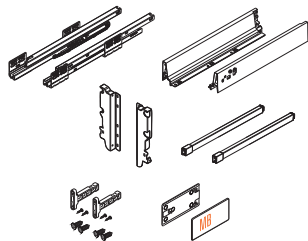

	L mm	kg			
PB-KW-KPL250C	250	40	szary gray серый	lakier lacquer лак	stal steel сталь
PB-KW-KPL300C	300				
PB-KW-KPL350C	350				
PB-KW-KPL400C	400				
PB-KW-KPL450C	450				
PB-KW-KPL500C	500				
PB-KW-KPL550C	550	50	biały white белый	lakier lacquer лак	stal steel сталь
PB-KW-KPL350C1-50	350				
PB-KW-KPL400C1-50	400				
PB-KW-KPL450C1-50	450				
PB-KW-KPL500C1-50	500				
PB-KW-KPL550C1-50	550				

Reiling wzdużny Longitudinal drawer rail Продольный рейлин

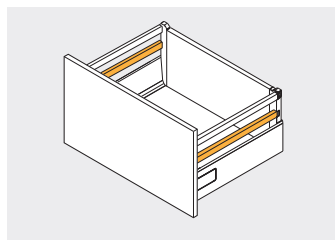





	L mm			
PB-D-RELKW350	350	szary gray серый	lakier lacquer лак	stal steel сталь
PB-D-RELKW400	400			
PB-D-RELKW450	450			
PB-D-RELKW500	500			
PB-D-RELKW550	550			

	L mm			
PB-D-RELKW350-10	350	biały white белый	lakier lacquer лак	stal steel сталь
PB-D-RELKW400-10	400			
PB-D-RELKW450-10	450			
PB-D-RELKW500-10	500			
PB-D-RELKW550-10	550			

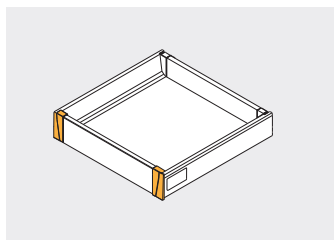

Złączka frontu wewnętrzznego, niska
 Inner front connector, low
 Соединитель передней панели, низкий





			
PB-D-WEWMOCA-KW	szuflada niska A low drawer A низкий ящик A	szary / gray / серый	tworzywo plastic пластмасса
PB-D-WEWMOCA-KW-10		biały / white / белый	

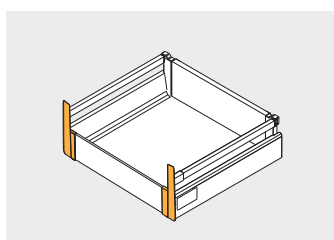

Złączka frontu wewnętrzznego, średnia
 Inner front connector, medium
 Соединитель передней панели, средний



			
PB-D-WEWMOCB-KW	szuflada średnia B medium drawer B средний ящик B	szary / gray / серый	tworzywo plastic пластмасса
PB-D-WEWMOCB-KW-10		biały / white / белый	



Złączka frontu wewnętrznego, wysoka
 Inner front connector, high
 Соединитель передней панели, высокий

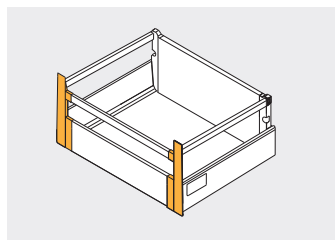

			
PB-D-WEWMOCC-KW	szuflada wysoka C high drawer C высокий ящик C	szary / gray / серый	tworzywo plastic пластмасса
PB-D-WEWMOCC-KW-10		biały / white / белый	



Panel przedni frontu wewnętrznego
 Front panel
 Передняя панель внутреннего ящика

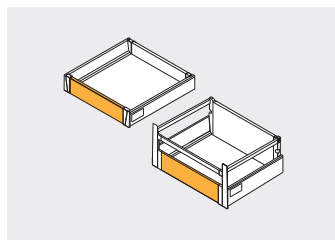

	 mm		
PB-D-PANELWEW	1100	szary / gray / серый	aluminium aluminium алюминий
PB-D-PANELWEW-10		biały / white / белый	



Reling poprzeczny
Transverse rail
Поперечный рейлинг

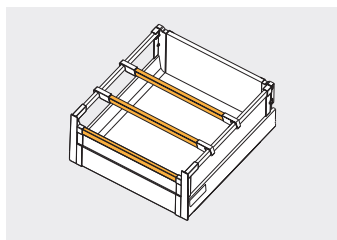





			
PB-RP-KW1100	1100	szary / gray / серый	stal steel сталь
PB-RP-KW1100-10		biały / white / белый	

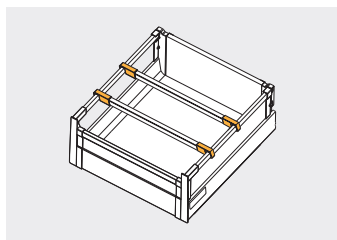

Łącznik relingu poprzecznego
Transverse rail connector
Соединитель поперечного рейлинга



			
PB-D-ZR-KW-00	1 kpl. = 2 szt. 1 set = 2 pcs 1 комп. = 2 шт.	szary / gray / серый	tworzywo plastic пластмасса
PB-D-ZR-KW-10		biały / white / белый	



Listwa poprzeczna
Transverse bar
Поперечная планка

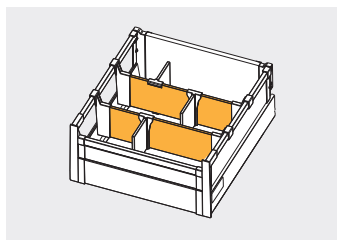





	 mm		
PB-D-LIS1100-KW	1100	szary / gray / серый	aluminium aluminium алюминий
PB-D-LIS1100-KW-10		biały / white / белый	

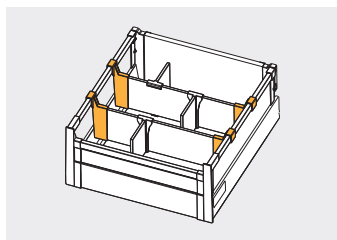

Złączka do listwy poprzecznej
Transverse bar connector
Соединитель поперечной планки



			
PB-D-CONREL-KW	1 kpl. = 2 szt. 1 set = 2 pcs 1 комп. = 2 шт.	szary / gray / серый	tworzywo plastic пластмасса
PB-D-CONREL-KW-10		biały / white / белый	



Przegroda do listwy poprzecznej
 Transverse bar divider
 Перегородка для поперечной планки

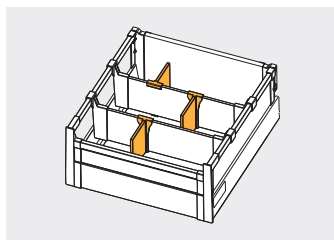

PB-D-PRZEGLP-KW	1 szt. 1 pc	szary / gray / серый	tworzywo plastic пластмасса
PB-D-PRZEGLP-KW-10	1 шт.	biały / white / белый	



Mocowanie relingu do podwyższonej ścianki tylnej
 Back panel connector for rails, additional
 Соединитель задней стенки для рейлингов, дополнительная

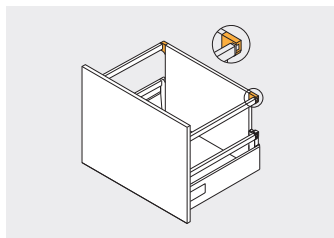



PB-D-D2R0-01	1 kpl. = 2 szt. 1 set = 2 pcs 1 комп. = 2 шт.	biały / white / белый	tworzywo plastic пластмасса
--------------	---	-----------------------	-----------------------------------

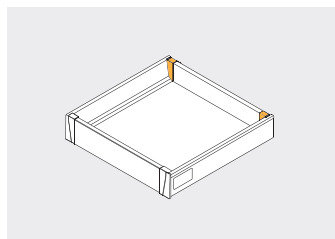

Złączka ścianki tylnej, niska
 Back panel connector, low
 Держатель задней стенки, низкий







			
PB-D-N2R0-00	1 kpl. = L+P 1 set = L+R	szary / gray / серый	stal steel
PB-D-N2R0-01	1 комп. = Л+П	biały / white / белый	сталь

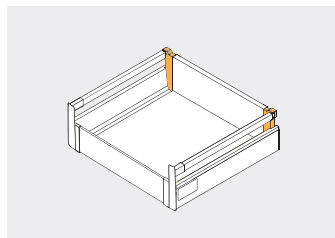

Złączka ścianki tylnej, średnia
 Back panel connector, medium
 Держатель задней стенки, средний



			
PB-D-S2R0-00	1 kpl. = L+P 1 set = L+R	szary / gray / серый	stal steel
PB-D-S2R0-01	1 комп. = Л+П	biały / white / белый	сталь



Złączka ścianki tylnej, wysoka
 Back panel connector, high
 Держатель задней стенки, высокий

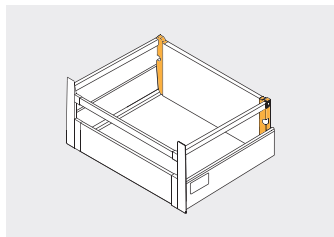

PB-D-W2R0-00	1 kpl. = L+P 1 set = L+R	szary / gray / серый	stal steel
PB-D-W2R0-01	1 комп. = Л+П	biały / white / белый	stal steel



Mocowanie do relingów
 Rails mounting
 Держатель рейлинга



PB-D-MHG04-KW	1 szt. 1 pc 1 шт.	szary gray серый	tworzywo plastic пластмасса
---------------	-------------------------	------------------------	-----------------------------------



Matryca do relingów
 Marking gauge for rails
 Матрица для рейлингов



			
PB-D-MATRYCA	1 kpl. = 1 szt. 1 set = 1 pc 1 комп. = 1 шт.	szary gray серый	tworzywo plastic пластмасса



Znacznik do frontów
 Marking gauge for drawer front
 Маркер фасада



			
PB-D-ZNACZ-0	1 kpl. = 2 szt. 1 set = 2 pcs 1 комп. = 2 шт.	szary gray серый	ZnAl



Modern Box



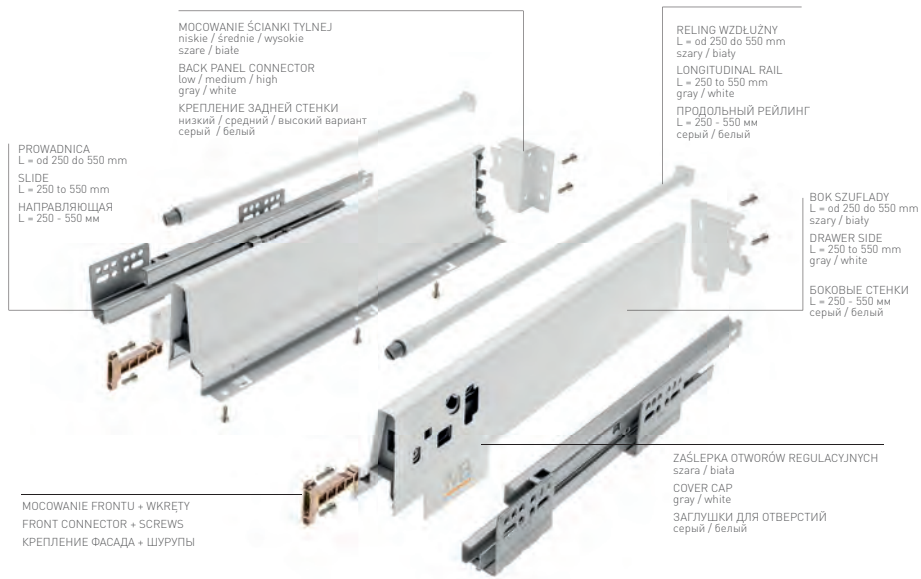



Skład zestawu
Set
Комплектация

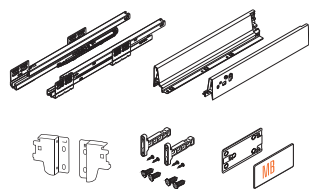

Modern Box

Komplet szuflady niskiej A
Low drawer set A
Низкий ящик A



		 L mm		 kg			
PB-D-KPL250A	250	soft close	40		szary gray серый	lakier lacquer лак	stal steel сталь
PB-D-KPL300A	300						
PB-D-KPL350A	350						
PB-D-KPL400A	400						
PB-D-KPL450A	450						
PB-D-KPL500A	500						
PB-D-KPL550A	550						
PB-D-KPL250A1	250						
PB-D-KPL300A1	300						
PB-D-KPL350A1	350						
PB-D-KPL400A1	400						
PB-D-KPL450A1	450						
PB-D-KPL500A1	500						
PB-D-KPL550A1	550						
PB-D-P20250A	250	push to open			szary gray серый		
PB-D-P20300A	300						
PB-D-P20350A	350						
PB-D-P20400A	400						
PB-D-P20450A	450						
PB-D-P20500A	500						
PB-D-P20550A	550						



Modern Box

Komplet szuflady średniej B
Medium drawer set B
Средний ящик B



PB-D-KPL300B	300	soft close	40	szary gray серый	lakier lacquer лак	stal steel сталь
PB-D-KPL350B	350					
PB-D-KPL400B	400					
PB-D-KPL450B	450					
PB-D-KPL500B	500					
PB-D-KPL550B	550					

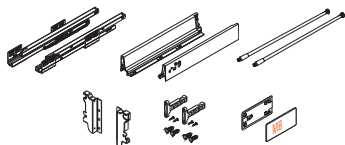

Modern Box

Komplet szuflady wysokiej C
High drawer set C
Высокий ящик C





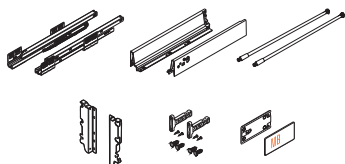



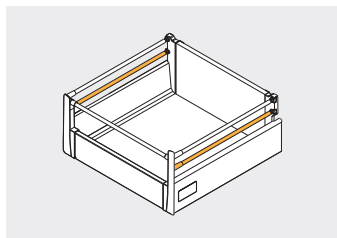

PB-D-KPL250C	250	soft close	40	szary gray серый	lakier lacquer лак	stal steel сталь		
PB-D-KPL300C	300							
PB-D-KPL350C	350							
PB-D-KPL400C	400							
PB-D-KPL450C	450							
PB-D-KPL500C	500							
PB-D-KPL550C	550							
PB-D-KPL250C1	250			push to open	szary gray серый	biały white белый	lakier lacquer лак	stal steel сталь
PB-D-KPL300C1	300							
PB-D-KPL350C1	350							
PB-D-KPL400C1	400							
PB-D-KPL450C1	450							
PB-D-KPL500C1	500							
PB-D-KPL550C1	550							
PB-D-P20250C	250	push to open	szary gray серый	szary gray серый	lakier lacquer лак	stal steel сталь		
PB-D-P20300C	300							
PB-D-P20350C	350							
PB-D-P20400C	400							
PB-D-P20450C	450							
PB-D-P20500C	500							
PB-D-P20550C	550							



Reлинг wzdużny
Longitudinal rail
Продольный рейлинг







		 L mm		
PB-D-REL2500		250	szary gray серый	stal steel сталь
PB-D-REL3000		300		
PB-D-REL3500		350		
PB-D-REL4000		400		
PB-D-REL4500		450		
PB-D-REL5000		500		
PB-D-REL5500		550		

		 L mm		
PB-D-REL450-10		450	biały white белый	stal steel сталь
PB-D-REL500-10		500		
PB-D-REL550-10		550		

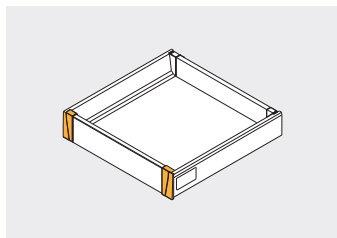

Złączka frontu wewnętrznej, niska
Inner front connector, low
Соединитель передней панели, низкий







				
PB-D-WEWMOCA		szuflada niska A low drawer A низкий ящик A	szary / gray / серый	tworzywo plastic пластмасса
PB-D-WEWMOCA1			biały / white / белый	

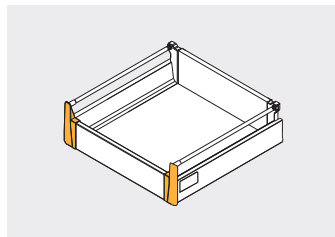

Złączka frontu wewnętrznego, średnia
 Inner drawer connector, medium
 Соединитель передней панели, средний







			
PB-D-WEWMOCB	szuflada średnia B medium drawer B средний ящик B	szary / gray / серый	tworzywo plastic пластмасса
PB-D-WEWMOCB1		biały / white / белый	

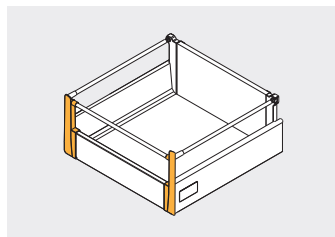

Złączka frontu wewnętrznego, wysoka, do 1 kompletu relingów
 Inner drawer connector high, for 1 set of rails
 Соединитель передней панели, высокий, для 1 комплекта рейлингов







			
PB-D-WEWSZKLC	szuflada wysoka C, 1 reling high drawer C, 1 rail высокий ящик C, рейлинг -1 шт.	szary / gray / серый	tworzywo plastic пластмасса
PB-D-WEWSZKLC-10		biały / white / белый	

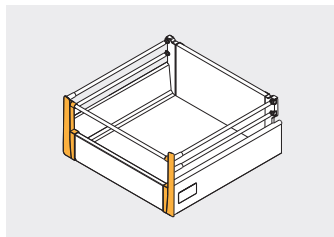

Złączka frontu wewnętrznego, wysoka, do 2 kompletów relingów
 Inner drawer front connector, high, for 2 sets of rails
 Соединитель передней панели, высокий, для 2 комплектов релингов







			
PB-D-WEWMOCC	szuflada wysoka C, 2 relingi high drawer C, 2 rails	szary / gray / серый	tworzywo plastic
PB-D-WEWMOCC1	высокий ящик C, рейлинг -2 шт.	biały / white / белый	пластмасса

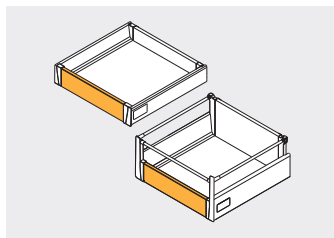

Panel przedni frontu wewnętrznego
 Front panel
 Передняя панель







			
PB-D-PANELWEW	1100	szary / gray / серый	aluminium
PB-D-PANELWEW-10		biały / white / белый	aluminium алюминий

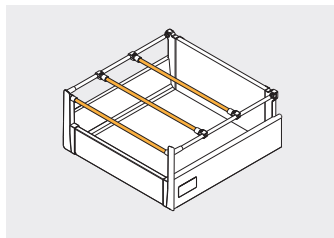

Reling poprzeczny
Transverse rail
Поперечный рейлинг





			
PB-D-RP-1100	1100	szary / gray / серый	stal
PB-D-RP-1100-10		biały / white / белый	steel сталь

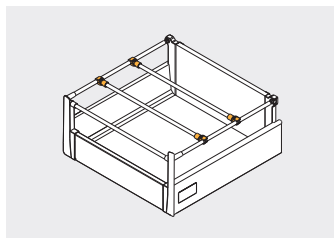

Łącznik relingu poprzecznego
Transverse rail connector
Соединитель поперечного рейлинга



			
PB-D-ZR-00-0	1 kpl. = 2 szt. 1 set = 2 pcs 1 комп. = 2 шт.	szary / gray / серый	tworzywo plastic пластмасса
PB-D-ZR-00-10		biały / white / белый	



Uchwyt do szuflady wewnętrznej
 Inner drawer handle
 Ручка для внутреннего ящика

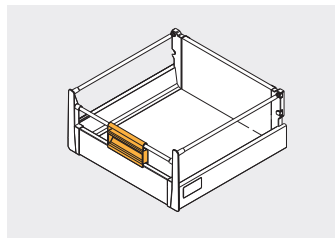

PB-D-UCHWEW	szary / gray / серый	tworzywo plastic пластмасса
PB-D-UCHWEW-10	biały / white / белый	



Łącznik krzyżowy do relingu
 Cross rail connector
 Крестообразный соединитель рейлингов

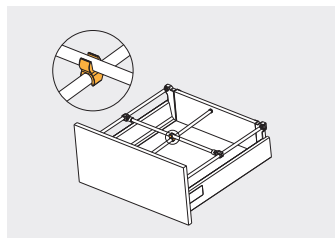
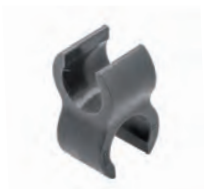

PB-D-LR-00-0	szary / gray / серый	tworzywo plastic пластмасса
PB-D-LR-00-10	biały / white / белый	



Zaślepka do relingu poprzecznego
End cap for transverse rail
Заглушка для поперечного рейлинга

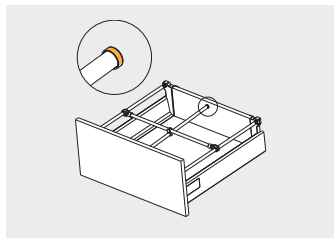





		
PB-D-RELCOV	szary / gray / серый	tworzywo plastic пластмасса
PB-D-RELCOV-10	biały / white / белый	

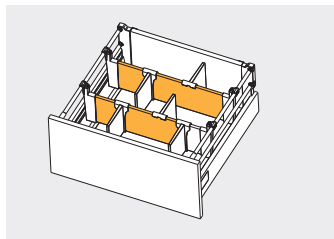

Listwa poprzeczna
Transverse bar
Поперечная планка



			
PB-D-LIS1100	1100	szary / gray / серый	aluminium алюминий
PB-D-LIS1100-10		biały / white / белый	



Złączka listwy poprzecznej do relingu
 Connector for transverse rail and bar
 Соединитель поперечных планок и рейлингов

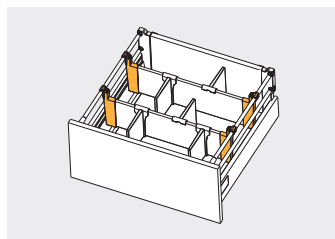

PB-D-CONREL	1 kpl. = 2 szt. 1 set = 2 pcs	szary / gray / серый	tworzywo plastic
PB-D-CONREL-10	1 комп. = 2 шт.	biały / white / белый	пластмасса



Złączka listwy poprzecznej do boku perforowanego
 Transverse bar connector for perforated sides
 Соединитель поперечных планок и перфорированных боковин

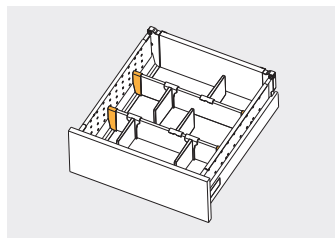

PB-D-CONBXSID	1 kpl. = 2 szt. 1 set = 2 pcs	szary / gray / серый	tworzywo plastic
PB-D-CONBXSIDE-10	1 комп. = 2 шт.	biały / white / белый	пластмасса



Przegroda listwy poprzecznej
 Transverse bar divider
 Перегородка для поперечной планки

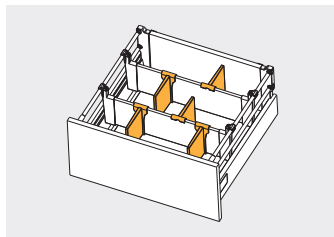

PB-D-PRZEGLP	szary / gray / серый	tworzywo plastic пластмасса
PB-D-PRZEGLP-10	biały / white / белый	



Bok perforowany do szuflady średniej
 Perforated side for medium drawer
 Перфорированная боковина, низкая

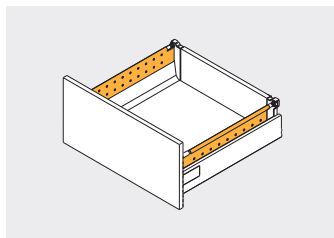





PB-D-BXSIDE45B	450	szary / gray / серый	stal steel сталь
PB-D-BXSIDE45B-10		biały / white / белый	
PB-D-BXSIDE50B	500	szary / gray / серый	
PB-D-BXSIDE50B-10		biały / white / белый	

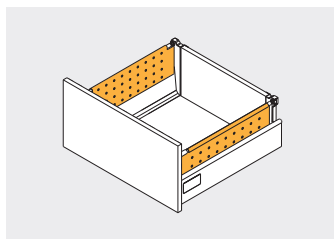
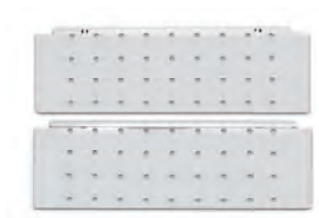

Bok perforowany do szuflady wysokiej
 Perforated side for high drawer
 Перфорированная боковина, высокая







	 L mm		
PB-D-BXSIDE45C	450	szary / gray / серый	stal steel сталь
PB-D-BXSIDE45C-10		biały / white / белый	
PB-D-BXSIDE50C	500	szary / gray / серый	
PB-D-BXSIDE50C-10		biały / white / белый	

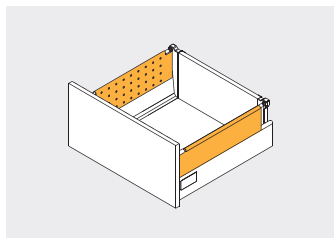
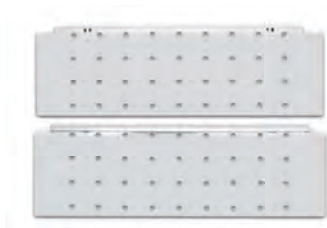

Podwójny bok perforowany do szuflady wysokiej
 Double perforated side for high drawer
 Боковая стенка для высокого ящика, двойная, перфорированная







	 L mm		
PB-D-DBOX450C	450	szary gray серый	stal steel сталь
PB-D-DBOX500C	500		

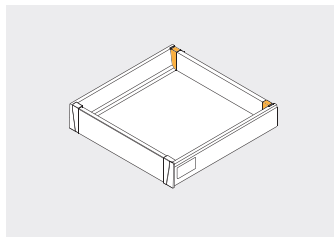

Złączka ścianki tylnej, niska
 Back panel connector, low
 Соединитель задней стенки, низкий







			
PB-D-N2R0-00	1 kpl. = L+P 1 set = L+R	szary / gray / серый	stal steel
PB-D-N2R0-01	1 комп. = Л+П	biały / white / белый	сталь

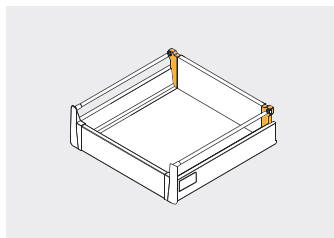

Złączka ścianki tylnej, średnia
 Back panel connector, medium
 Соединитель задней стенки, средний



			
PB-D-S2R0-00	1 kpl. = L+P 1 set = L+R	szary / gray / серый	stal steel
PB-D-S2R0-01	1 комп. = Л+П	biały / white / белый	сталь



Złączka ścianki tylnej, wysoka
 Back panel connector, high
 Соединитель задней стенки, высокий

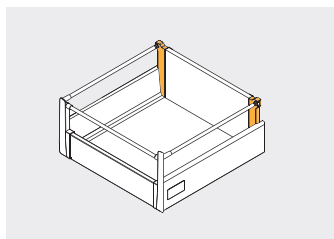

PB-D-W2R0-00	1 kpl. = L+P 1 set = L+R	szary / gray / серый	stal steel
PB-D-W2R0-01	1 комп. = Л+П	biały / white / белый	сталь



Mocowanie relingu do podwyższonej ścianki tylnej
 Back panel connector for rails, additional
 Соединитель задней стенки для рейлингов, дополнительная

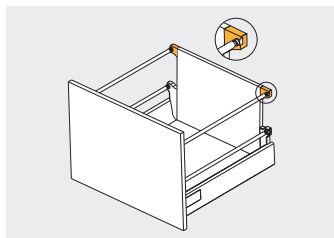





PB-D-D2R0-00	1 kpl. = 2 szt. 1 set = 2 pcs	szary / gray / серый	tworzywo plastic
PB-D-D2R0-01	1 комп. = 2 шт.	biały / white / белый	пластмасса



Matryca do relingów
Marking gauge for rails
Матрица для рейлингов







			
PB-D-MATRYCA	1 kpl. = 1 szt. 1 set = 1 pcs 1 комп. = 1 шт.	szary gray серый	tworzywo plastic пластмасса



Znacznik do frontów
Marking gauge for drawer front
Маркер фасада







			
PB-D-ZNACZ-0	1 kpl. = 2 szt. 1 set = 2 pcs 1 комп. = 2 шт.	szary gray серый	ZnAl



Mocowanie do relingów
Rail mounting
Держатель рейлинга



			
PB-D-MHG04	1 kpl. = 2 szt. 1 set = 2 pcs 1 комп. = 2 шт.	szary gray серый	tworzywo plastic пластмасса



Rolka stabilizująca do szuflad push to open
 Drawer stabilizer for push to open drawers
 Стабилизирующий механизм для ящиков

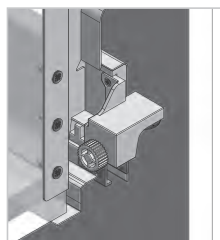

PB-D-MBSTAB-00	1 kpl. = L+P 1 set = L+R 1 комп. = Л+П	szary gray серый	tworzywo plastic пластмасса



Modern Box

Komplet szuflady piekarnikowej niskiej
 Under oven drawer set – low
 Ящик под духовку, низкий



PB-D-KPL68-450-80	450	40	szary gray серый	lakier lacquer лак	stal steel сталь
PB-D-KPL68-500-80	500				
PB-D-KPL68-450-10	450		biały white белый		
PB-D-KPL68-500-10	500				

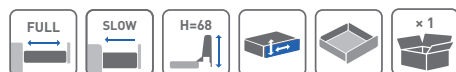
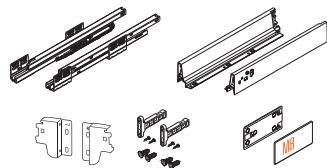

Modern Box

Komplet szuflady narożnej niskiej
Corner drawer set – low
Угловой ящик, низкий



PB-D-COR600A	600	40	szary gray серый	lakier lacquer лак	stal steel сталь
PB-D-COR650A	650				

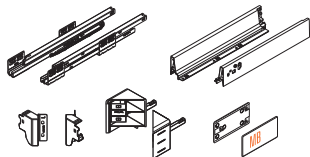

Modern Box

Komplet szuflady narożnej wysokiej
Corner drawer set – high
Угловой ящик, высокий



PB-D-COR600C	600	40	szary gray серый	lakier lacquer лак	stal steel сталь
PB-D-COR650C	650				

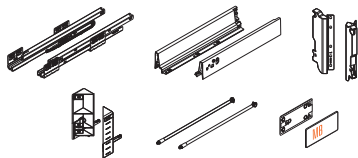

Modern Box

Komplet szuflady zlewozmywakowej niskiej
Under sink drawer – set
Ящик под мойку



PB-D-ZLE-450	450	40	szary gray серый	lakier lacquer лак	stal steel сталь
PB-D-ZLE-500	500				

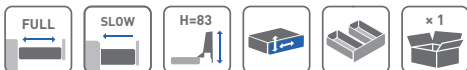
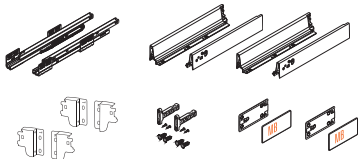

Modern Box

Komplet szuflady zlewozmywakowej U, niskiej
Under sink drawer U, low – set
Ящик под мойку U, низкий – компоненты



PB-D-ULE-500	500	40	szary gray серый	lakier lacquer лак	stal steel сталь
--------------	-----	----	------------------------	--------------------------	------------------------

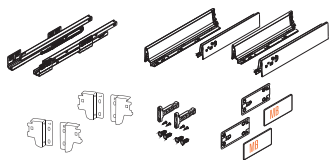

AXIS

Skład zestawu
Set
Комплектация

BOX SZUFLADY
szary / biały
L = 450 - 500 mm

DRAWER SIDE
gray / white
L = 450 - 500 mm

БОКОВИНЫ
цвет: серый / белый
L = 450 - 500 mm

MOCOWANIE ŚCIANKI TYLNEJ
niskie / średnie / wysokie
szare / białe

BACK PANEL CONNECTOR
low / medium / high
gray / white

КРЕПЛЕНИЕ ЗАДНЕЙ СТЕНКИ
низкое / среднее / высокое
серый / белый

ultracienki płaszcz boczny
ultra thin drawer sides
ультратонкие боковины

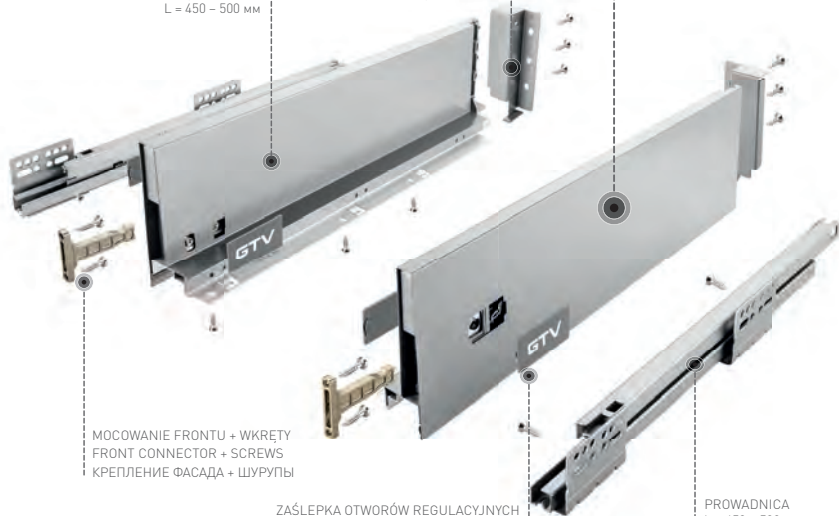

MOCOWANIE FRONTU + WKRETY
FRONT CONNECTOR + SCREWS
КРЕПЛЕНИЕ ФАСАДА + ШРУПЫ

ZĄSLEPKA OTWORÓW REGULACYJNYCH
szara / biała
COVER CAP
gray / white

ЗАГЛУШКИ ДЛЯ ОТВЕРСТИЙ
серый / белый

PROWADNICA
L = 450 - 500 mm

SLIDE
L = 450 - 500 mm







НАПРАВЛЯЮЩАЯ
L = 450 - 500 mm

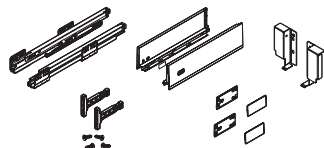

AXIS

Komplet szuflady niskiej A
Low drawer set A
Низкий ящик А



		 L mm	 kg			
PB-AXIS-KPL300A	300	40		szary gray серый	lakier lacquer лак	stal steel сталь
PB-AXIS-KPL350A	350					
PB-AXIS-KPL400A	400					
PB-AXIS-KPL450A	450					
PB-AXIS-KPL500A	500					
PB-AXIS-KPL550A	550					
PB-AXIS-KPL300A1	300					
PB-AXIS-KPL350A1	350					
PB-AXIS-KPL400A1	400					
PB-AXIS-KPL450A1	450					
PB-AXIS-KPL500A1	500					
PB-AXIS-KPL550A1	550					



AXIS

Komplet szuflady średniej B
Medium drawer set B
Средний ящик В

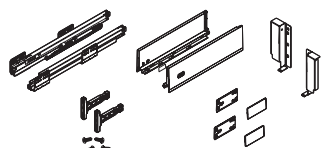

		 L mm	 kg			
PB-AXIS-KPL300B	300	40		szary gray серый	lakier lacquer лак	stal steel сталь
PB-AXIS-KPL350B	350					
PB-AXIS-KPL400B	400					
PB-AXIS-KPL450B	450					
PB-AXIS-KPL500B	500					
PB-AXIS-KPL550B	550					
PB-AXIS-KPL300B1	300					
PB-AXIS-KPL350B1	350					
PB-AXIS-KPL400B1	400					
PB-AXIS-KPL450B1	450					
PB-AXIS-KPL500B1	500					
PB-AXIS-KPL550B1	550					



AXIS

Komplet szuflady wysokiej C
High drawer set C
Высокий ящик C

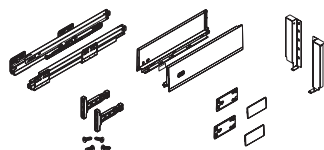

	L mm	kg			
PB-AXIS-KPL300C	300	40	szary gray серый	lakier lacquer лак	stal steel сталь
PB-AXIS-KPL350C	350				
PB-AXIS-KPL400C	400				
PB-AXIS-KPL450C	450				
PB-AXIS-KPL500C	500				
PB-AXIS-KPL550C	550		biały white белый		
PB-AXIS-KPL300C1	300				
PB-AXIS-KPL350C1	350				
PB-AXIS-KPL400C1	400				
PB-AXIS-KPL450C1	450				
PB-AXIS-KPL500C1	500				
PB-AXIS-KPL550C1	550				



Mocowanie relingu do podwyższonej ścianki tylnej

Back panel connector for rails, additional

Соединитель задней стенки для рейлингов, дополнительная

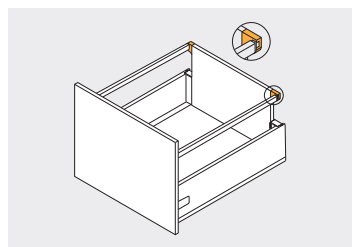

PB-AXIS-U2R0-00	1 kpl. = 2 szt. 1 set = 2 pcs	szary / gray / серый	tworzywo plastic пластмасса
PB-AXIS-U2R0-10	1 комп. = 2 шт.	biały / white / белый	



Reлинг wzdużny
Longitudinal rail
Продольный рейлинг

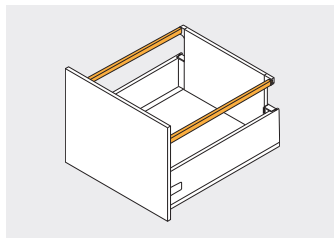





		 L mm			
PB-AXIS-RELKW300		300	szary / gray / серый	lakier lacquer лак	stal steel сталь
PB-AXIS-RELKW300-10			biały / white / белый		
PB-AXIS-RELKW350		350	szary / gray / серый		
PB-AXIS-RELKW350-10			biały / white / белый		
PB-AXIS-RELKW400		400	szary / gray / серый		
PB-AXIS-RELKW400-10			biały / white / белый		
PB-AXIS-RELKW450		450	szary / gray / серый		
PB-AXIS-RELKW450-10			biały / white / белый		
PB-AXIS-RELKW500		500	szary / gray / серый		
PB-AXIS-RELKW500-10			biały / white / белый		
PB-AXIS-RELKW550		550	szary / gray / серый		
PB-AXIS-RELKW550-10			biały / white / белый		

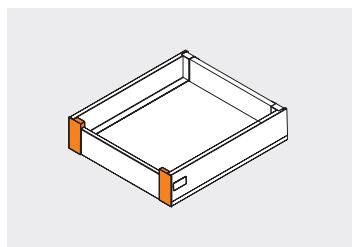

Złączka frontu wewnętrznego, niska
Inner front connector low
Соединитель передней панели, низкий



				
PB-AXIS-WEWMOCA		szuflada niska A low drawer A низкий ящик A	szary / gray / серый	tworzywo plastic пластмасса
PB-AXIS-WEWMOCA1			biały / white / белый	



Złączka frontu wewnętrznego, średnia
 Inner front connector medium
 Соединитель передней панели, средний

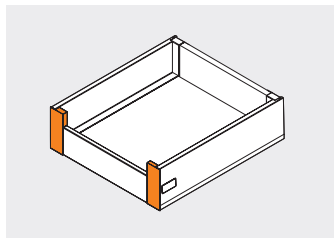

PB-AXIS-WEWMOCB	szuflada średnia B medium drawer B средний ящик B	szary / gray / серый	tworzywo plastic пластмасса
PB-AXIS-WEWMOCB1		biały / white / белый	



Złączka frontu wewnętrznego, wysoka
 Inner front connector high
 Соединитель передней панели, высокий

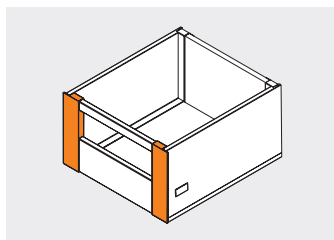

PB-AXIS-WEWMOCB	szuflada wysoka C high drawer C высокий ящик C	szary / gray / серый	tworzywo plastic пластмасса
PB-AXIS-WEWMOCB1		biały / white / белый	



Panel przedni frontu wewnętrznego
Front panel
Передняя панель

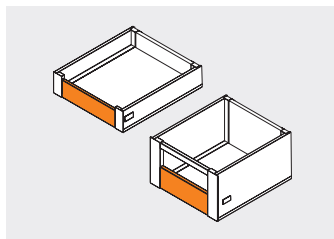

PB-AXIS-PANELWEW	1100	szary / gray / серый	aluminium aluminium алюминий
PB-AXIS-PANELWEW-10		biały / white / белый	



Reling poprzeczny
Transverse rail
Поперечный рейлинг

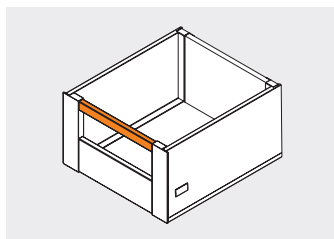

PB-AXIS-RP-1100	1054	szary / gray / серый	stal steel сталь
PB-AXIS-RP-1100-10		biały / white / белый	



LINOS BOX



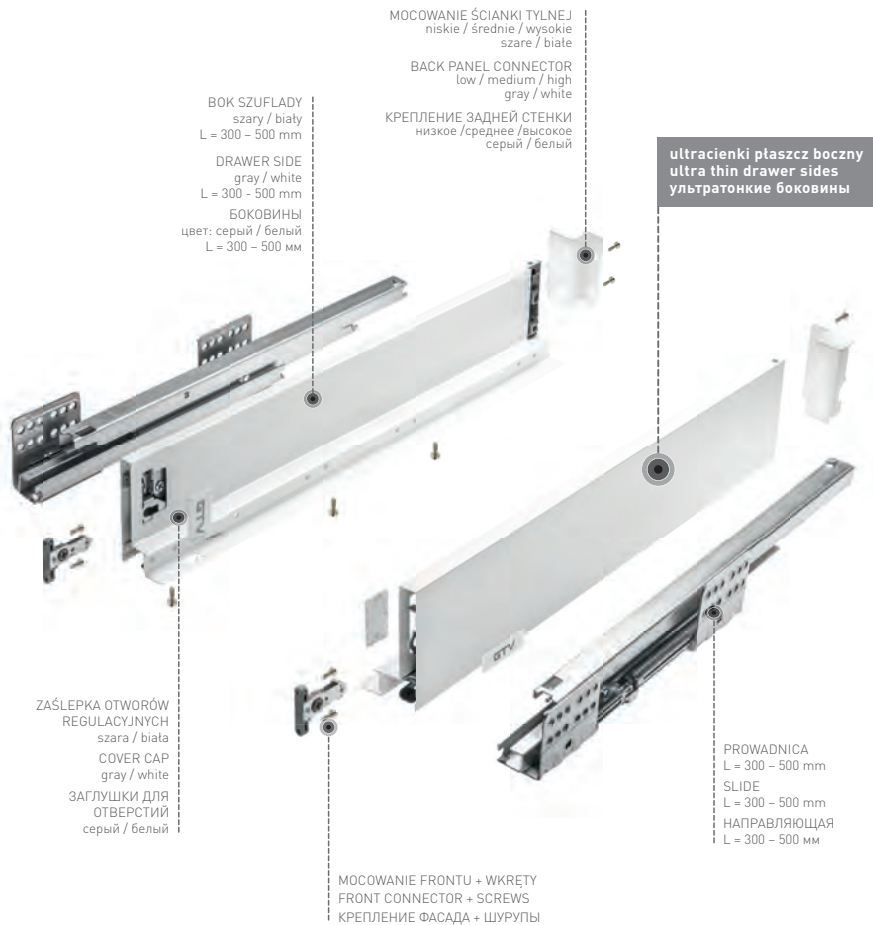



Skład zestawu
Set
Комплектация



LINOS BOX

Komplet szuflady niskiej A
 Low drawer set A
 Низкий ящик А









		 mm	 kg			
PB-LINOS-KPL300A		300	40	szary gray серый	lakier lacquer лак	stal steel сталь
PB-LINOS-KPL350A		350				
PB-LINOS-KPL400A		400				
PB-LINOS-KPL450A		450				
PB-LINOS-KPL500A		500				
PB-LINOS-KPL300A1		300		biały white белый		
PB-LINOS-KPL350A1		350				
PB-LINOS-KPL400A1		400				
PB-LINOS-KPL450A1		450				
PB-LINOS-KPL500A1		500				

LINOS BOX

Komplet szuflady średniej B
 Medium drawer set B
 Средний ящик В







		 mm	 kg			
PB-LINOS-KPL350B		350	40	szary gray серый	lakier lacquer лак	stal steel сталь
PB-LINOS-KPL400B		400				
PB-LINOS-KPL450B		450				
PB-LINOS-KPL500B		500				
PB-LINOS-KPL350B1		350				
PB-LINOS-KPL400B1		400				
PB-LINOS-KPL450B1		450				
PB-LINOS-KPL500B1		500				



LINOS BOX

Komplet szuflady wysokiej C
High drawer set C
Высокий ящик C







	 L mm	 kg			
PB-LINOS-KPL350C	350	40	szary gray серый	lakier lacquer лак	stal steel сталь
PB-LINOS-KPL400C	400				
PB-LINOS-KPL450C	450				
PB-LINOS-KPL500C	500				
PB-LINOS-KPL350C1	350		biały white белый		
PB-LINOS-KPL400C1	400				
PB-LINOS-KPL450C1	450				
PB-LINOS-KPL500C1	500				

**LINOS BOX**

Komplet szuflady bardzo wysokiej D
Very high drawer set D
Очень высокий ящик D





	 L mm	 kg			
PB-LINOS-KPL450D	450	40	szary gray серый	lakier lacquer лак	stal steel сталь
PB-LINOS-KPL500D	500				
PB-LINOS-KPL450D1	450		biały white белый		
PB-LINOS-KPL500D1	500				

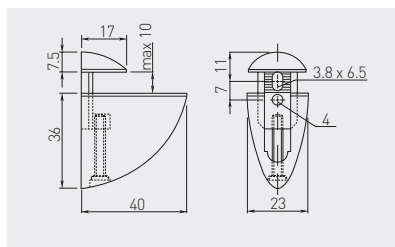

Podpórka PELIKAN mini Shelf support PELIKAN mini Полкодержатель PELIKAN мини



		
PP-XS0045-01	chrom / chrome / хром	ZnAl
PP-XS0045-02	satyna / satin / сатин	
PP-XS0045-05	aluminium / aluminium / алюминий	

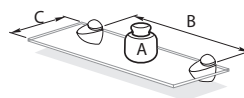

A - max 5 kg / макс. 5 кг
B - 25 cm / 25 см
C - 15 cm / 15 см

Maksymalne obciążenie zależy od ilości wsporników i materiału z jakiego wykonana jest półka.

The maximum load depends on the number of supports and material of which the self is made.

Максимальная нагрузка зависит от количества кронштейнов и материала, из которого изготовлена полка.

Podpórka PELIKAN mała Shelf support PELIKAN small Полкодержатель PELIKAN маленький

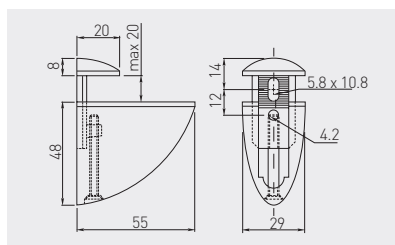

		
PP-MP0055-01	chrom / chrome / хром	ZnAl
PP-MP0055-02	satyna / satin / сатин	
PP-MP0055-05	aluminium / aluminium / алюминий	
PP-MP0055-06	stal szorstkowana / brushed steel / шлифованная сталь	
PP-MP0055-10	biały / white / белый	
PP-MP0055-20	czarny / black / чёрный	

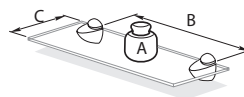

A - max 8 kg / макс. 8 кг
B - 40 cm / 40 см
C - 20 cm / 20 см

Maksymalne obciążenie zależy od ilości wsporników i materiału z jakiego wykonana jest półka.

The maximum load depends on the number of supports and material of which the self is made.

Максимальная нагрузка зависит от количества кронштейнов и материала, из которого изготовлена полка.

Podpórka PELIKAN średnia Shelf support PELIKAN medium Полкодержатель PELIKAN средний

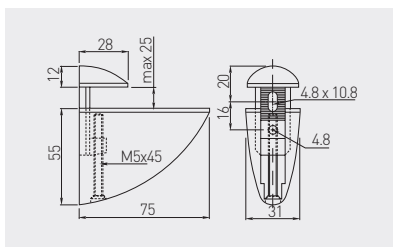

PP-SP0075-01	chrom / chrome / хром	ZnAl
PP-SP0075-02	satyna / satin / сатин	
PP-SP0075-05	aluminium / aluminium / алюминий	
PP-SP0075-06	stal szcztokowana / brushed steel шлифованная сталь	

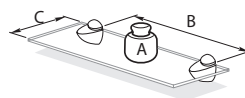

A - max 10 kg / макс. 10 кг
B - 50 cm / 50 см
C - 25 cm / 25 см

Maksymalne obciążenie zależy od ilości wsporników i materiału z jakiego wykonana jest półka.
The maximum load depends on the number of supports and material of which the self is made.

Максимальная нагрузка зависит от количества кронштейнов и материала, из которого изготовлена полка.

Podpórka PELIKAN duża Shelf support PELIKAN large Полкодержатель PELIKAN большой

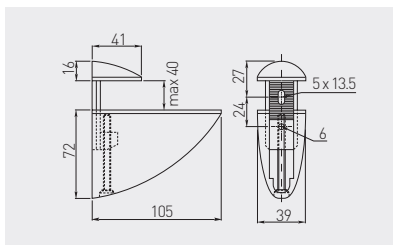

PP-DP0105-01	chrom / chrome / хром	ZnAl
PP-DP0105-02	satyna / satin / сатин	
PP-DP0105-05	aluminium / aluminium / алюминий	
PP-DP0105-06	stal szcztokowana / brushed steel шлифованная сталь	

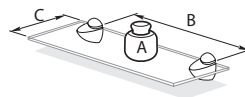

A - max 12 kg / макс. 12 кг
B - 60 cm / 60 см
C - 30 cm / 30 см

Maksymalne obciążenie zależy od ilości wsporników i materiału z jakiego wykonana jest półka.
The maximum load depends on the number of supports and material of which the self is made.

Максимальная нагрузка зависит от количества кронштейнов и материала, из которого изготовлена полка.

Podpórka GS01 Shelf support GS01 Полкодержатель GS01

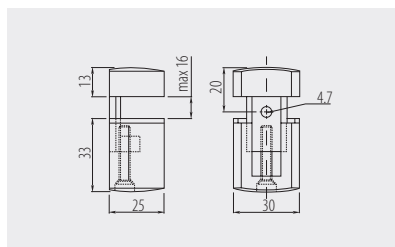

PP-00GS01-01	chrom / chrome / хром	ZnAl
PP-00GS01-02	satyna / satin / сатин	
PP-00GS01-05	aluminium / aluminium / алюминий	

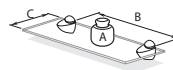

A - max 3 kg / макс. 3 кг
B - 25 cm / см
C - 15 cm / см

Maksymalne obciążenie zależy od ilości wsporników i materiału z jakiego wykonana jest półka.

The maximum load depends on the number of supports and material of which the shelf is made.

Максимальная нагрузка зависит от количества кронштейнов и материала, из которого изготовлена полка.

Podpórka GS02 Shelf support GS02 Полкодержатель GS02

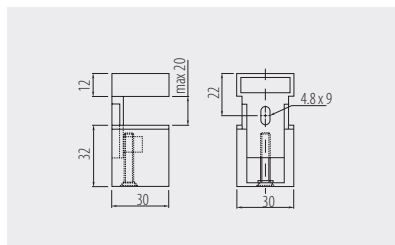

PP-00GS02-01	chrom / chrome / хром	ZnAl
PP-00GS02-02	satyna / satin / сатин	
PP-00GS02-05	aluminium / aluminium / алюминий	
PP-00GS02-06	stal szcztokowana / brushed steel / шлифованная сталь	

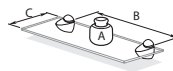

A - max 4 kg / макс. 4 кг
B - 40 cm / см
C - 20 cm / см

Maksymalne obciążenie zależy od ilości wsporników i materiału z jakiego wykonana jest półka.

The maximum load depends on the number of supports and material of which the shelf is made.

Максимальная нагрузка зависит от количества кронштейнов и материала, из которого изготовлена полка.

Podpórka GS03 Shelf support GS03 Полкодержатель GS03

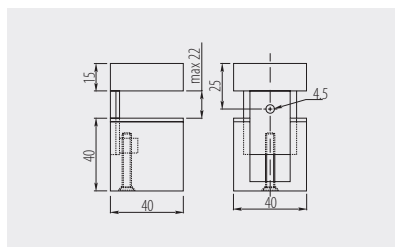

PP-00GS03-01	chrom / chrome / хром	ZnAl
PP-00GS03-02	satyna / satin / сатин	
PP-00GS03-05	aluminium / aluminium / алюминий	
PP-00GS03-06	stal szorstkowana / brushed steel / шлифованная сталь	

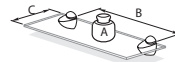

A - max 6 kg / макс. 6 кг
B - 50 cm / см
C - 25 cm / см

Maksymalne obciążenie zależy od ilości wsporników i materiału z jakiego wykonana jest półka.
The maximum load depends on the number of supports and material of which the self is made.

Максимальная нагрузка зависит от количества кронштейнов и материала, из которого изготовлена полка.

Podpórka GS04 Shelf support GS04 Полкодержатель GS04

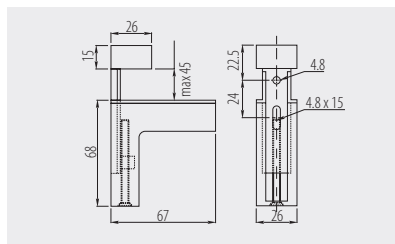

PP-00GS04-01	chrom / chrome / хром	ZnAl
PP-00GS04-02	satyna / satin / сатин	
PP-00GS04-05	aluminium / aluminium / алюминий	
PP-00GS04-06	stal szorstkowana / brushed steel / шлифованная сталь	

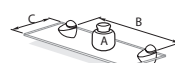

A - max 10 kg / макс. 10 кг
B - 60 cm / см
C - 30 cm / см

Maksymalne obciążenie zależy od ilości wsporników i materiału z jakiego wykonana jest półka.
The maximum load depends on the number of supports and material of which the self is made.

Максимальная нагрузка зависит от количества кронштейнов и материала, из которого изготовлена полка.

Podpórka A48 mocowana na wkręt
Shelf support A48 screw mounted
Полкодержатель A48 монтаж на винт

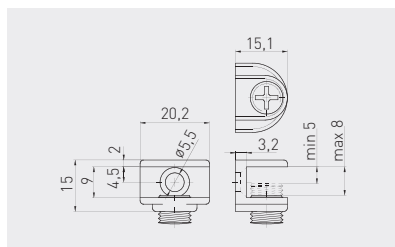

PP-GL-A48-01

chrom / chrome / хром

ZnAl



Podpórka B48 mocowana na wcisk
Shelf support B48 plug in
Полкодержатель B48 вставной

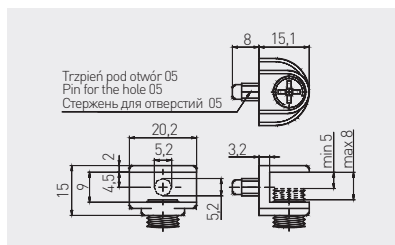

PP-GL-B48-01

chrom / chrome / хром

ZnAl



Podpórka CGP mocowana na wkręt
Shelf support CGP screw mounted
Полкодержатель CGP монтаж на винт

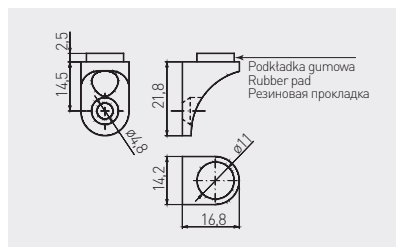

PP-GL-CGP-01	chrom / chrome / хром	ZnAl



Podpórka E410 mocowana na wcisk
Shelf support E410 plug in
Полкодержатель E410 вставной

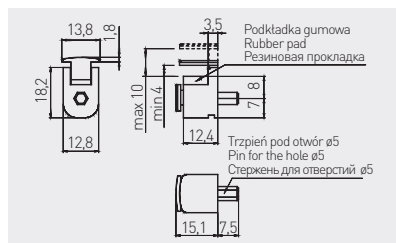

PP-GL-E410-01	chrom / chrome / хром	ZnAl



Podpórka F46 mocowana na wcisk
Shelf support F46 plug in
Полкодержатель F46 вставной

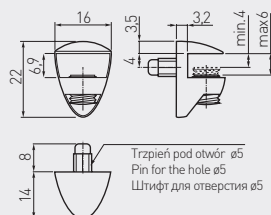

PP-GL-F46B-01



chrom / chrome / хром



ZnAl



GLASS



x 1000

Podpórka SL3
Shelf support SL3
Полкодержатель SL3

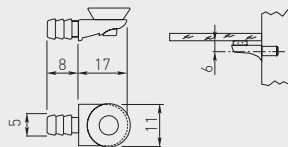

PP-SOL003-01



chrom / chrome / хром



ZnAl, tworzywo / ZnAl, plastic / ZnAl, пластмасса



GLASS



x 2000

Podpórka SL12
Shelf support SL12
Полкодержатель SL12

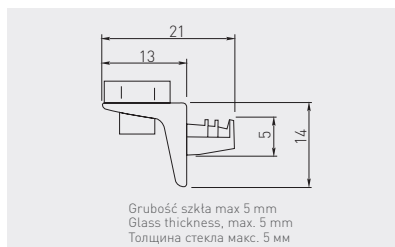

PP-S0L012-01

chrom / chrome / хром

ZnAl, tworzywo / ZnAl, plastic / ZnAl, пластмасса



Podpórka HS0
Shelf support HS0
Полкодержатель HS0



PP-HS0006-01

chrom / chrome / хром

ZnAl



Podpórka HS2
Shelf support HS2
Полкодержатель HS2

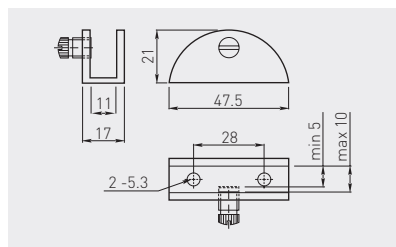

PP-HS2710-01

chrom / chrome / хром

ZnAl

GLASS

x 300

Podpórka J63
Shelf support J63
Полкодержатель J63

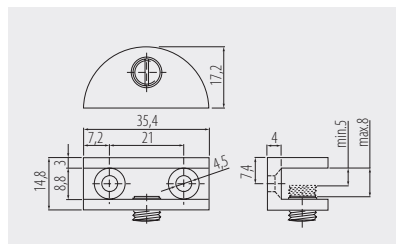

MC-J63-01

chrom / chrome / хром

MC-J63-06

stal szcztokowana / brushed steel / шлифованная сталь





ZnAl

GLASS

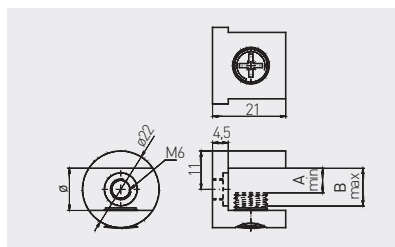
x 100

Podpórka J65
Shelf support J65
Полкодержатель J65







		 mm	 mm	 mm		
MC-J65-08-01		8	4	8	chrom / chrome / хром	ZnAl
MC-J65-08-05		8	4	8	stal szcztokowana / brushed steel / шлифованная сталь	
MC-J65-10-01		10	6	10	chrom / chrome / хром	
MC-J65-10-05		10	6	10	stal szcztokowana / brushed steel / шлифованная сталь	
MC-J65-12-01		12	7	11	chrom / chrome / хром	
MC-J65-12-05		12	7	11	stal szcztokowana / brushed steel / шлифованная сталь	

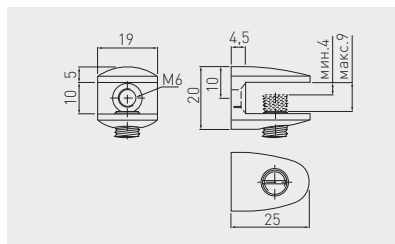

Podpórka J123
Shelf support J123
Полкодержатель J123



					
MC-J123-01				chrom / chrome / хром	ZnAl
MC-J123-05				stal szcztokowana / brushed steel / шлифованная сталь	



Podpórka K135
Shelf support K135
Полкодержатель K135

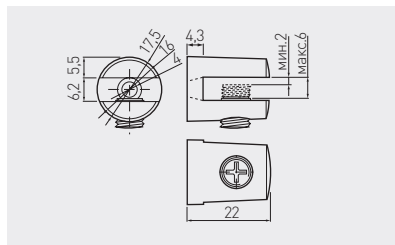

MC-K135-06-01



chrom / chrome / хром



ZnAl



Mocowanie J01
Fixture J01
Крепление J01

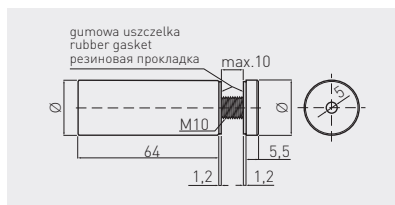

MC-J01A-12-01



mm

12 chrom / chrome / хром



12 stal szcztokowana / brushed steel / шлифованная сталь

stal
steel
сталь

160

16 chrom / chrome / хром

60

16 stal szcztokowana / brushed steel / шлифованная сталь

40

19 chrom / chrome / хром

19 stal szcztokowana / brushed steel / шлифованная сталь

25 chrom / chrome / хром

10

25 stal szcztokowana / brushed steel / шлифованная сталь



Mocowanie J02
Fixture J02
Крепление J02

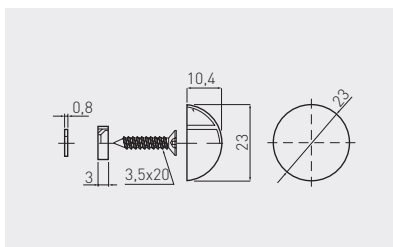

MC-J02A-25-01	23 mm	chrom / chrome / хром	stal / steel / сталь



Mocowanie J04
Fixture J04
Крепление J04

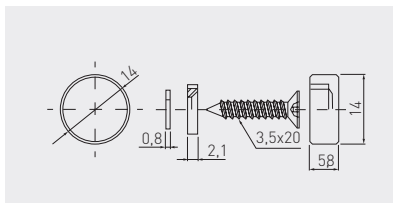

MC-J04A2-14-01	14	chrom / chrome / хром	ZnAl	300
MC-J04A2-14-06	14	stal szcztokowana / brushed steel / шлифованная сталь		
MC-J04A2-18-01	18	chrom / chrome / хром	ZnAl	200
MC-J04A2-22-01	22	chrom / chrome / хром		
MC-J04A2-22-06	22	stal szcztokowana / brushed steel / шлифованная сталь		



Mocowanie J60
Fixture J60
Крепление J60

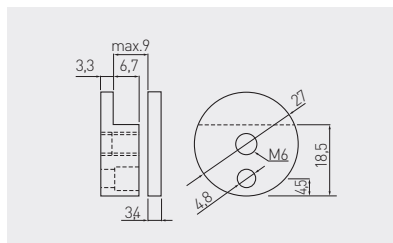

		
MC-J60A27-01	chrom / chrome / хром	ZnAl
MC-J60A27-06	stal szcztokowana / brushed steel / шлифованная сталь	



Mocowanie J62
Fixture J62
Крепление J62

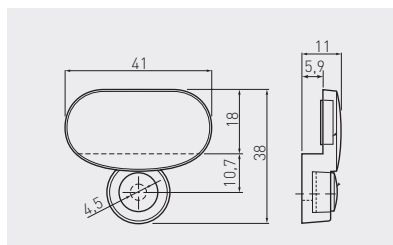

		
MC-J62-06	stal szcztokowana / brushed steel / шлифованная сталь	ZnAl



Mocowanie K90
Fixture K90
Крепление K90

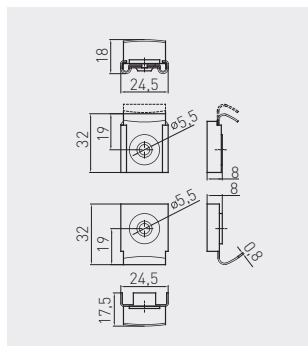

MC-K090-AR-01



chrom / chrome / хром



stal / steel / сталь



GLASS



x 360

Mocowanie K91
Fixture K91
Крепление K91

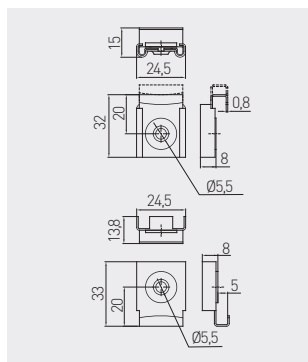

MC-K091-SQ-01



chrom / chrome / хром



stal / steel / сталь



GLASS



x 360

Podpórka GL
Shelf support GL
Полкодержатель GL

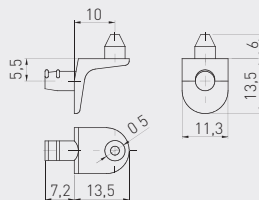

PP-GL-DR5-01



chrom / chrome / хром



ZnAl



WOOD



BOARD



x 3000

Podpórka SAFETY
Shelf support SAFETY
Полкодержатель SAFETY

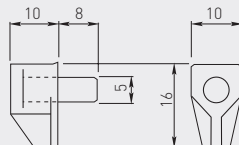

PP-SPL001-01

przeźroczysty
transparent
прозрачныйstal, tworzywo
steel, plastic
сталь, пластмасса

WOOD



BOARD



x 5000

Podpórka MR-11
Shelf support pin MR-11
Полкодержатель MR-11

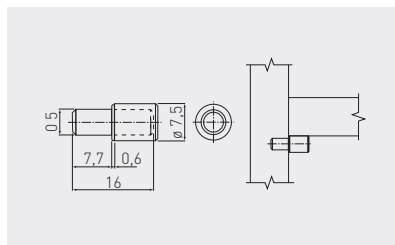

MR-ZSL011-01	z nakładką with plastic coating с накладкой	chrom / chrome / хром	stal / steel / сталь
MR-TDL011-01	bez nakładki without plastic coating без накладки		



Podpórka SMART
Shelf support SMART
Полкодержатель SMART

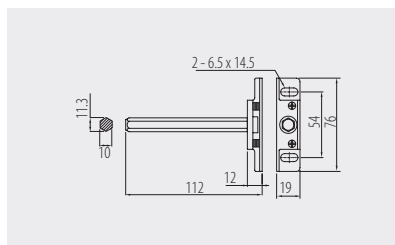

PP-SMART-000	srebrny / silver / серебристый	stal / steel / сталь



Podpórka CLEAR
Shelf support CLEAR
Полкодержатель CLEAR



PP-NW09X90B	9	90	10	brąz brown коричневый	stal steel сталь	200
PP-NW10X100B	10	110	15			
PP-NW10X145B	10	145	15			
PP-NW12X120B	12	120	15			
PP-NW14X120B	14	120	25			100
PP-NW14X140B	14	140	25			
PP-NW14X165B	14	165	25			

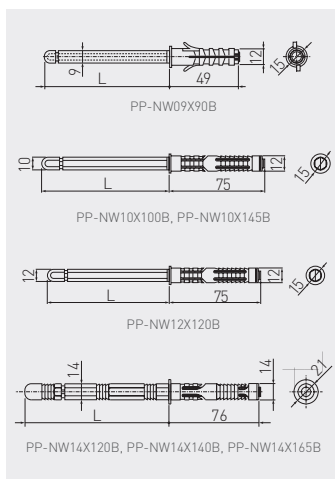

Podpórka LUK pod półkę
Shelf support bracket LUK
Полкодержатель LUK



PP-LUK-00-01	30 / 2 szt. 30 / 2 pcs. 30 / 2 шт.	chrom / chrome / хром	stal steel сталь
PP-LUK-00-02		satyna / satin / сатин	
PP-LUK-00-05		aluminium / aluminium / алюминий	

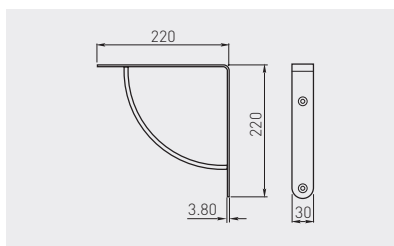

Podpórka WB-24 pod półkę
Shelf support bracket WB-24
Полкодержатель WB-24

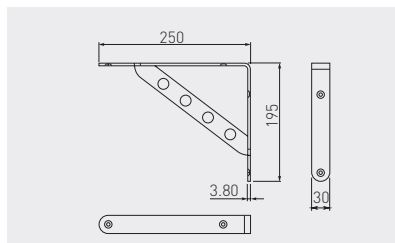

WB-073024-01	30 / 2 szt. 30 / 2 pcs.	chrom / chrome / хром	stal / steel / сталь
WB-073024-06	30 / 2 szt. 30 / 2 pcs.	stal szcztokowana / brushed steel / шлифованная сталь	



Podpórka WB-25 pod półkę
Shelf support bracket WB-25
Полкодержатель WB-25

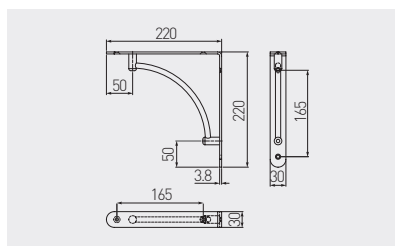

WB-073025-01	30 / 2 szt. 30 / 2 pcs.	chrom / chrome / хром	stal / steel / сталь
WB-073025-06	30 / 2 szt. 30 / 2 pcs.	stal szcztokowana / brushed steel / шлифованная сталь	



Podpórka WB-26 pod półkę
Shelf support bracket WB-26
Полкодержатель WB-26

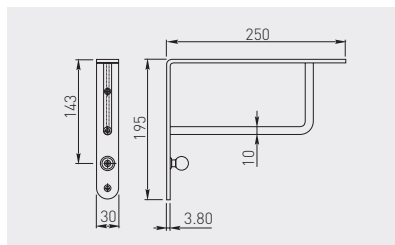

WB-073026-01		30 / 2 szt. 30 / 2 pcs.	chrom / chrome / хром	stal / steel / сталь
WB-073026-06		30 / 2 szt. 30 / 2 шт.	stal szorstkowana / brushed steel / шлифованная сталь	



Podpórka WS12
Shelf support bracket WS12
Полкодержатель WS12

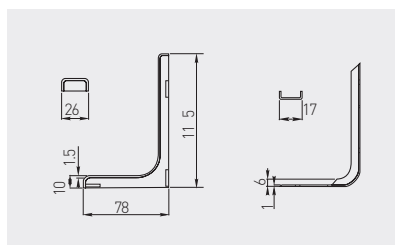

WB-WS-12-001		120	8 / 2 szt. 8 / 2 pcs. 8 / 2 шт.	chrom / chrome / хром	tworzywo plastic пластмасса
WB-WS-12-010				biały / white / белый	
WB-WS-12-020				czarny / black / чёрный	
WB-WS-12-030				brąz / brown / коричневый	
WB-WS-12-031				ciemny brąz / dark brown / темно-коричневый	
WB-WS-12-032				jasny brąz / light brown / светло-коричневый	
WB-WS-12-033				kalwados / calvados / кальвадос	
WB-WS-12-060				szary / gray / серый	





Podpórka WS18

Shelf support bracket WS18

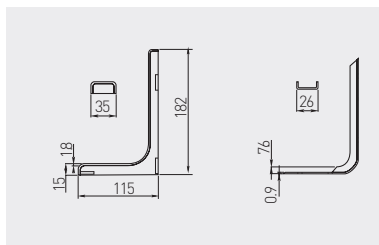
Полкодержатель WS18



	 L mm	 kg		
WB-WS-18-001	180	9,5 / 2 szt. 9,5 / 2 pcs. 9,5 / 2 шт.	chrom / chrome / хром	tworzywo plastic платмасса
WB-WS-18-010	180		biały / white / белый	
WB-WS-18-020	180		czarny / black / чёрный	
WB-WS-18-030	180		brąz / brown / коричневый	
WB-WS-18-031	180		ciemny brąz / dark brown / темно-коричневый	
WB-WS-18-032	180		jasny brąz / light brown / светло-коричневый	
WB-WS-18-033	180		kalwados / calvados / кальвадос	
WB-WS-18-060	180		szary / gray / серый	





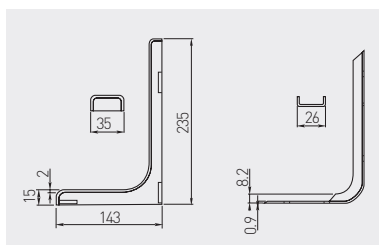

Podpórka WS24

Shelf support bracket WS24

Полкодержатель WS24







	 L mm	 kg		
WB-WS-24-001	240	11 / 2 szt. 11 / 2 pcs. 11 / 2 шт.	chrom / chrome / хром	tworzywo plastic платмасса
WB-WS-24-010	240		biały / white / белый	
WB-WS-24-020	240		czarny / black / чёрный	
WB-WS-24-030	240		brąz / brown / коричневый	
WB-WS-24-031	240		ciemny brąz / dark brown / темно-коричневый	
WB-WS-24-032	240		jasny brąz / light brown / светло-коричневый	
WB-WS-24-033	240		kalwados / calvados / кальвадос	
WB-WS-24-060	240		szary / gray / серый	

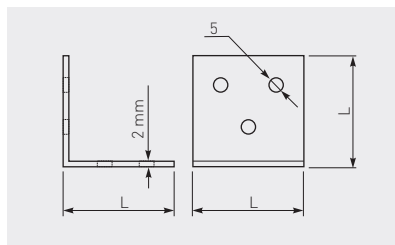



Kątownik FS01 szeroki
Angle bracket FS01
Широкий крепежный уголок FS01

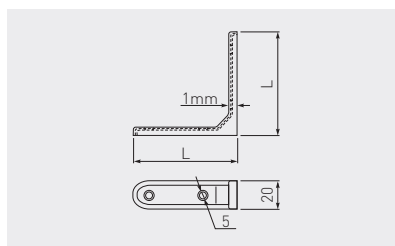

	 L mm			
KW-FS0125-01	25 x 25 x 24	chrom / chrome / хром	stal / steel / сталь	1500
KW-FS0140-01	40 x 40 x 40			400

Kątownik FS03 wzmocniony
Angle bracket FS03 reinforced
Усиленный крепежный уголок FS03



	 L mm			
KW-FS0335-01	35 x 35 x 20	chrom / chrome / хром	stal / steel / сталь	1300
KW-FS0350-01	50 x 50 x 20			700
KW-FS0375-01	75 x 75 x 20			400

Kątownik FS04 standardowy
 Angle bracket FS04 standard
 Стандартный крепежный уголок FS04

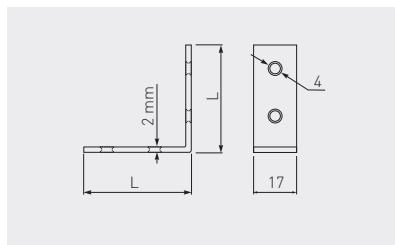

	 L mm			
KW-FS0425-03	25 x 25 x 17	mosiądz / brass / латунь	stal / steel / сталь	1500
KW-FS0430-03	30 x 30 x 17			1400
KW-FS0440-03	40 x 40 x 17			800
KW-FS0450-03	50 x 50 x 17			600
KW-FS0460-03	60 x 60 x 17			500
KW-FS0475-03	75 x 75 x 17			400

Kątownik FS06 narożnikowy
 Corner bracket FS06
 Угловой крепежный уголок FS06

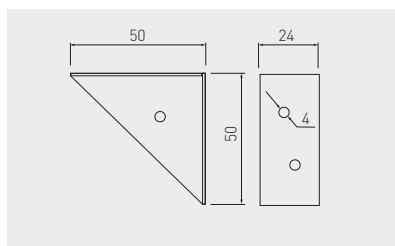

	 L mm		
KW-FS0650-01	50 x 50 x 24	chrom / chrome / хром	stal / steel / сталь



Narożnik MONT pojedynczy Corner bracket MONT single Одинрный уголок MONT

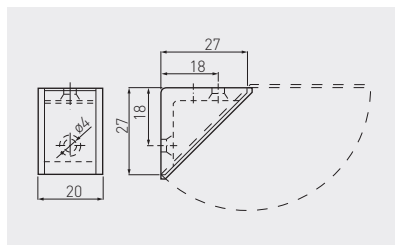
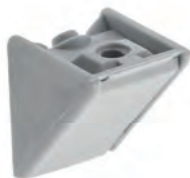

PP-PMONT0M-01	biały / white / белый	tworzywo plastic пластмасса
PP-PMONT0M-07	ciemny brąz / dark brown / темно-коричневый	
PP-PMONT0M-08	szary / gray / серый	
PP-PMONT0M-11	czarny / black / чёрный	
PP-PMONT0M-20	mahoń / mahogany / красное дерево	
PP-PMONT0M-22	kość stoniowa / ivory / слоновая кость	



Narożnik MONT podwójny Corner bracket MONT double Двойной уголок MONT

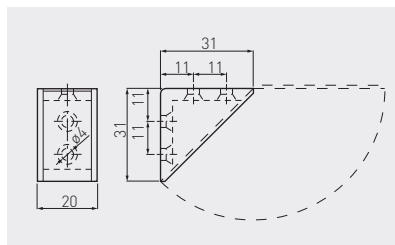

PP-PMONT0D-01	biały / white / белый	tworzywo plastic пластмасса
PP-PMONT0D-07	jasny brąz / light brown / светло-коричневый	
PP-PMONT0D-08	szary / gray / серый	
PP-PMONT0D-11	czarny / black / чёрный	
PP-PMONT0D-20	mahoń / mahogany / красное дерево	
PP-PMONT0D-22	kość stoniowa / ivory / слоновая кость	
PP-PMONT0D-41	olcha / alder / ольха	
PP-PMONT0D-50	beż / beige / бежевый	
PP-PMONT0D-724	wiśnia / cherry / вишня	
PP-PMONT0D-732	ciemny brąz / dark brown / темно-коричневый	



Narożnik NARS pojedynczy Corner bracket NARS single Одinarsый уголок NARS

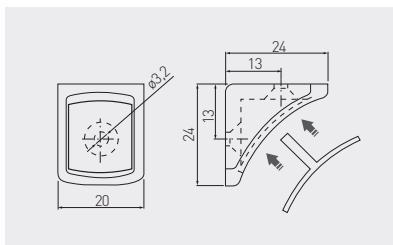

PM-NAR1003-512	kość stoniowa / ivory / слоновая кость	tworzywo plastic пластмасса
PM-NAR1003-645	szary / gray / серый	
PM-NAR1003-677	czarny / black / чёрный	
PM-NAR1003-680	biały / white / белый	
PM-NAR1003-695	srebrny / silver / серебристый	
PM-NAR1003-725	jasny brąz / light brown / светло-коричневый	
PM-NAR1003-728	beż / beige / бежевый	
PM-NAR1003-731	mahoń / mahogany / красное дерево	
PM-NAR1003-732	ciemny brąz / dark brown / темно-коричневый	
PM-NAR1003-770	grusza / pear / груша	
PM-NAR1003-771	olcha / alder / ольха	



Narożnik NARS podwójny Corner bracket NARS double Двойной уголок NARS

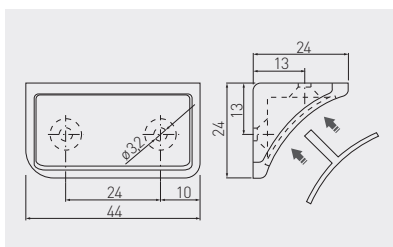

PM-NAR1004-512	kość stoniowa / ivory / слоновая кость	tworzywo plastic пластмасса
PM-NAR1004-645	szary / gray / серый	
PM-NAR1004-677	czarny / black / чёрный	
PM-NAR1004-680	biały / white / белый	
PM-NAR1004-695	aluminium / aluminium / алюминий	
PM-NAR1004-724	wiśnia / cherry / вишня	
PM-NAR1004-725	jasny brąz / light brown / светло-коричневый	
PM-NAR1004-728	beż / beige / бежевый	
PM-NAR1004-731	mahoń / mahogany / красное дерево	
PM-NAR1004-732	ciemny brąz / dark brown / темно-коричневый	
PM-NAR1004-770	grusza / pear / груша	
PM-NAR1004-771	olcha / alder / ольха	



Stabilizator ścianki tylnej
Rear stabilizer
Стабилизатор задней стенки

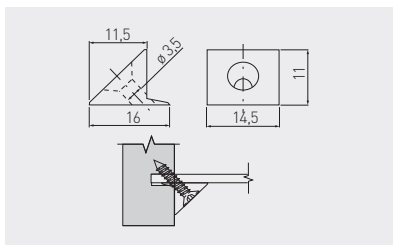

WZ-SCTYLPR-WK	z wkrętem 3,5 x 20 with screw 3,5 x 20 с шурупом 3,5 x 20	biały white белый	tworzywo plastic пластмасса
WZ-SCTYLPR-BWK	bez wkręta without screw без шурупа		



Zawieszka niewidoczna FORCE
Invisible kitchen hanger FORCE
Скрытый навес FORCE

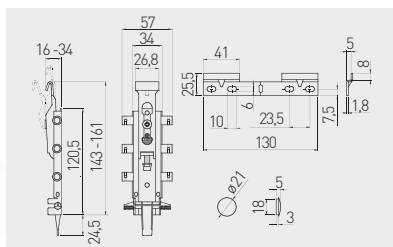

ZK-FORCE-KPL	100 / 2 szt. 100 / 2 pcs. 100 / 2 шт.	srebrny / silver / серебристый	ZnAl, stal / ZnAl, steel / ZnAl, сталь
--------------	---	--------------------------------	--



Zawieszka kuchenna R0 z regulacją
Kitchen hanger R0 adjustable
Навес кухонный R0 с регулировкой

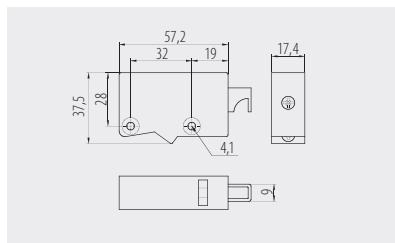

ZK-ZAW-R0-10	50 / 2 szt. 50 / 2 pcs. 50 / 2 шт.	biały / white / белый	
ZK-ZAW-R0-30		brąz / brown / коричневый	
ZK-ZAW-R0-32		jasny brąz / light brown / светло-коричневый	
		stal, tworzywo steel, plastic сталь, пластмасса	



Zawieszka kuchenna R1
Kitchen hanger R1
Навес кухонный R1

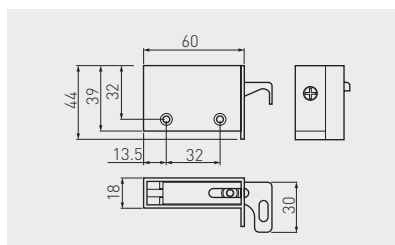

ZK-R1-KPL-10	90 / 2 szt. 90 / 2 pcs. 90 / 2 шт.	biały / white / белый	
ZK-R1-KPL-30		brąz / brown / коричневый	
		stal, tworzywo steel, plastic сталь, пластмасса	



Zawieszka kuchenna STRONG

Kitchen hanger STRONG

Навес кухонный STRONG

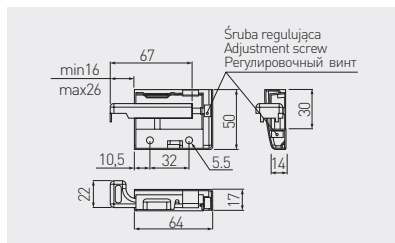

ZK-STRONG-L1	130 / 2 szt. 130 / 2 pcs.	lewa / left / левый	srebrny silver	stal, tworzywo steel, plastic
ZK-STRONG-P1	130 / 2 szt. 130 / 2 pcs.	prawa / right / правый	srebrzysty silver	stal, tworzywo steel, plastic



Zaślepka do zawieszki STRONG

Hanger caps STRONG

Заглушки для навесов STRONG

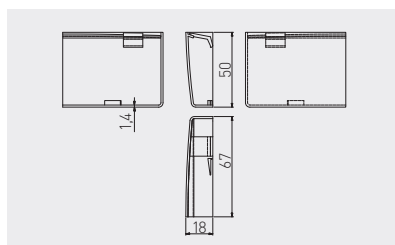

ZK-ZAS-L0-10	lewa / left / левая	biały / white / белый	tworzywo plastic пластмасса
ZK-ZAS-L0-15		beż / beige / бежевый	
ZK-ZAS-L0-31		ciemny brąz / dark brown / темно-коричневый	
ZK-ZAS-L0-32		jasny brąz / light brown / светло-коричневый	
ZK-ZAS-P0-10	prawa / right / правая	biały / white / белый	
ZK-ZAS-P0-15		beż / beige / бежевый	
ZK-ZAS-P0-31		ciemny brąz / dark brown / темно-коричневый	
ZK-ZAS-P0-32		jasny brąz / light brown / светло-коричневый	



Listwa montażowa
Mounting strip
Монтажная планка

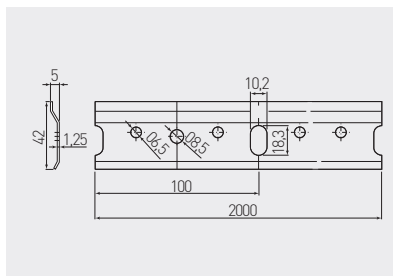

LO-M2M-00-125



2000



osynek
galvanized
гальваніка





stal
steel
сталь

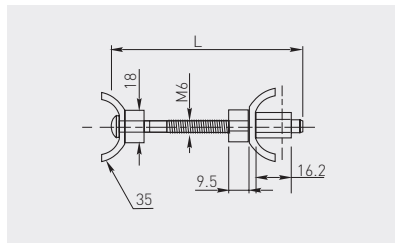

Złącze do blatów śrubowe
 Concealed worktop connector
 Стяжка для столешниц





		 mm		
EM-SBL060-01		60	chrom / chrome / хром	stal, tworzywo steel, plastic сталь, пластмасса
EM-SBL100-01		100		
EM-SBL150-01		150		

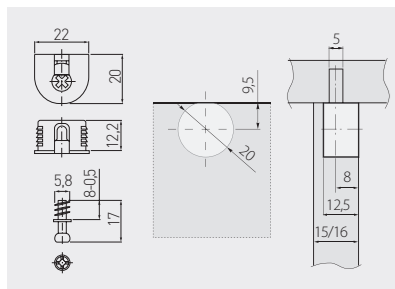

Złącze mimośrodowe
 Eccentric connecting fitting
 Экцентрик



		 mm			
MM-FI20X6X7-PL10		20	trzcień 6x7mm штифт 6x7mm	biały / white / белый	ZnAl, tworzywo ZnAl, plastic ZnAl, пластмасса
MM-FI20X6X7-PL20				czarny / black / чёрный	
MM-FI20X6X7-PL30				brąz / brown / коричневый	
MM-FI20X6X7-PL80				szary / gray / серый	
MM-FI20X6X7-ZN				srebrny / silver / серебристый	



Szybkozłaczce Threaded sleeve, with internal thread Стяжки

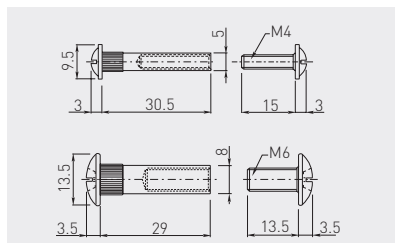







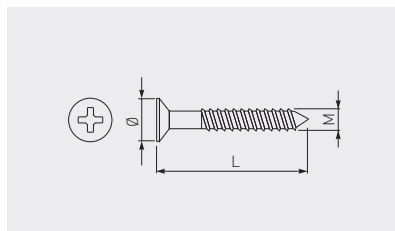

		 mm		
SZ-005-00-01		5	chrom / chrome / хром	stal / steel / сталь
SZ-008-00-01		8		



Wkręt do drewna Screw for wood Мебельные метизы



		 mm		
WK-D0310-001		3 x 10	chrom chrome хром	stal steel сталь
WK-D0313-001		3 x 13		
WK-D0316-001		3 x 16		
WK-D0320-001*		3 x 20		
WK-D0325-001*		3 x 25		
WK-D0330-001*		3 x 30		
WK-D0416-001		4 x 16		
WK-D0420-001		4 x 20		
WK-D0425-001*		4 x 25		

		 mm		
WK-D0430-001		4 x 30	chrom chrome хром	stal steel сталь
WK-D0435-001		4 x 35		
WK-D0440-001*		4 x 40		
WK-D0460-001*		4 x 60		
WK-D3516-001		3,5 x 16		
WK-D3520-001*		3,5 x 20		
WK-D3525-001		3,5 x 25		
WK-D3530-001		3,5 x 30		

*Produkt dostępny na indywidualne zamówienie / Available for special orders /
Товар доступен под заказ



Konfirmat
 Confirnat screw
 Конфирмат

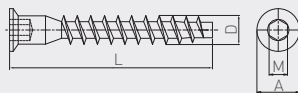

		L	D	A	M
WK-CF6450-01	6,4 x 50	50	6,4	9,5	4
WK-CF0750-01	7 x 50	50	7	10	4



WK-CF6450-01	chrom / chrome / хром	stal / steel / сталь
WK-CF0750-01		



Magnes MENSA
 Magnetic catch MENSA
 Магнит MENSA

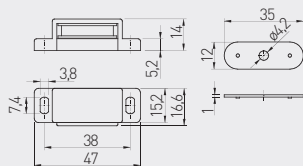

MG-MENSA-010	biały / white / белый	stal, tworzywo steel, plastic сталь, пластмасса
MG-MENSA-030	brąz / brown / коричневый	



Profil meblowy PFM - typ H
 Furniture edge profile PFM - type H
 Мебельный профиль PFM - тип H

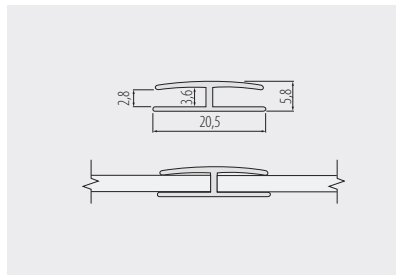

	 L mm		
PM-PFMH50-10	2000	biały / white / белый	tworzywo plastic пластмасса
PM-PFMH51-10	2000	ciemny brąz / dark brown / темно-коричневый	
PM-PFMH53-10	2000	jasny brąz / light brown / светло-коричневый	
PM-PFMH61-10	2000	ciemny mahoń / dark mahogany / темное красное дерево	
PM-PFMH64-10	2000	mahoń / mahogany / красное дерево	
PM-PFMH69-10	2000	beż / beige / бежевый	
PM-PFMH50-24	2400	biały / white / белый	
PM-PFMH50-25	2500	biały / white / белый	
PM-PFMH55-25	2500	czarny / black / чёрный	
PM-PFMH64-25	2500	mahoń / mahogany / красное дерево	



Listwa ozdobna płaska
Flat decorative strip
Плоская декоративная планка



Taśma samoprzylepna
Self-adhesive tape
Самоклеящаяся лента

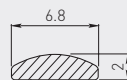

	 L mm		
LO-00-00-001	2000	chrom / chrome / хром	tworzywo plastic пластмасса
LO-00-00-003	2000	mosiądz / brass / латунь	



Listwa ozdobna wypukła
Convex decorative strip
Выпуклая декоративная планка



Taśma samoprzylepna
Self-adhesive tape
Самоклеящаяся лента

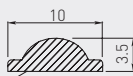

	 L mm		
LO-P0-00-010	2000	biały / white / белый	tworzywo plastic пластмасса
LO-P0-00-030	2000	brąz / brown / коричневый	



Listwa boczna 38
Worktop edging strip 38
Торцевая планка 38

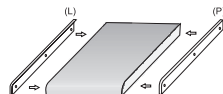

Do blatów o grubości 38 mm
For worktops 38 mm thick
Для столешниц толщиной 38 мм

				
LMB-BOCZ38L-ALU	lewa / left / левая	600	aluminium aluminium алюминий	aluminium aluminium алюминий
LMB-BOCZ38P-ALU	prawa / right / правая			



Listwa kątowa 28
Worktop angle edging strip 28
Угловая планка 28

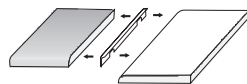

Do blatów o grubości 28 mm
For worktops 28 mm thick
Для столешниц толщиной 28 мм

			
LMB-KAT28-ALU	600	aluminium aluminium алюминий	aluminium aluminium алюминий



Listwa kąтова 38
Worktop angle edging strip 38
Угловая планка 38

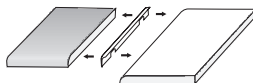

Do blatów o grubości 38 mm
For worktops 38 mm thick
Для столешниц толщиной 38 мм

			
LMB-KAT38-ALU	600	aluminium aluminium алюминий	aluminium aluminium алюминий



Listwa szczelinowa 28
Worktop joining strip 28
Щелевая планка 28

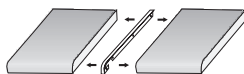

Do blatów o grubości 28 mm
For worktops 28 mm thick
Для столешниц толщиной 28 мм

			
LMB-SZCZ28-ALU	600	aluminium aluminium алюминий	aluminium aluminium алюминий



Listwa szczelinowa 38
Worktop joining strip 38
Щелевая планка 38

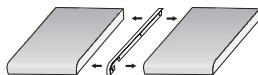

Do blatów o grubości 38 mm
For worktops 38 mm thick
Для столешниц толщиной 38 мм



LMB-SZCZ38-ALU	600	aluminium aluminium алюминий	aluminium aluminium алюминий
----------------	-----	------------------------------------	------------------------------------



Drążek owalny
Oval wardrobe rail
Овальная труба для гардероба

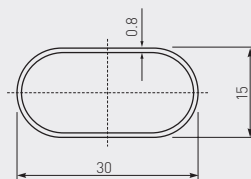

	 L mm		
RR-CH-0W-000	3000	chrom / chrome / хром	stal / steel / сталь



Mocowanie RDR do drążka owalnego
RDR mounting bracket for oval wardrobe rail
Крепление RDR для овальной трубы

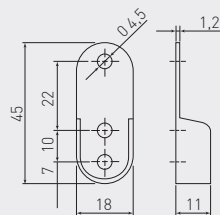

		
MR-RDR0-0000	chrom / chrome / хром	stal / steel / сталь



Uchwyt WP-28 do rury owalnej
 WP-28 angle bracket for oval rail
 Крепление дистанционное для овальной трубы

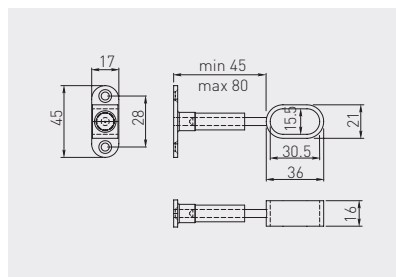



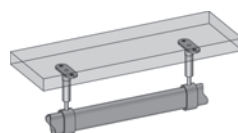



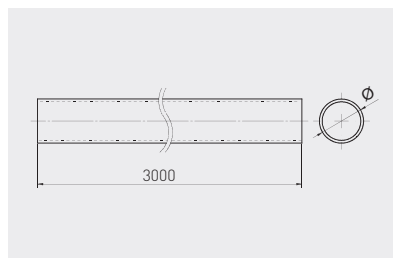





		
MR-WP-028-01	chrom / chrome / хром	ZnAl



Drążek okrągły
 Round wardrobe rail
 Мебельная штанга



					
RR-161030H01	16	1	3000	chrom chrome хром	stal steel сталь
RR-161230H01	16	1,2			
RR-250730H01	25	0,7			
RR-250830H01	25	0,8			
RR-250930H01	25	0,9			

					
RR-251030H01	25	1	3000	chrom chrome хром	stal steel сталь
RR-401230H01	40	1,2			
RR-501030H01	50	1,2			
RR-501230H01	50	1,2			



Mocowanie R-25 do drążka okrągłego
R-25 mounting bracket for round rail
Крепление R-25 для трубы

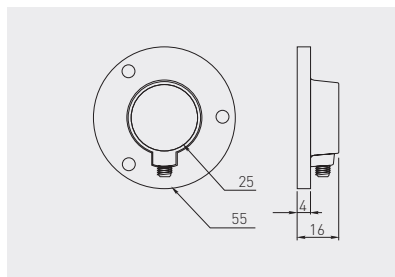

	 mm		
MR-RS025-001	25	chrom / chrome / хром	stal / steel / сталь



Mocowanie R-50 do drążka okrągłego
R-50 mounting bracket for round rail
Крепление R-50 для трубы

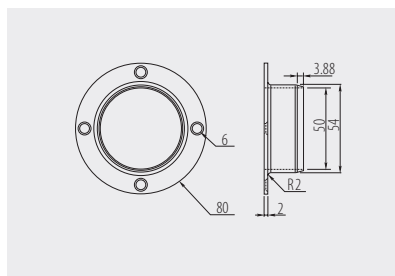

	 mm		
MR-R0050-001	50	chrom / chrome / хром	stal / steel / сталь



Mocowanie PZ-2 dolne do drążka okrągłego
 PZ-2 bottom mounting bracket for round rail
 Нижнее крепление PZ-2 для трубы

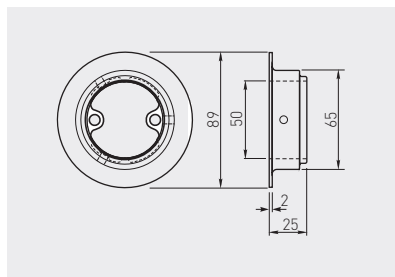

	 mm		
MR-WPZ002-01	50	chrom / chrome / хром	stal / steel / сталь



Pierścień mocujący PZ-3
 Mounting ring PZ-3
 Крепёжное кольцо PZ-3

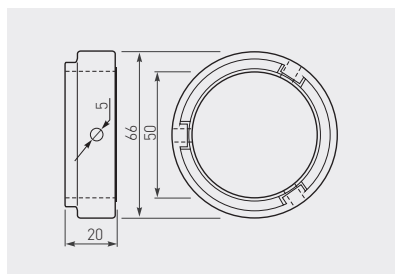

	 mm		
MR-WPZ003-01	50	chrom / chrome / хром	ZnAl



Uchwyt WP-10 dystansowy, regulowany
 WP-10 support bracket, adjustable
 Регулируемый кронштейн WP-10

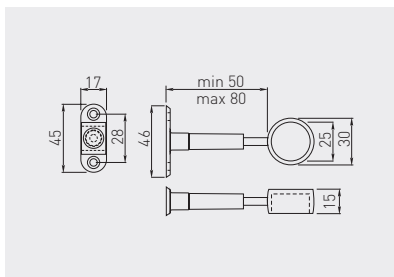

	 mm		
MR-WP-010-01	25	chrom / chrome / хром	ZnAl



Uchwyt WP-11 dystansowy, regulowany z zaślepką
 WP-11 support bracket, adjustable with cover
 Регулируемый кронштейн WP-11 с заглушкой

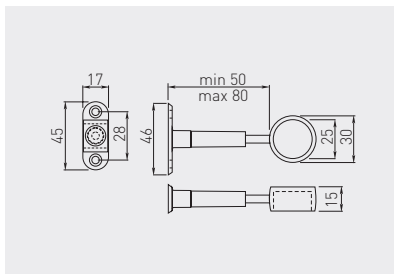

	 mm		
MR-WP-011-01	25	chrom / chrome / хром	ZnAl



Uchwyt THA-12 dystansowy, przelotowy
 THA-12 support bracket
 Опорный кронштейн THA-12 сквозной

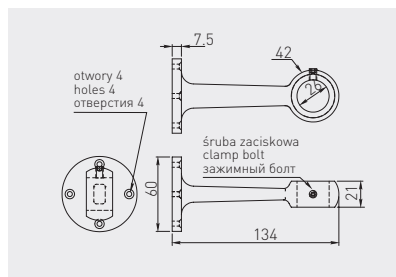

	 mm		
MR-THA12-001	25	chrom / chrome / хром	ZnAl

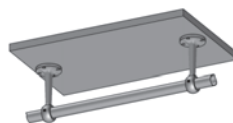

Uchwyt THB-12 dystansowy
 THB-12 support bracket
 Опорный кронштейн THB-12

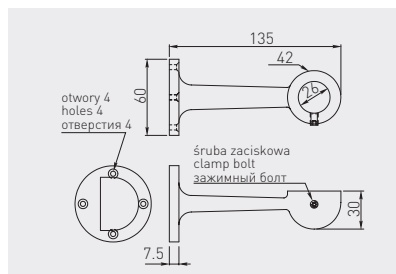

	 mm		
MR-THB12-001	25	chrom / chrome / хром	ZnAl



Łącznik WP-13
 WP-13 connector
 Соединитель WP-13

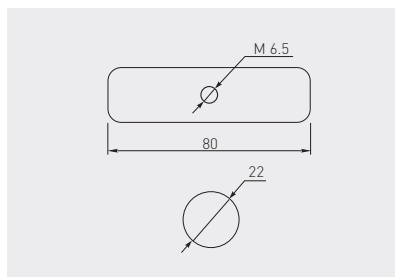

		
MR-WP013-001	осынк / galvanized / гальваника	ZnAl



Złącze TH-5 dwuramienne
 TH-5 connector
 Муфта TH-5 двухраструбная

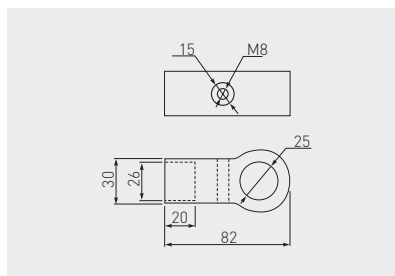

			
MR-TH005-001	25 mm	chrom / chrome / хром	ZnAl



Złącze TH-16 dwuramienne
 TH-16 connector
 Муфта двухраструбная TH-16

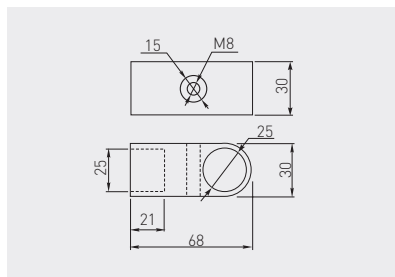

	 mm		
MR-TH016-001	25	chrom / chrome / хром	ZnAl



Złącze TH-4 dwuramienne typ T
 TH-4 connector type T
 Муфта TH-4 двухраструбная тип T

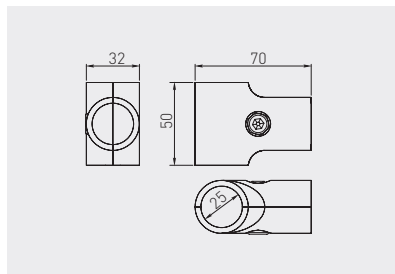

	 mm		
MR-TH004-001	25	chrom / chrome / хром	ZnAl



Zestaw złączy TH-18 typ L
 TH-18 connector type L
 Набор муфт TH-18 тип L

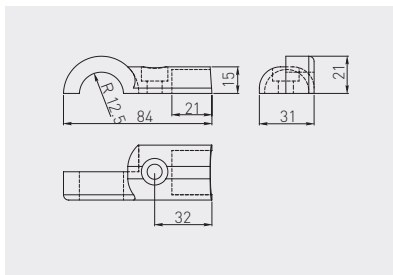

Możliwość uzyskania różnych pozożeń połączenia
 The possibility of obtaining various positions of connection
 Возможность получения разных положений соединения

MR-TH018-KPL	prawy / lewy right / left правый / левый	25 mm	chrom / chrome / хром	ZnAl



Zestaw złączy T-18 typ T
 T-18 connectors set type T
 Набор муфт TH-18 тип T

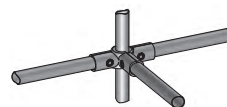
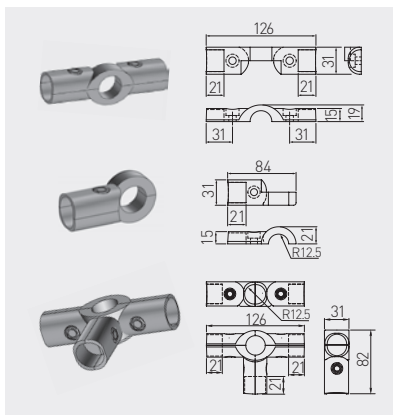

MR-T1824-KPL	25 mm	chrom / chrome / хром	ZnAl



Zestaw złączy TH-24
TH-24 connectors set
Набор муфт TH-24

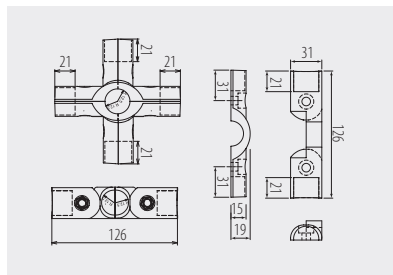

	 mm		
MR-TH024-KPL	25	chrom / chrome / хром	ZnAl



Złącze TH-11 zawiasowe
TH-11 hinge connector
Муфта шарнирная TH-11

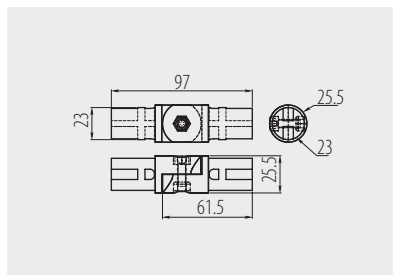

		
MR-TH011-001	chrom / chrome / хром	ZnAl



Możliwość dostosowania kąta stykaczy do założonego położenia (do 180°)

The possibility of adjustment of angle connector arms to the desired position (up to 180°)

Возможность регулировки угла стыковки соединителей к заданному положению [180°]

Złącze TH-9
TH-9 connector
Муфта TH-9



dla płyty = 18 mm
for board = 18 mm
для плиты = 18 мм

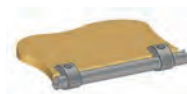
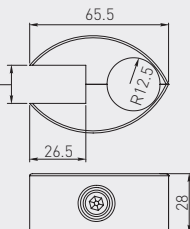

MR-TH009-001

chrom / chrome / хром

ZnAl



Zalecana grubość szkła z użyciem wkładek: od 4 do 8 mm
Recommended glass thickness with inserts: from 4 to 8 mm

Рекомендуемая толщина стекла с использованием вкладышей: от 4 до 8 мм

Złącze TH-10 dwustronne
TH-10 connector
Муфта TH-10 двухсторонняя

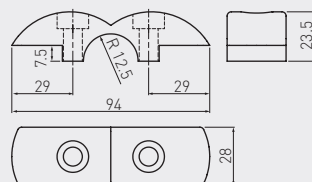

MR-TH010-001

chrom / chrome / хром

ZnAl



Zalecana grubość szkła z użyciem wkładek: od 4 do 8 mm
Recommended glass thickness with inserts: from 4 to 8 mm

Рекомендуемая толщина стекла с использованием вкладышей: от 4 до 8 мм

Zestaw złączy TH-35
TH-35 set of connectors
Набор муфт TH-35

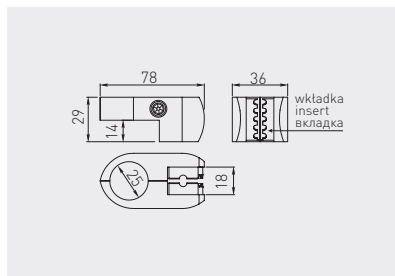

MR-TH035-KPL	25	chrom / chrome / хром	ZnAl



Zalecana grubość szkła z użyciem wkładek: od 4 do 8 mm
Recommended glass thickness with inserts: from 4 to 8 mm
Рекомендуемая толщина стекла с использованием вкладышей: от 4 до 8 мм

Złącze WP-14 dwustronne
WP-14 connector
Муфта WP-14 двухсторонняя

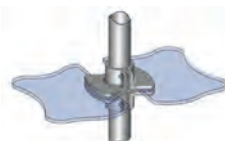
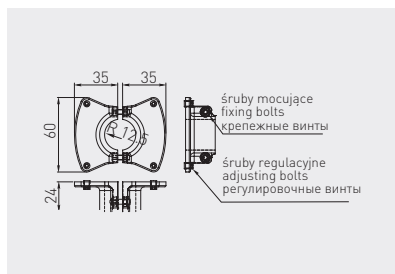

MR-WP-14-KPL	25	chrom / chrome / хром	ZnAl



Złącze WP-15
WP-15 connector
Муфта WP-15



śruby regulacyjne
adjusting bolts
регулирующие винты

śruby mocujące
fixing bolts
крепежные винты

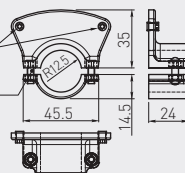

	 mm		
MR-WP-15-KPL	25	chrom / chrome / хром	ZnAl

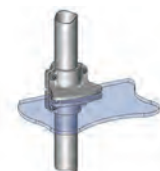

Złącze TH-1 równoległe
TH-1 connector parallel
Муфта TH-1 равнопроходная

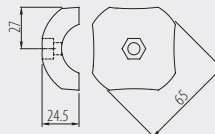





		
MR-TH001-01	chrom / chrome / хром	ZnAl

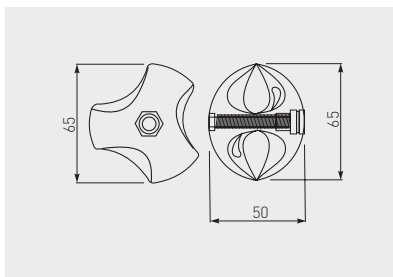

Złącze TH-2 potrójne
TH-2 connector three-way
Муфта TH-2 тройная



			
MR-TH002-L01	lewy / left / левый	chrom / chrome / хром	ZnAl
MR-TH002-P01	prawy / right / правый		



Złącze TH-18 podwójne
TH-18 double connector
Муфта TH-18 двойная

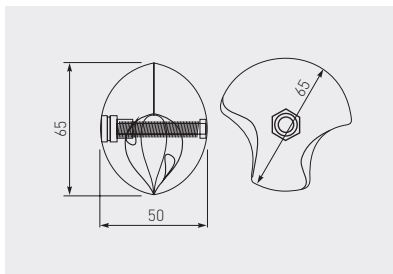

			
MR-TH018-L01	lewy / left / левый	chrom / chrome / хром	ZnAl
MR-TH018-P01	prawy / right / правый		



Zaślepka okrągła
Round end cap
Круглая заглушка

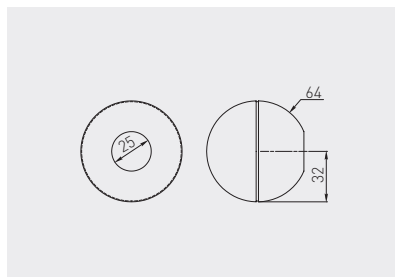

	 mm		
MR-THQZ1-001	25	chrom / chrome / хром	ZnAl



Zaślepka TH-19
TH-19 end cap
Заглушка TH-19

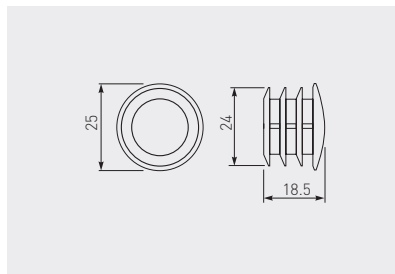

	 mm		
MR-TH019-001	25	chrom / chrome / хром	ZnAl



Stopka plastikowa zewnętrzna
Plastic end cap
Внешняя ножка, пластмассовая

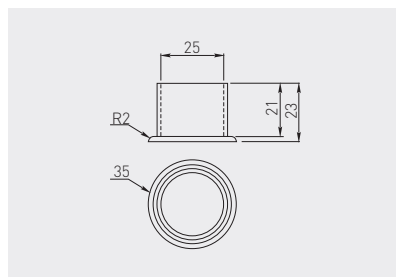



	 mm		
MR-TH019-003	25	czarny black чёрный	tworzywo plastic пластмасса

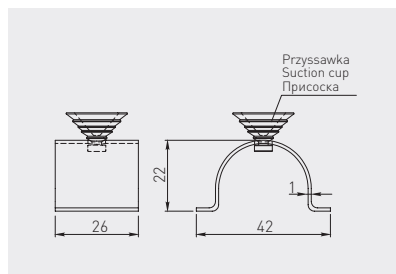

Uchwyt THA-48 z przyssawką
THA-48 handle with suction cup
Крепление THA-48 с присоской



	 mm		
MR-TH048-001	25	chrom chrome хром	stal, tworzywo steel, plastic сталь, пластмасса



Мосowanie PZ-6 górne, rozporowe
 PZ-6 expandable end support bracket
 Верхнее крепление PZ-6

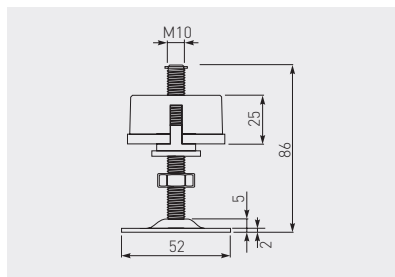

MR-WPZ006-01

50

chrom / chrome / хром

stal, tworzywo / steel, plastic / сталь, пластмасса



Uchwyt do relingu prosty
 Rail support
 Ручка для рейлинга прямая

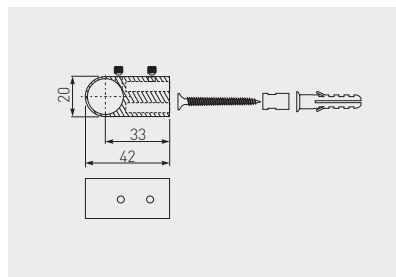

	 mm		
MR-WP2802-01	16	chrom / chrome / хром	ZnAl



Zaślepka do relingu prosta
 End cap
 Заглушка для рейлинга прямая

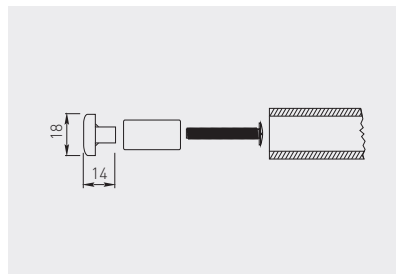

	 mm		
MR-WP2815-01	16	chrom / chrome / хром	ZnAl



Uchwyt do relingu
 Rail support
 Ручка для рейлинга

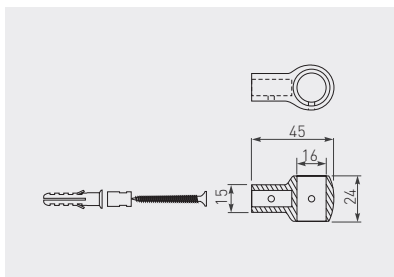





	 mm		
MR-WP2804-01	16	chrom / chrome / хром	ZnAl

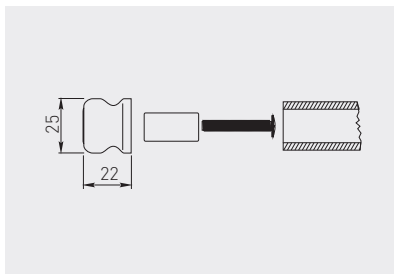

Zaślepka do relingu
 End cap
 Заглушка для рейлинга



	 mm		
MR-WP2806-01	16	chrom / chrome / хром	ZnAl, tworzywo / ZnAl, plastic / ZnAl, пластмасса



Łącznik do relingu
 Rail connector
 Соединитель для рейлинга

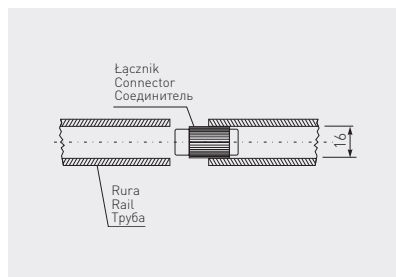

	 mm		
MR-WP2807-20	16	czarny / black / чёрный	tworzywo / plastic / пластмасса



Zaślepka do relingu z gwintem
 End cap with thread for rails
 Заглушка для рейлинга с резьбой

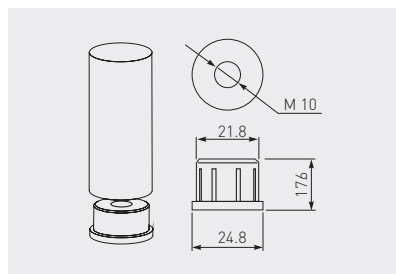

		
MR-WPZ023-01	chrom / chrome / хром	ZnAl



Haczyki do relingu PS1
 Hooks for rails PS1
 Крючки для рейлинга PS1

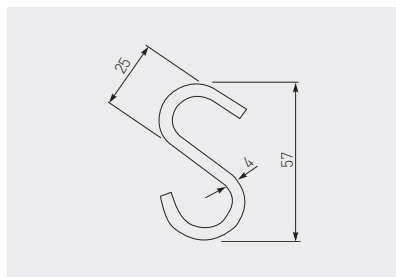

	 mm		
MR-WPS01-001	16	chrom / chrome / хром	stal / steel / сталь



Haczyki do relingu PS3
 Hooks for rails PS3
 Крючки для рейлинга PS3

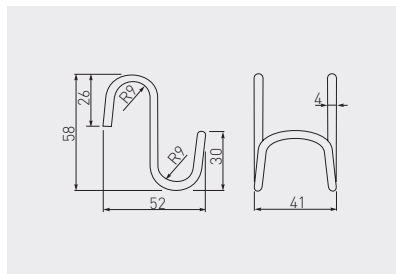

	 mm		
MR-WPS03-001	16	chrom / chrome / хром	stal / steel / сталь



Szuflada SMART na obuwie
 Pull out shoes rack SMART
 Полка SMART для обуви

NEW

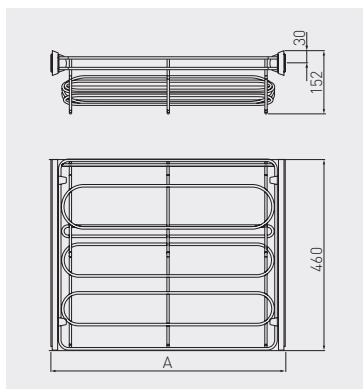

 A
 min/max

W-WOBU60-BP-60	komplet bez prowadnic set without slides комплектция без направляющих	600	pełny full полное	szary gray серый	stal, tworzywo steel, plastic сталь, пластмасса	
W-WOBU60-GX-60	na prowadnicy kulkowej H45 on ball bearing slide H45 на шариковой направляющей H45					560-568
W-WOBU60-VE-60	na prowadnicy kulkowej H45 z funkcją cichego zamknięcia on ball bearing slide H45 with soft closing на шариковой направляющей H45 с доводчиком					
W-WOBU70-BP-60	komplet bez prowadnic set without slides комплектция без направляющих	700	pełny full полное	szary gray серый	stal, tworzywo steel, plastic сталь, пластмасса	
W-WOBU70-GX-60	na prowadnicy kulkowej H45 on ball bearing slide H45 на шариковой направляющей H45					660-668
W-WOBU70-VE-60	na prowadnicy kulkowej H45 z funkcją cichego zamknięcia on ball bearing slide H45 with soft closing на шариковой направляющей H45 с доводчиком					
W-WOBU80-BP-60	komplet bez prowadnic set without slides комплектция без направляющих	800	pełny full полное	szary gray серый	stal, tworzywo steel, plastic сталь, пластмасса	
W-WOBU80-GX-60	na prowadnicy kulkowej H45 on ball bearing slide H45 на шариковой направляющей H45					760-768
W-WOBU80-VE-60	na prowadnicy kulkowej H45 z funkcją cichego zamknięcia on ball bearing slide H45 with soft closing на шариковой направляющей H45 с доводчиком					
W-WOBU90-BP-60	komplet bez prowadnic set without slides комплектция без направляющих	900	pełny full полное	szary gray серый	stal, tworzywo steel, plastic сталь, пластмасса	
W-WOBU90-GX-60	na prowadnicy kulkowej H45 on ball bearing slide H45 на шариковой направляющей H45					860-868
W-WOBU90-VE-60	na prowadnicy kulkowej H45 z funkcją cichego zamknięcia on ball bearing slide H45 with soft closing на шариковой направляющей H45 с доводчиком					

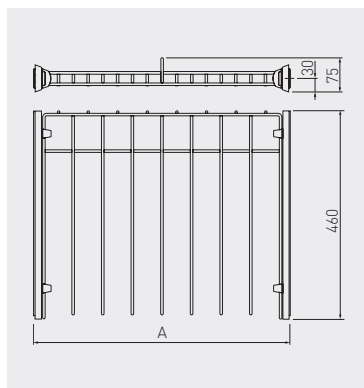

Wieszak SMART na spodnie
 SMART wardrobe trouser rack
 Вешалка SMART для брюк

NEW



A
min/max



		mm	A		
W-WSPD60-BP-60	komplet bez prowadnic set without slides комплектция без направляющих	600	560 - 568	szary gray серый	stal, tworzywo steel, plastic сталь, пластмасса
W-WSPD60-GX-60	na prowadnicy kulkowej H45 on ball bearing slide H45 на шариковой направляющей H45				
W-WSPD60-VE-60	na prowadnicy kulkowej H45 z funkcją cichego zamknięcia on ball bearing slide H45 with soft closing на шариковой направляющей H45 с доводчиком				
W-WSPD70-BP-60	komplet bez prowadnic set without slides комплектция без направляющих	700	660 - 668	szary gray серый	stal, tworzywo steel, plastic сталь, пластмасса
W-WSPD70-GX-60	na prowadnicy kulkowej H45 on ball bearing slide H45 на шариковой направляющей H45				
W-WSPD70-VE-60	na prowadnicy kulkowej H45 z funkcją cichego zamknięcia on ball bearing slide H45 with soft closing на шариковой направляющей H45 с доводчиком				
W-WSPD80-BP-60	komplet bez prowadnic set without slides комплектция без направляющих	800	760-768	szary gray серый	stal, tworzywo steel, plastic сталь, пластмасса
W-WSPD80-GX-60	na prowadnicy kulkowej H45 on ball bearing slide H45 на шариковой направляющей H45				
W-WSPD80-VE-60	na prowadnicy kulkowej H45 z funkcją cichego zamknięcia on ball bearing slide H45 with soft closing на шариковой направляющей H45 с доводчиком				
W-WSPD90-BP-60	komplet bez prowadnic set without slides комплектция без направляющих	900	860-868	szary gray серый	stal, tworzywo steel, plastic сталь, пластмасса
W-WSPD90-GX-60	na prowadnicy kulkowej H45 on ball bearing slide H45 на шариковой направляющей H45				
W-WSPD90-VE-60	na prowadnicy kulkowej H45 z funkcją cichego zamknięcia on ball bearing slide H45 with soft closing на шариковой направляющей H45 с доводчиком				



Wieszak SMART na paski i krawaty
 SMART belt and tie rack
 Вешалка для ремней и галстуков SMART

NEW

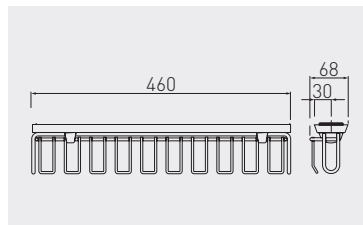

W-WKRP-BP-60	komplet bez prowadnic set without slides комплексия без направляющих			
W-WKRP-GX-60	na prowadnicy kulkowej H45 on ball bearing slide H45 на шариковой направляющей H45	pełny full полное	szary gray серый	stal, tworzywo steel, plastic сталь, пластмасса
W-WKRP-VE-60	na prowadnicy kulkowej H45 z funkcją cichego zamknięcia on ball bearing slide H45 with soft closing на шариковой направляющей H45 с доводчиком			



Kosz SMART na bieliznę
SMART wardrobe basket
Корзина для шкафа SMART

NEW

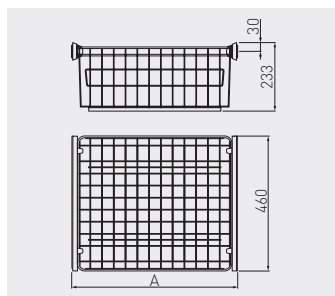

A
min/max



W-WK060-BP-60	komplet bez prowadnic set without slides комплексция без направляющих	600	pełny full полное	szary gray серый	stal, tworzywo steel, plastic сталь, пластмасса	
W-WK060-GX-60	na prowadnicy kulkowej H45 on ball bearing slide H45 на шариковой направляющей H45					560-568
W-WK060-VE-60	na prowadnicy kulkowej H45 z funkcją cichego zamknięcia on ball bearing slide H45 with soft closing на шариковой направляющей H45 с доводчиком					
W-WK070-BP-60	komplet bez prowadnic set without slides комплексция без направляющих	700	pełny full полное	szary gray серый	stal, tworzywo steel, plastic сталь, пластмасса	
W-WK070-GX-60	na prowadnicy kulkowej H45 on ball bearing slide H45 на шариковой направляющей H45					660-668
W-WK070-VE-60	na prowadnicy kulkowej H45 z funkcją cichego zamknięcia on ball bearing slide H45 with soft closing на шариковой направляющей H45 с доводчиком					
W-WK080-BP-60	komplet bez prowadnic set without slides комплексция без направляющих	800	pełny full полное	szary gray серый	stal, tworzywo steel, plastic сталь, пластмасса	
W-WK080-GX-60	na prowadnicy kulkowej H45 on ball bearing slide H45 на шариковой направляющей H45					760-768
W-WK080-VE-60	na prowadnicy kulkowej H45 z funkcją cichego zamknięcia on ball bearing slide H45 with soft closing на шариковой направляющей H45 с доводчиком					
W-WK090-BP-60	komplet bez prowadnic set without slides комплексция без направляющих	900	pełny full полное	szary gray серый	stal, tworzywo steel, plastic сталь, пластмасса	
W-WK090-GX-60	na prowadnicy kulkowej H45 on ball bearing slide H45 на шариковой направляющей H45					860-868
W-WK090-VE-60	na prowadnicy kulkowej H45 z funkcją cichego zamknięcia on ball bearing slide H45 with soft closing на шариковой направляющей H45 с доводчиком					



Kosz dwupoziomowy na obuwie
Two tier pull out shoes rack
Двухуровневая корзина для обуви

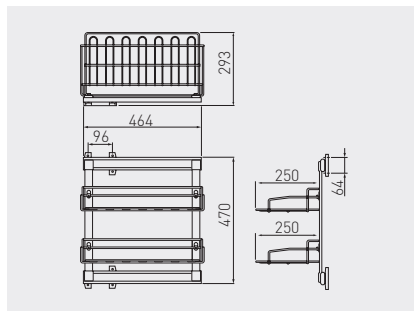

PP-20BUW0-05	lewy / prawy left / right левый / правый	niepełny partial неполное	chrom, aluminium, czarny chrome, aluminium, black хром, алюминий, чёрный	stal, aluminium, tworzywo steel, aluminium, plastic сталь, алюминий, пластмасса
--------------	--	---------------------------------	--	---



Kosz dwupoziomowy
Two tier wardrobe basket
Двухуровневая корзина

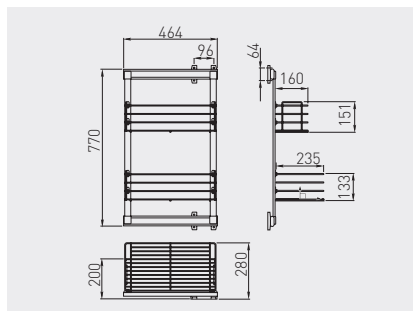

WW-2KOSZ0-05	lewy / prawy left / right левый / правый	niepełny partial неполное	chrom, aluminium, czarny chrome, aluminium, black хром, алюминий, чёрный	stal, aluminium, tworzywo steel, aluminium, plastic сталь, алюминий, пластмасса
--------------	--	---------------------------------	--	---



Szuflada na obuwie
Pull out shoes rack
Полка для обуви

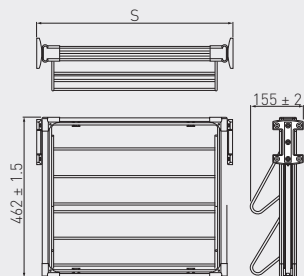

niepełny wysuw / partial extension / неполное выдвижение

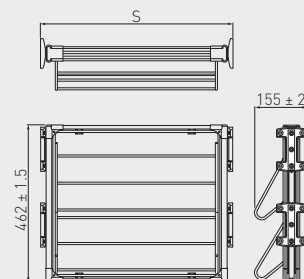

pełny wysuw / full extension / полное выдвижение

			S min/max			
PP-OB UW60-05		niepełny partial неполное	560-581	chrom chrome хром	chrom, aluminium, czarny chrome, aluminium, black хром, алюминий, чёрный	stal, aluminium, tworzywo steel, aluminium, plastic сталь, алюминий, пластмасса
PP-OB UW70-05	660-681					
PP-OB UW80-05	760-781					
PP-OB UW90-05	860-861					
PP-OB UW60-PW		pełny full полное	564-585			
PP-OB UW70-PW	664-685					
PP-OB UW80-PW	764-785					
PP-OB UW90-PW	864-885					



Kosz do szaf
 Wardrobe basket
 Корзина для шкафа

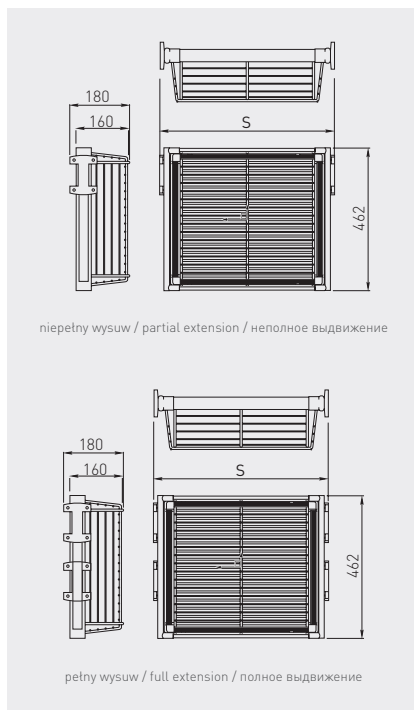

		 S min/max		
WW-KOSZ60-05		560-581	chrom, aluminium, czarny chrome, aluminium, black хром, алюминий, чёрный	stal, aluminium, tworzywo steel, aluminium, plastic сталь, алюминий, пластмасса
WW-KOSZ70-05	niepełny partial неполное	660-681		
WW-KOSZ80-05		760-781		
WW-KOSZ90-05		860-881		
WW-KOSZ60-PW	pełny full полное	564-585		
WW-KOSZ70-PW		664-685		
WW-KOSZ80-PW		764-785		
WW-KOSZ90-PW		864-885		



Wieszak na spodnie
Wardrobe trouser rack
Вешалка для брюк

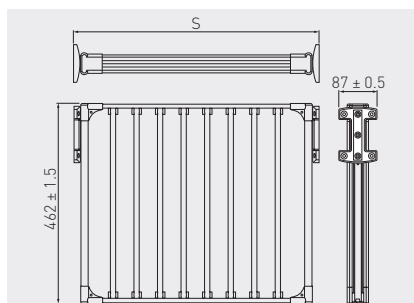

niepełny wysuw / partial extension / неполное выдвижение

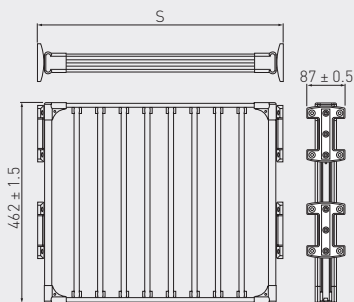









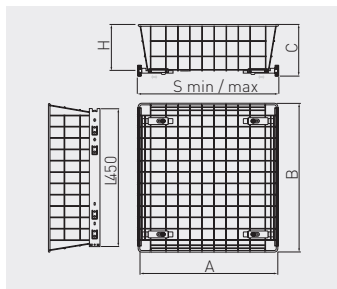







pełny wysuw / full extension / полное выдвижение

			S min/max		
WW-WSP060-05			560-581	chrom, aluminium, czarny chrome, aluminium, black хром, алюминий, чёрный	
WW-WSP070-05	niepełny partial неполное		660-681		
WW-WSP080-05			760-781		
WW-WSP090-05			860-881		
WW-WSP060-PW	pełny full полное		564-585		stal, aluminium, tworzywo steel, aluminium, plastic сталь, алюминий, пластмасса
WW-WSP070-PW			664-685		
WW-WSP080-PW			764-785		
WW-WSP090-PW			864-885		



Kosz na prowadnicy kulkowej H35
 Wardrobe basket on a H35 ball bearing slide
 Корзина на шариковых направляющих H35









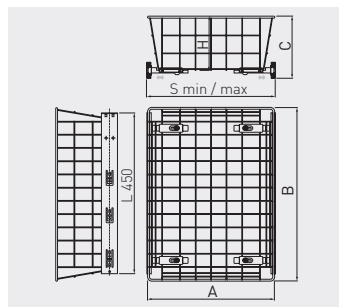



		 mm	 mm	 mm	 mm	 mm	 min/max				
KO-SRH35100-30-10		300	100	255	485	68	260-285				
KO-SRH35100-40-10		400	100	355	485	68	360-385				
KO-SRH35100-50-10		500	100	455	485	68	460-485				
KO-SRH35100-60-10		600	100	555	485	68	560-585				
KO-SRH35150-30-10		300	150	255	485	118	260-285				
KO-SRH35150-40-10		400	150	355	485	118	360-385				
KO-SRH35150-50-10		500	150	455	485	118	460-485				
KO-SRH35150-60-10		600	150	555	485	118	560-585				
KO-SRH35200-30-10		300	200	255	485	168	260-285				
KO-SRH35200-40-10		400	200	355	485	168	360-385				
KO-SRH35200-50-10		500	200	455	485	168	460-485				
KO-SRH35200-60-10		600	200	555	485	168	560-585				
KO-SRH35100-30-OC		300	100	255	485	68	260-285			ocynk galvanized гальваника	
KO-SRH35100-40-OC		400	100	355	485	68	360-385				
KO-SRH35100-50-OC		500	100	455	485	68	460-485				
KO-SRH35100-60-OC		600	100	555	485	68	560-585				
KO-SRH35150-30-OC		300	150	255	485	118	260-285				
KO-SRH35150-40-OC		400	150	355	485	118	360-385				
KO-SRH35150-50-OC		500	150	455	485	118	460-485				
KO-SRH35150-60-OC		600	150	555	485	118	560-585				
KO-SRH35200-30-OC		300	200	255	485	168	260-285				
KO-SRH35200-40-OC		400	200	355	485	168	360-385				
KO-SRH35200-50-OC		500	200	455	485	168	460-485				
KO-SRH35200-60-OC		600	200	555	485	168	560-585				
								srebrny silver серебристый			



Kosz na prowadnicy kulkowej H45 ze spowalniaczem
 Wardrobe basket on a H45 adjustable ball bearing slide
 Корзина на шариковых направляющих H45



		 mm	 mm	 mm	 mm	 mm	 S min/max			
KO-SRH4550-30-10		300	50	255	485	73	260-285			
KO-SRH4550-40-10		400	50	355	485	73	360-385			
KO-SRH4550-50-10		500	50	455	485	73	460-485			
KO-SRH4550-60-10		600	50	555	485	73	560-585			
KO-SRH45100-30-10		300	100	255	485	123	260-285			
KO-SRH45100-40-10		400	100	355	485	123	360-385			
KO-SRH45100-50-10		500	100	455	485	123	460-485			
KO-SRH45100-60-10		600	100	555	485	123	560-585			
KO-SRH45150-30-10		300	150	255	485	173	260-285			
KO-SRH45150-40-10		400	150	355	485	173	360-385			
KO-SRH45150-50-10		500	150	455	485	173	460-485			
KO-SRH45150-60-10		600	150	555	485	173	560-585			
KO-SRH45200-30-10		300	200	255	485	223	260-285			
KO-SRH45200-40-10		400	200	355	485	223	360-385			
KO-SRH45200-50-10		500	200	455	485	223	460-485			
KO-SRH45200-60-10		600	200	555	485	223	560-585			
KO-SRH4550-30-OC		300	50	255	485	73	260-285			
KO-SRH4550-40-OC		400	50	355	485	73	360-385			
KO-SRH4550-50-OC		500	50	455	485	73	460-485			
KO-SRH4550-60-OC		600	50	555	485	73	560-585			
KO-SRH45100-30-OC		300	100	255	485	123	260-285			
KO-SRH45100-40-OC		400	100	355	485	123	360-385			
KO-SRH45100-50-OC		500	100	455	485	123	460-485			
KO-SRH45100-60-OC		600	100	555	485	123	560-585			
KO-SRH45150-30-OC		300	150	255	485	173	260-285			
KO-SRH45150-40-OC		400	150	355	485	173	360-385			
KO-SRH45150-50-OC		500	150	455	485	173	460-485			
KO-SRH45150-60-OC		600	150	555	485	173	560-585			
KO-SRH45200-30-OC		300	200	255	485	223	260-285			
KO-SRH45200-40-OC		400	200	355	485	223	360-385			
KO-SRH45200-50-OC		500	200	455	485	223	460-485			
KO-SRH45200-60-OC		600	200	555	485	223	560-585			

ocynk
galvanized
гальваніка

biały
white
белый

srebrny
silver
серебристый

stal
steel
сталь









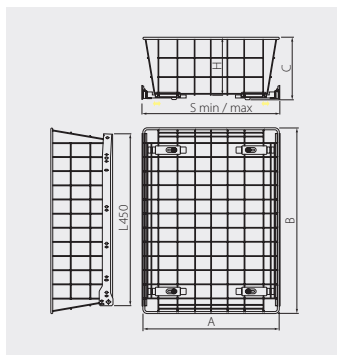

Kosz na prowadnicy rolkowej L = 450

Wardrobe basket on a L = 450 slide

Корзина на роликовых направляющих L = 450



		 H mm	 A mm	 B mm	 C mm	 S min/max				
KO-SRPR100-30-10		300	100	255	485	123	260-285	осунк galvanized гальваника	biały white белый	stal tworzywo
KO-SRPR100-40-10		400	100	355	485	123	360-385			
KO-SRPR100-50-10		500	100	455	485	123	460-485			
KO-SRPR100-60-10		600	100	555	485	123	560-585			
KO-SRPR150-30-10		300	150	255	485	173	260-285			
KO-SRPR150-40-10		400	150	355	485	173	360-385			
KO-SRPR150-50-10		500	150	455	485	173	460-485			
KO-SRPR150-60-10		600	150	555	485	173	560-585			
KO-SRPR200-30-10		300	200	255	485	223	260-285			
KO-SRPR200-40-10		400	200	355	485	223	360-385			
KO-SRPR200-50-10		500	200	455	485	223	460-485			
KO-SRPR200-60-10		600	200	555	485	223	560-585			
KO-SRPR150-30-0C		300	150	255	485	123	260-285		srebrny silver серебристый	stal plastica
KO-SRPR100-40-0C		400	100	355	485	123	360-385			
KO-SRPR100-30-0C		300	100	455	485	123	460-485			
KO-SRPR100-50-0C		500	100	555	485	123	560-585			
KO-SRPR100-60-0C		600	100	255	485	173	260-285			
KO-SRPR150-40-0C		400	150	355	485	173	360-385			
KO-SRPR150-50-0C		500	150	455	485	173	460-485			
KO-SRPR150-60-0C		600	150	555	485	173	560-585			
KO-SRPR200-30-0C		300	200	255	485	223	260-285			
KO-SRPR200-40-0C		400	200	355	485	223	360-385			
KO-SRPR200-50-0C		500	200	455	485	223	460-485			
KO-SRPR200-60-0C		600	200	555	485	223	560-585			



Wieszak na spodnie podwieszany
Wardrobe pull-out trouser rack
Вешалка для брюк подвесная

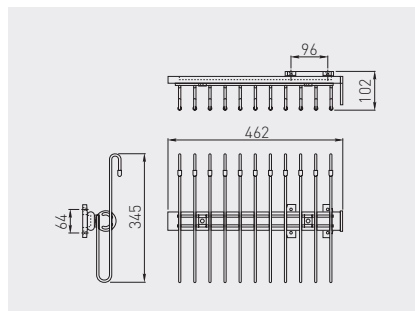

WW-WSP00-01	niepełny partial неполное	chrom, aluminium, czarny chrome, aluminium, black хром, алюминий, чёрный	stal, aluminium, tworzywo steel, aluminium, plastic сталь, алюминий, пластмасса
-------------	---------------------------------	--	---



Wieszak WS na spodnie
Trouser rack WS
Вешалка WS для брюк

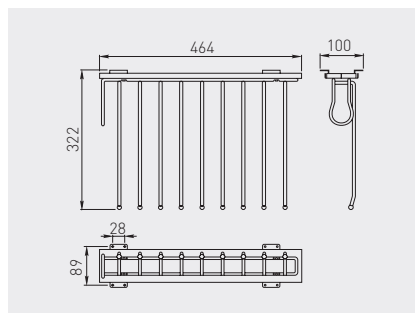





WW-WSP00-01	prawy right правый	niepełny partial неполное	chrom, aluminium, czarny chrome, aluminium, black хром, алюминий, чёрный	stal, aluminium, tworzywo steel, aluminium, plastic сталь, алюминий, пластмасса
WW-WSL00-01	lewy left левый			

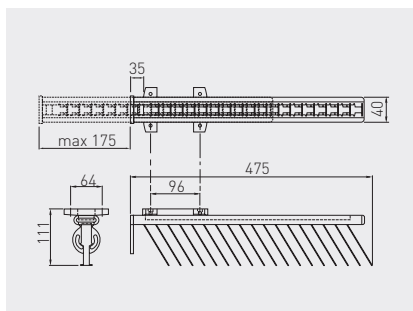

Wieszak KRA na krawaty
 Tie hanger KRA
 Подвеска для галстуков KRA



				
WW-KRAW00-20	lewy / prawy left / right левый / правый	niepełny partial неполное	chrom, aluminium, czarny chrome, aluminium, black хром, алюминий, чёрный	stal, aluminium, tworzywo steel, aluminium, plastic сталь, алюминий, пластмасса



Wieszak KJ na krawaty
 Tie hanger KJ
 Подвеска для галстуков KJ

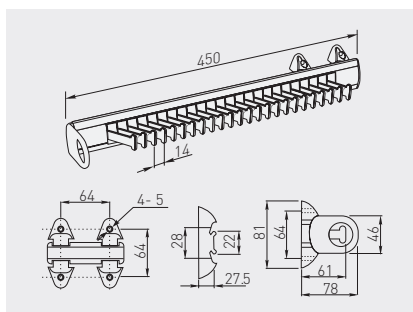

				
WW-KJ0101-01	lewy / prawy left / right левый / правый	niepełny partial неполное	aluminium, czarny aluminium, black алюминий, чёрный	stal, aluminium, tworzywo steel, aluminium, plastic сталь, алюминий, пластмасса



Wieszak KJ na paski
 Belt rack KJ
 Вешалка KJ для ремней

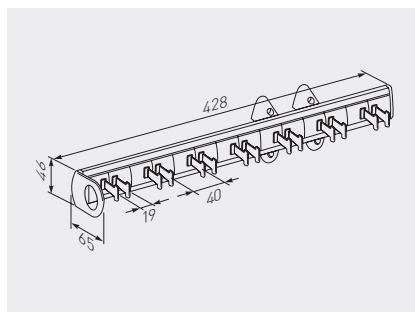





				
WW-KJ0201-01	lewy / prawy left / right левый / правый	niepełny partial неполное	aluminium, czarny aluminium, black алюминий, чёрный	stal, aluminium, tworzywo steel, aluminium, plastic сталь, алюминий, пластмасса

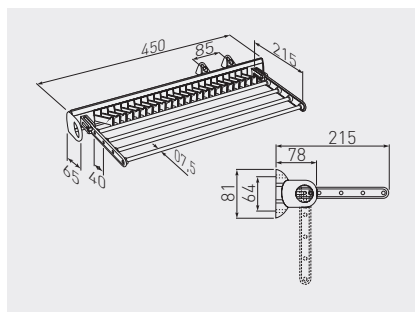

Wieszak J03 na krawaty i spodnie
 Trouser and tie hanger J03
 Вешалка J03 для брюк и галстуков



				
WW-K0AJ03-01	lewy / prawy left / right левый / правый	niepełny partial неполное	chrom, aluminium, czarny chrome +aluminium, black хром, алюминий, чёрный	stal, aluminium, tworzywo steel, aluminium, plastic сталь, алюминий, пластмасса



Wieszak na spodnie składany
 Foldable trouser rack
 Вешалка для брюк, складная

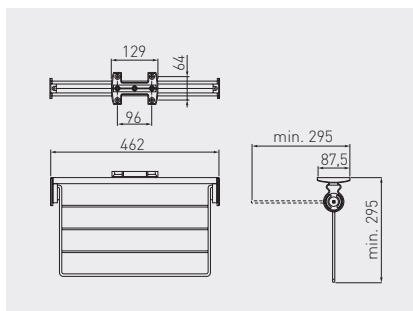

WW-SPODN0-05	lewy / prawy left / right левый / правый	niepełny partial неполное	chrom, aluminium, czarny chrome, aluminium, black хром, алюминий, чёрный	stal, aluminium, tworzywo steel, aluminium, plastic сталь, алюминий, пластмасса



Wieszak J03 na spodnie
 Trouser rack J03
 Вешалка J03 для брюк

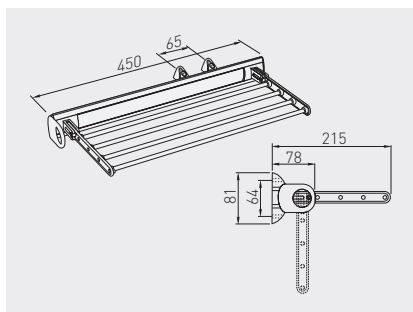

WW-K00J03-01	lewy / prawy left / right левый / правый	niepełny partial неполное	aluminium, czarny aluminium, black алюминий, чёрный	aluminium, tworzywo aluminium, plastic алюминий, пластмасса



Wieszak J04 na krawaty i spodnie
 Trouser and tie rack J04
 Вешалка J04 для брюк и галстуков

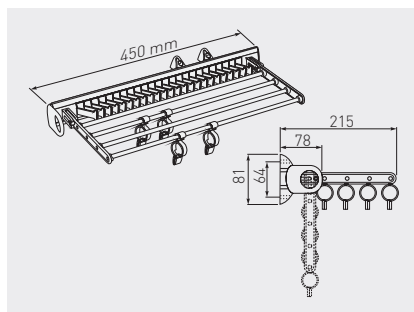
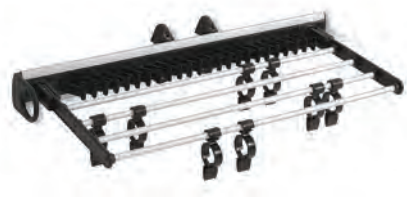

WW-K0AJ04-01	lewy / prawy left / right левый / правый	niepety partial неполное	aluminium, czarny aluminium, black алюминий, чёрный	stal, aluminium, tworzywo steel, aluminium, plastic сталь, алюминий, пластмасса



Wieszak WU na ubrania
 Clothes hanger WU
 Вешалка WU для одежды

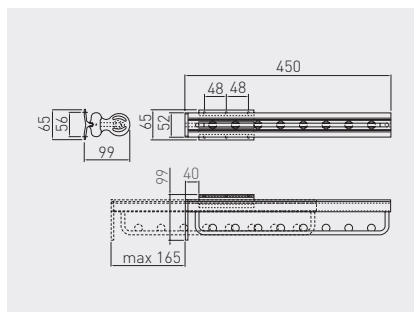





WW-WUBR00-01	niepety partial неполное	chrom, aluminium, czarny chrome, aluminium, black хром, алюминий, чёрный	stal, aluminium, tworzywo steel, aluminium, plastic сталь, алюминий, пластмасса

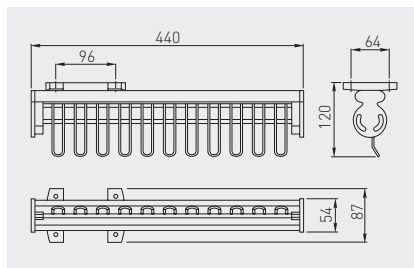

Wieszak K0 na paski
Hanger for belts K0
Вешалка K0 для ремней



				
WW-PASEK0-05	lewy / prawy left / right левый / правый	niepetyny partial неполное	chrom, aluminium, czarny chrome, aluminium, black хром, алюминий, чёрный	stal, aluminium, tworzywo steel, aluminium, plastic сталь, алюминий, пластмасса



Wieszak SE
Hanger SE
Вешалка SE

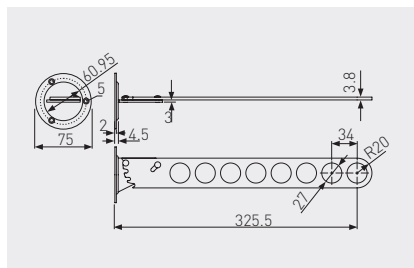





		
WW-SE0102-01	chrom chrome хром	stal steel сталь

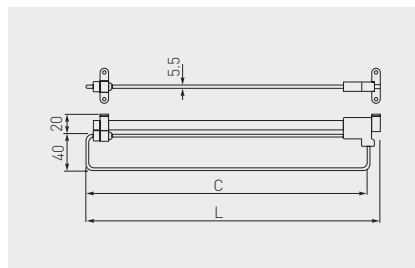

Wieszak WSL Hanger WSL Вешалка WSL





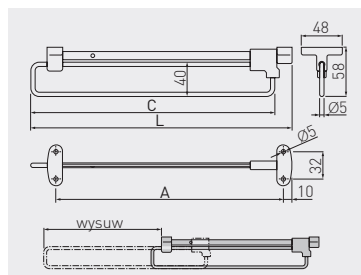

		 C mm	 L mm		
WW-WSL250-01		235	250	chrom chrome хром	stal steel сталь
WW-WSL300-01		285	300		
WW-WSL350-01		335	350		
WW-WSL400-01		385	400		
WW-WSL450-01		435	450		
WW-WSL500-01		485	500		

Wieszak WSL-B wysuwny Retractable hanger WSL-B Выдвижная подвеска WSL-B

NEW





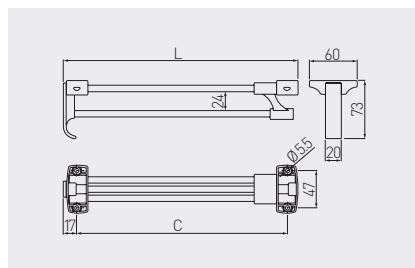

		 C mm	 L mm		
WW-WSL250-01B		235	250	chrom, czarny chrome, black хром, чёрный	stal, tworzywo steel, plastic сталь, пластмасса
WW-WSL300-01B		285	300		
WW-WSL350-01B		335	350		
WW-WSL400-01B		385	400		
WW-WSL450-01B		435	450		
WW-WSL500-01B		485	500		

Wieszak WSD wysuwny
 Retractable hanger WSD
 Выдвижная подвеска WSD





NEW

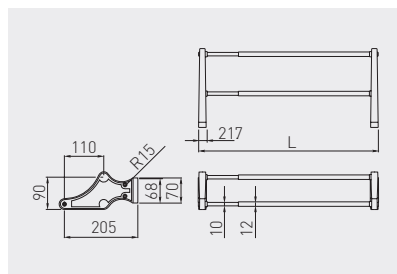

		 C mm	 L mm		
WW-WSD250-01		220	252	chrom, czarny chrome, black хром, чёрный	stal, tworzywo steel, plastic сталь, пластмасса
WW-WSD300-01		270	302		
WW-WSD350-01		320	352		
WW-WSD400-01		370	402		
WW-WSD450-01		420	452		
WW-WSD500-01		470	502		

Półka na obuwie
 Shoe rack
 Полка для обуви



		 L mm		
PP-P04570-20		415 - 700	chrom, aluminium, czarny chrome, aluminium, black хром, алюминий, чёрный	stal, aluminium, tworzywo steel, aluminium, plastic сталь, алюминий, пластмасса
PP-P80110-20		715 - 1100	chrom, czarny chrome, black хром, чёрный	stal, tworzywo steel, plastic сталь, пластмасса



Zawias do półki na obuwie
Hinge for shoe rack
Крепление для полки под обувь

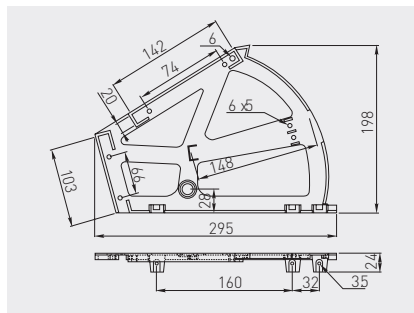

Zastosowanie dla płyty 12 mm
For 12 mm board
Крепление к плите 12 мм



WW-ZWBUT2-10	biały / white / белый	tworzywo plastic пластмасса
WW-ZWBUT2-20	czarny / black / чёрный	



Pantograf z podnośnikiem gazowym
Pull-down wardrobe rail - gas
Пантограф с газовым подъемником

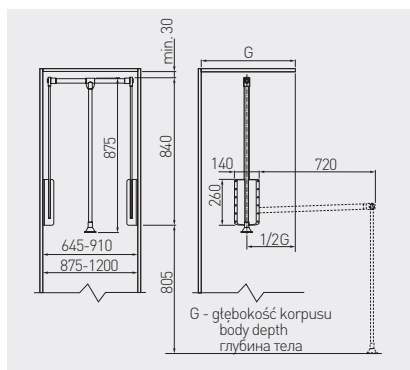





PA-GA4560-10	545 - 700	12	biały / white / белый	stal, tworzywo steel, plastic сталь, пластмасса
PG-GA6083-10	645 - 910			
PA-GA4560-20	545 - 700		czarny / black / чёрный	
PG-GA6083-20	645 - 910			
PG-GA8311520	875 - 1200			

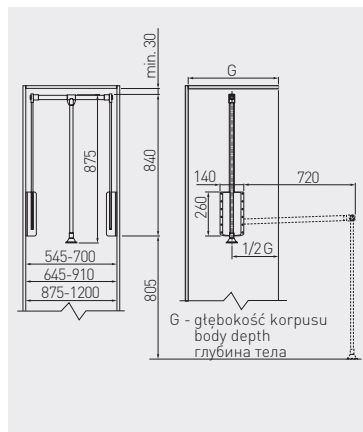

Pantograf z podnośnikiem olejowym
 Pull-down wardrobe rail – oil
 Пантограф с масляным подъемником



	 mm	 kg		
PG-AL4560-20	545 – 700	8	aluminium / aluminium / алюминий	aluminium, tworzywo aluminium, plastic алюминий, пластмасса
PG-AL6083-20	645 – 910			
PG-AL8311520	875 – 1200			
PG-ST4560-10	545 – 700		biały / white / белый	stal, tworzywo steel, plastic сталь, пластмасса
PG-ST4560-20			czarny / black / чёрный	
PG-ST6083-10	645 – 910		biały / white / белый	
PG-ST6083-20			czarny / black / чёрный	
PG-ST83115-10	875 – 1200		biały / white / белый	
PG-ST8311520		czarny / black / чёрный		



Segregator PRACTI ECO 300
 Trash bin PRACTI ECO 300
 Сегрегатор PRACTI ECO 300



PB-45-0010X3



PB-45-002010

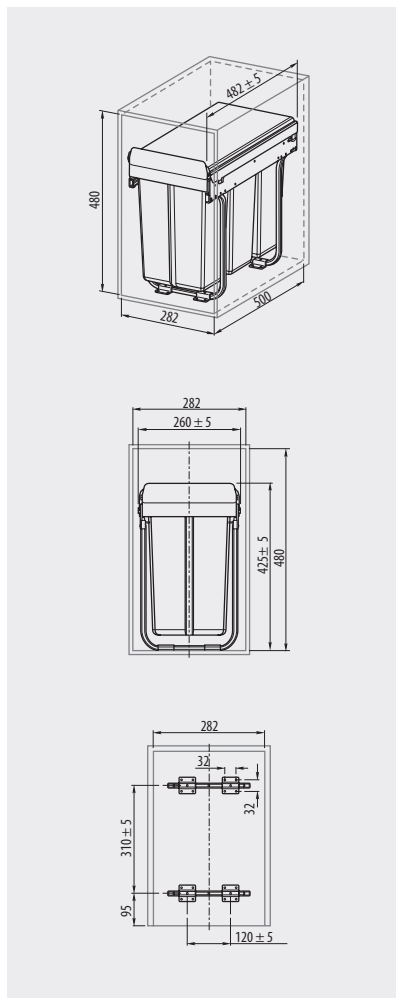

Na prowadnicy kulkowej H45 z cichym domykiem
 On ball bearing slide H45 with soft closing
 На шариковой направляющей H45 с доводчиком



PB-45-0010X3	300	3 x 10 L	szary / gray / серый	tworzywo / plastic / пластмасса
PB-45-002010	300	10 L, 20 L		



Segregator PRACTI ECO 400
 Trash bin PRACTI ECO 400
 Сегрегатор PRACTI ECO 400



PB-45-002X20



PB-45-202X10

Na prowadnicy kulkowej H45 z cichym domykiem
 On ball bearing slide H45 with soft closing
 На шариковой направляющей H45 с доводчиком

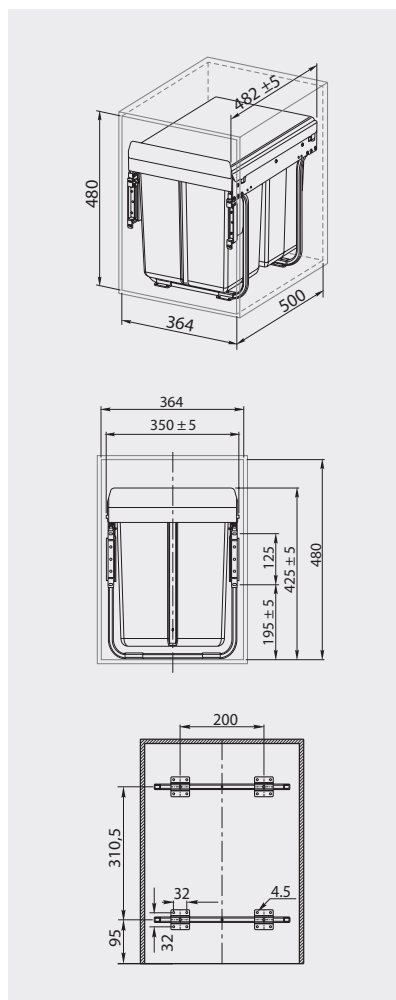

PB-45-002X20	400	2 x 20 L	szary / gray / серый	tworzywo / plastic / пластмасса
PB-45-202X10	400	20 L, 2 x 10 L		



Segregator PRACTI ECO 400 z mocowaniem przednim
 Trash bin PRACTI ECO 400 with door mount bracket
 Сегрегатор PRACTI ECO 400 с передним креплением



PB-45M002S20



PB-45M202S10

Na prowadnicy kulkowej H45 z cichym domykiem
 On ball bearing slide H45 with soft closing
 На шариковой направляющей H45 с доводчиком

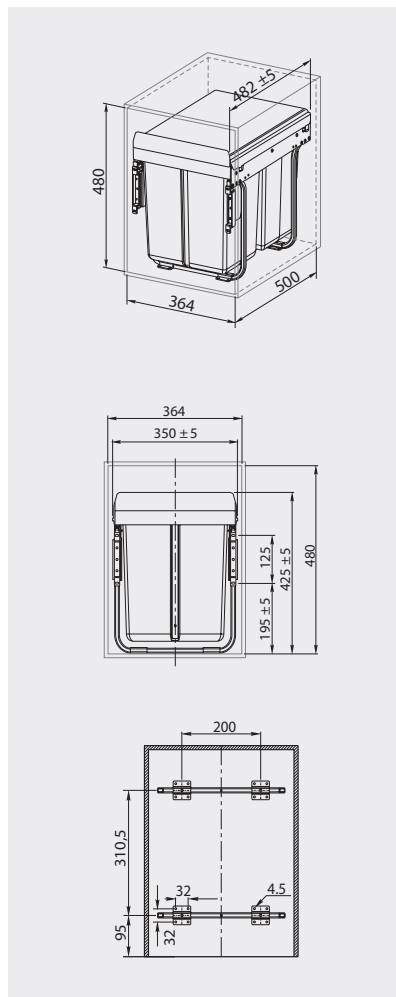

PB-45M002S20	400	2 x 20 L	szary / gray / серый	tworzywo / plastic / пластмасса
PB-45M202S10		20 L, 2 x 10 L		



Segregator PRACTI ECO 450, niski
 Trash bin PRACTI ECO 450, low
 Сегрегатор PRACTI ECO 450, низкий



PB-002X15-60MB

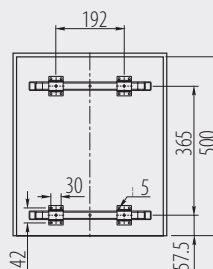
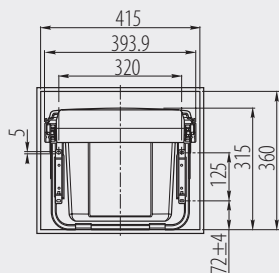
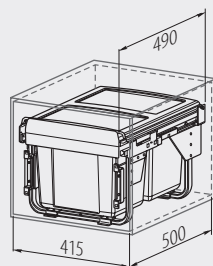

Na prowadnicy z cichym domykiem
 On slide with soft closing
 На направляющей с доводчиком



PB-002X15-60MB

450

2 x 15 L

szary / gray / серый

tworzywo / plastic / пластмасса



Segregator PRACTI ECO 450 niski z mocowaniem przednim
 Trash bin PRACTI ECO 450 low with door mount bracket
 Сегрегатор PRACTI ECO 450 низкий с передним креплением



PB-0M2S15-60MB

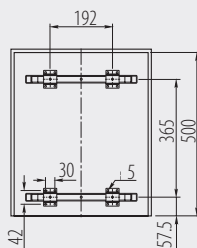
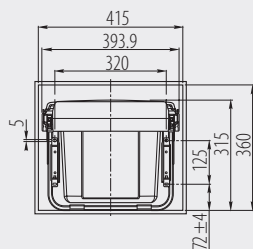
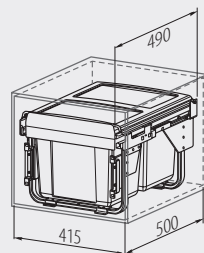

Na prowadnicy z cichym domykiem
 On slide with soft closing
 На направляющей с доводчиком



PB-0M2S15-60MB

450

2 x 15 L

szary / gray / серый

tworzywo / plastic / пластмасса



Segregator PRACTI ECO 450 wysoki
 Trash bin PRACTI ECO 450 high
 Сегрегатор PRACTI ECO 450 высокий



PB-002X20-60MB



PB-020X1060MB

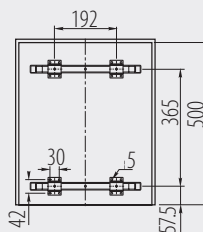
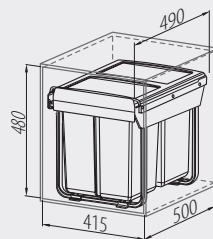
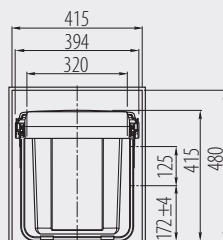

Na prowadnicy z cichym domykiem
 On slide with soft closing
 На направляющей с доводчиком



PB-002X20-60MB	450	2 x 20 L	szary / gray / серый	tworzywo / plastic / пластмасса
PB-020X1060MB		20 L, 2 x 10 L		



Segregator PRACTI ECO 450 wysoki z mocowaniem przednim
 Trash bin PRACTI ECO 450 high with door mount bracket
 Сегрегатор PRACTI ECO 450 высокий с передним креплением



PB-M202X1060MB



PB-0M2S20-60MB

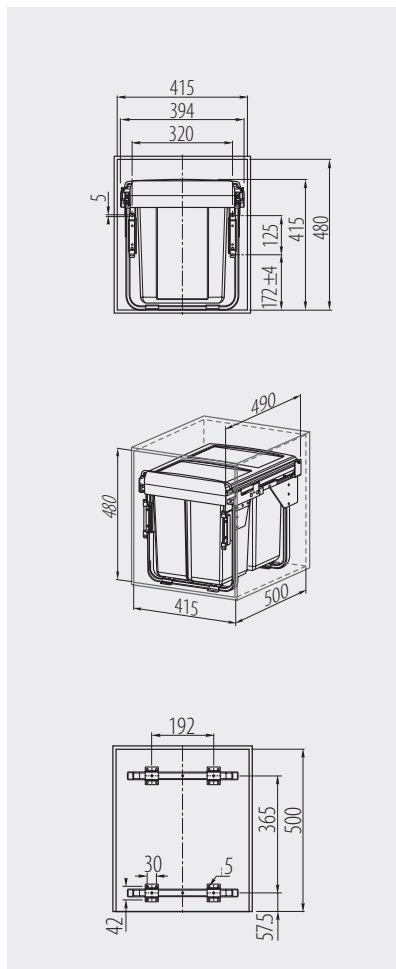

Na prowadnicy z cichym domykiem
 On slide with soft closing
 На направляющей с доводчиком



PB-M202X1060MB	450	20 L, 2 x 10 L	szary / gray / серый	tworzywo / plastic / пластмасса
PB-0M2S20-60MB		2 x 20 L		



Segregator PRACTI ECO 600 wysoki z mocowaniem przednim
 Trash bin PRACTI ECO 600 high with door mount bracket
 Сегрегатор PRACTI ECO 600 высокий с передним креплением



PB-M342X1760MB



PB-0M2X34-60MB

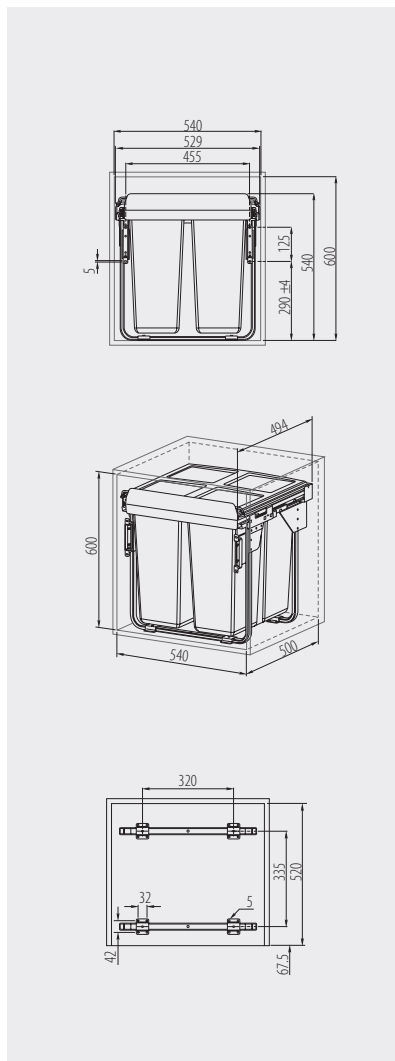

Na prowadnicy z cichym domykiem
 On slide with soft closing
 На направляющей с доводчиком

				
PB-M342X1760MB	600	20 L, 2 x 10 L	szary / gray / серый	tworzywo / plastic / пластмасса
PB-0M2X34-60MB		2 x 20 L		



Kosz QUADRA
Trash bin QUADRA
Мусорная корзина QUADRA

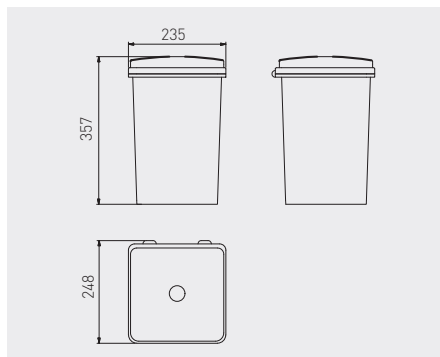

PB-91014100

13 L

szary / gray / серый

tworzywo / plastic / пластмасса



Kosz CIRCA
Trash bin CIRCA
Мусорная корзина CIRCA

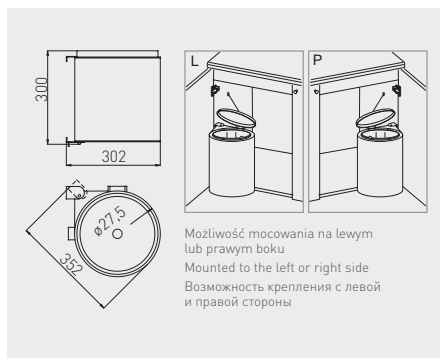

PB-91024160V

11 L

szary / gray / серый

tworzywo / plastic / пластмасса



Kosz ALTOLINO
 Trash bin ALTOLINO
 Мусорная корзина ALTOLINO



Możliwość mocowania na lewym lub prawym boku
 Can be mounted to the left or right side
 Возможность крепления с левой и правой стороны

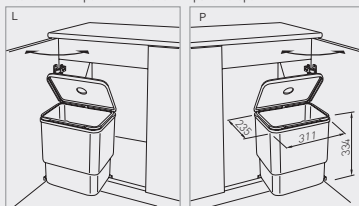

Wymiary montażowe / Mounting dimensions / Монтажные размеры

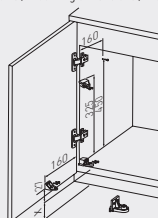

X - odległość od podłogi do górnej krawędzi wieńca
 X - distance from the floor to bottom of cabinet
 X - расстояние между полом и плоскостью дна шкафа

Sposób montażu / Instruction of installation / Способ монтажа

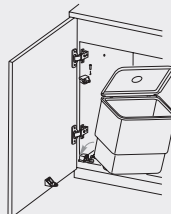

Podwieszenie pokrywy / Suspension cover / Крепление крышки

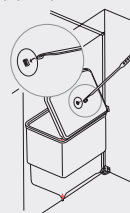

PB-90114100

11 L

szary / gray / серый

tworzywo / plastic / пластмасса



Segregator TIRA 350 plus
 Trash bin TIRA 350 plus
 Сегрегатор TIRA 350 plus

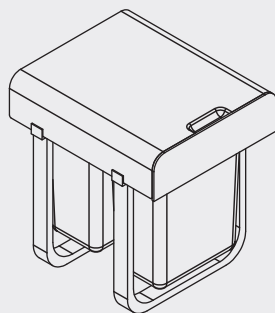
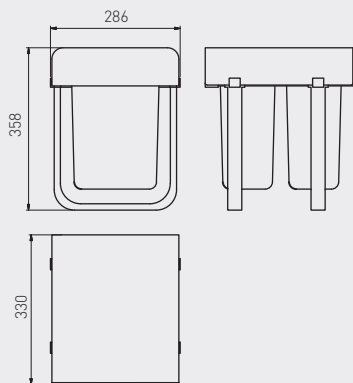

PB-90144100PCT

od 350 / from 350 / от 350

2 x 8 L

szary / gray / серый

tworzywo / plastic / пластмасса



Segregator FORZA 400 plus
 Trash bin FORZA 400 plus
 Сепаратор FORZA 400 plus



PB-90934100PCT



PB-90954100PCT

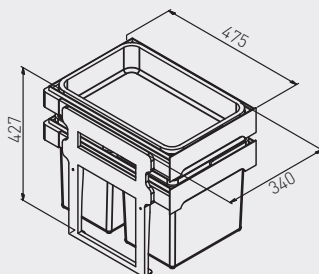
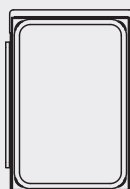
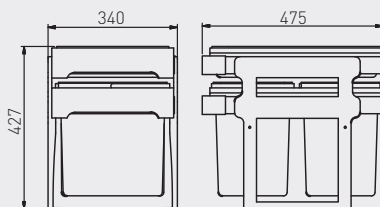

PB-90934100PCT		2 x 16 L		
PB-90954100PCT	od 400 / from 400 / от 400	1 x 16 L, 2 x 8 L	szary / gray / серый	tworzywo / plastic / пластмасса



Segregator FORZA 400 z mocowaniem przednim
 Trash bin FORZA with door mount bracket
 Сегрегатор FORZA с передним креплением



PB-91474100PCT



PB-91464100PCT

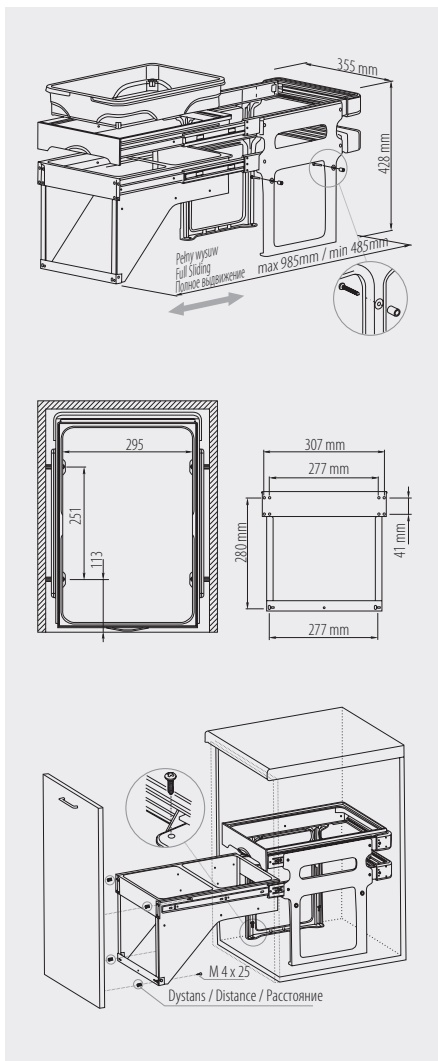

PB-91464100PCT	400	2 x 16 L	szary / gray / серый	tworzywo / plastic / пластмасса
PB-91474100PCT		1 x 16 L, 2 x 8 L		



Segregator UNITO 600
 Trash bin UNITO 600
 Сепаратор UNITO 600

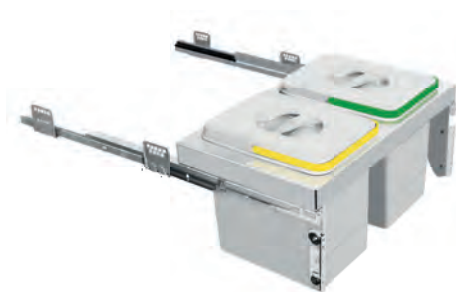



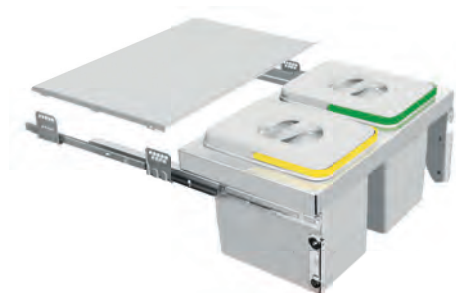

PB-91554160V

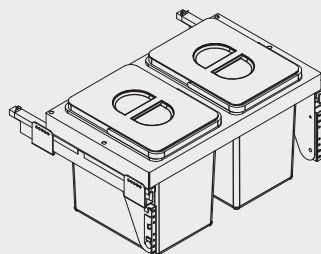
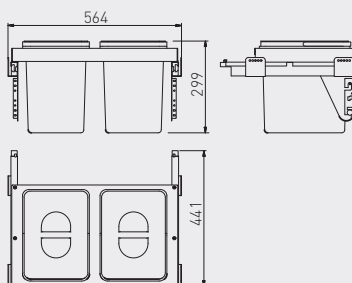

PB-91564160V



Z mocowaniem przednim. Na prowadnicach z cichym domykiem
 With door mount bracket. On ball bearing slides with soft closing
 Крепление к фасаду. Направляющие с доводчиком

	 nmm			
PB-91554160V	600	2 x 15 L	szary gray серый	tworzywo plastic пластмасса
PB-91564160V		2 x 15 L, pokrywka / cover / крышка		



Segregator MULTINO

Trash bin MULTINO

Сегрегатор MULTINO

Przeznaczone do szuflad Modern Box
For Modern Box drawers
Только для ящиков Modern Box



PB-91114100B5



PB-91104100B5



PB-91634100B5

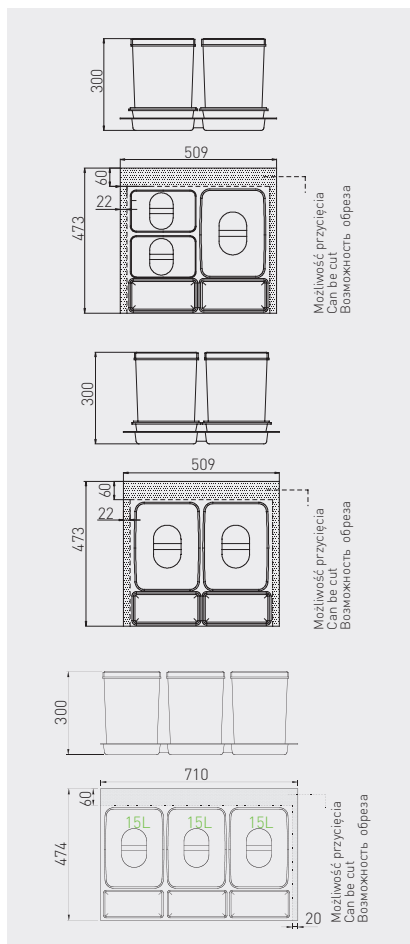

PB-91104100B5	600	2 x 15 L, 2 brytfanki / 3 tray storage spaces / наполнители	szary gray серый	tworzywo plastic пластмасса
PB-91114100B5		1 x 15 L, 2 x 7 L, 2 brytfanki / 3 tray storage spaces / наполнители		
PB-91634100B5	800	3 x 15 L	szary gray серый	tworzywo plastic пластмасса
PB-91644100B5		2 x 15L, 2 x 7 L		
PB-91164100B5	900	3 x 15 L, 3 brytfanki / 3 tray storage spaces / наполнители	szary gray серый	tworzywo plastic пластмасса
PB-91174100B5		2 x 15 L, 2 x 7, 3 brytfanki / 3 tray storage spaces / наполнители		



Segregator MULTINO Trash bin MULTINO Сегрегатор MULTINO

Przeznaczone do szuflad Modern Box
For Modern Box drawers
Только для ящиков Modern Box



PB-91644100B5



PB-91174100B5



PB-91164100B5

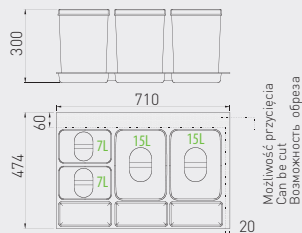

Segregator MULTINO 800 (bez przycinania) jest dopasowany do szuflady MODERN BOX NL=500 zamontowanej w korpusie LW=764*

Without modifications, the MULTINO 800 trash bin is designed to fit MODERN BOX NL=500 drawer, mounted in a cabinet LW=764*

Сегрегатор MULTINO 800 (без обреза) подходит к системе ящиков MODERN BOX NL=500, замонтированной в корпусе LW=764*

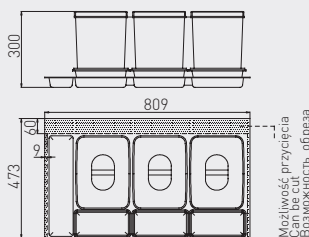
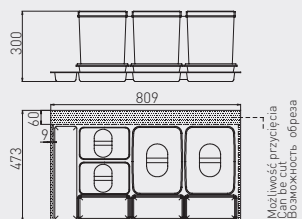

Corner standard Corner standard Выдвижная корзина, стандарт

Cichy domyk, mocowanie do frontu
Soft closing, door mounting bracket
Доводчик, крепление к фасаду

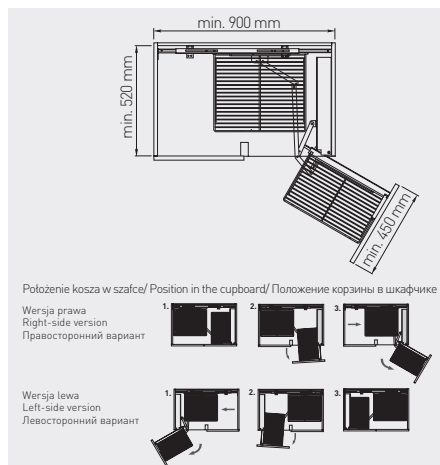
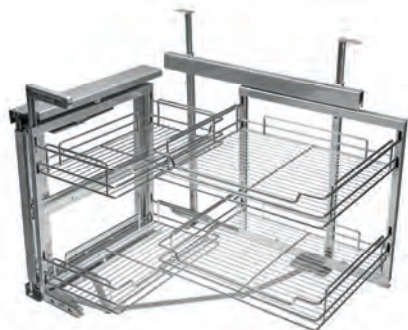

K0-UMC484SC	lewy / prawy left / right левый / правый	40	lakier, chrom lacquer, chrome лак, хром	chrom , srebrny chrome, silver хром, серебристый	stal steel сталь



Corner DUO Corner DUO Корзина DUO

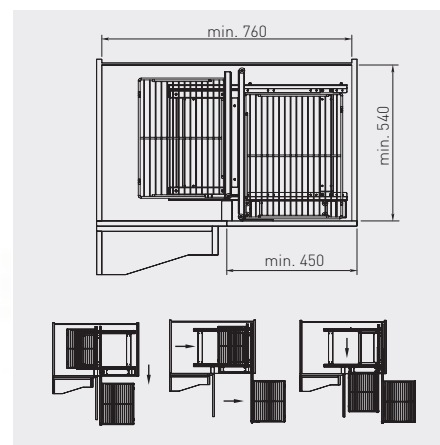





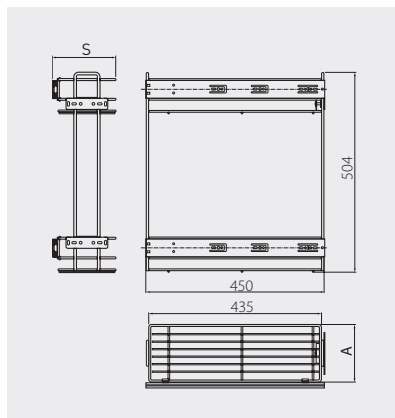

K0-UMC464SC	lewy / prawy left / right левый / правый	40	lakier, chrom lacquer, chrome лак, хром	chrom , srebrny chrome, silver хром, серебристый	stal steel сталь



Cargo boczne na prowadnicy kulkowej H45 ze spowalniczem
 Side cargo on a H45 ball bearing slide with soft closing
 Выдвижная корзина с боковым креплением на шариковых
 направляющих H45 с механизмом плавного закрытия







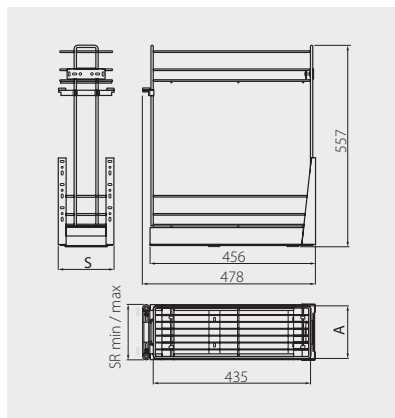

	 mm	 mm	 mm			
KO-1502BO-CR	150	95	110	osynk galvanized гальваника	chrom chrome хром	stal steel сталь
KO-2002BO-CR	200	145	160			
KO-3002BO-CR	300	245	260			
KO-1502BO-10	150	95	110		biaty white белый	
KO-2002BO-10	200	145	160			
KO-3002BO-10	300	245	260			
KO-1502BO-SR	150	95	110		srebrny silver серебристый	
KO-2002BO-SR	200	145	160			
KO-3002BO-SR	300	245	260			



Cargo dolne na prowadnicy kulkowej H45 ze spowalniczem
 CARGO LOWER ball bearing slide H45 with soft close system
 Выдвижная корзина для нижних шкафов на шариковых
 направляющих H45 с механизмом плавного закрытия



	 mm	 mm	 mm			
KO-1502MD-CR	150	95	104	ocynk galvanized гальваника	chrom chrome хром	stal steel сталь
KO-2002MD-CR	200	145	154			
KO-3002MD-CR	300	245	254			
KO-4002MD-CR	400	345	345			
KO-5002MD-CR	500	445	445			
KO-6002MD-CR	600	545	554		srebrny silver серебристый	
KO-1502MD-SR	150	95	104			
KO-2002MD-SR	200	145	154			
KO-3002MD-SR	300	245	254			
KO-4002MD-SR	400	345	345			
KO-5002MD-SR	500	445	445			
KO-6002MD-SR	600	545	554			







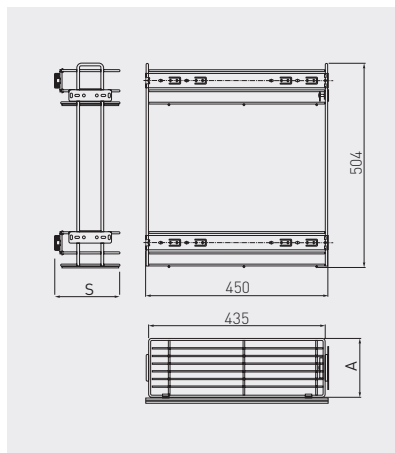

Cargo boczne na prowadnicy kulkowej H35

Side cargo on a H35 ball bearing slide

Выдвижная корзина с боковым креплением на шариковых направляющих H35



	 mm	 mm	 mm			
KO-CMB150-PW-01	150	95	110	ocynk galwanizacja гальваника	chrom chrome хром	stal steel сталь
KO-CMB200-PW-01	200	145	160			
KO-CMB300-PW-01	300	245	260			
KO-CMB150-PW-10	150	95	110		biały white белый	
KO-CMB200-PW-10	200	145	160			
KO-CMB300-PW-10	300	245	260			
KO-CMB150-PW-OC	150	95	110		srebrny silver серебристый	
KO-CMB200-PW-OC	200	145	160			
KO-CMB300-PW-OC	300	245	260			



Ociekarka dwupoziomowa do montażu Two tier dish drying rack Двухуровневая сушилка для посуды (монтаж)



OC-A0150-06		
OC-A0160-06	stal szcztokowana brushed steel шлифованная сталь	stal nierdzewna stainless steel нержавеющая сталь
OC-A0170-06		
OC-A0180-06		
OC-A0190-06		

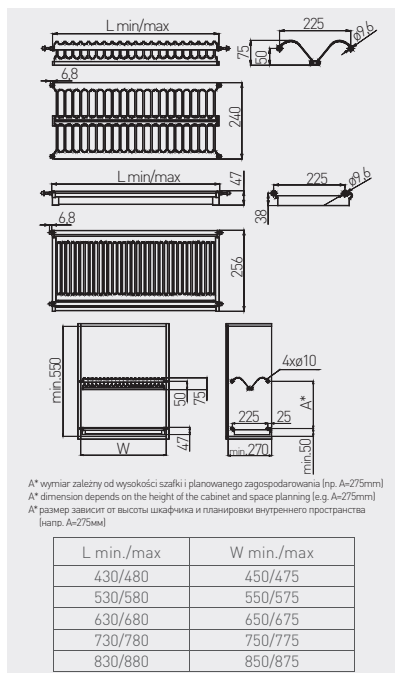

Ociekarka jednopoziomowa do montażu Dish drying rack Сушилка для посуды (монтаж)





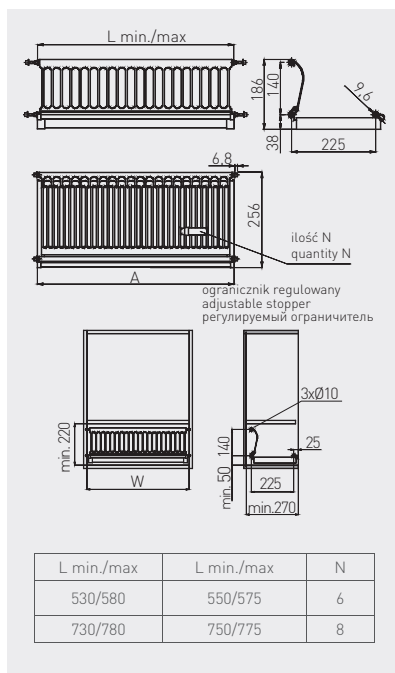

OC-A0660-06	stal szcztokowana brushed steel шлифованная сталь	stal nierdzewna stainless steel нержавеющая сталь
OC-A0680-06		

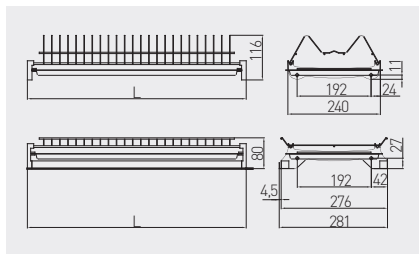
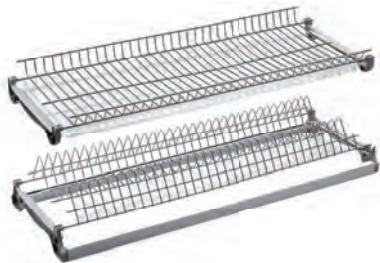

Ociekarka dwupoziomowa do montażu
Two tier dish drying rack
Двухуровневая сушилка для посуды (встраиваемая)



		 L mm		
OC-2PV340-01	do płyty 16 mm for 16 mm board для поверхности 16 мм	368	chrom chrome хром	stal nierdzewna, tworzywo stainless steel, plastic нержавеющая сталь, пластмасса
OC-2PV350-01		468		
OC-2PV360-01		568		
OC-2PV370-01		668		
OC-2PV380-01		768		
OC-2PV390-01	868			
OC-2PV340-01-18	do płyty 18 mm for 18 mm board для поверхности 18 мм	364		
OC-2PV350-01-18		464		
OC-2PV360-01-18		564		
OC-2PV370-01-18		664		
OC-2PV380-01-18		764		
OC-2PV390-01-18		864		



Ociekarka dwupoziomowa A04, wolnostojąca
Two tier dish drying rack A04
Сушилка для посуды настольная A04, двухуровневая

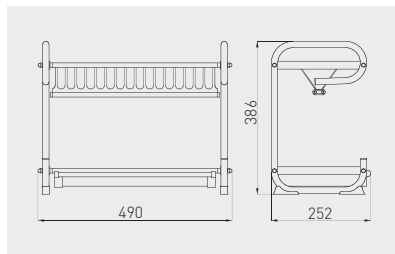

OC-A0450-06



stal szczotkowana
brushed steel
шлифованная сталь



stal nierdzewna
stainless steel
нержавеющая сталь



Ociekarka dwupoziomowa A03, wolnostojąca
Two tier dish drying rack A03
Сушилка для посуды настольная A03, двухуровневая

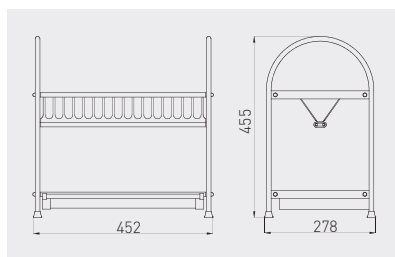

OC-A0350K-06



stal szczotkowana
brushed steel
шлифованная сталь



stal nierdzewna
stainless steel
нержавеющая сталь



Ociekarka dwupoziomowa z organizerem, wolnostojąca
 Two tier dish drying rack with organizer
 Сушилка для посуды и столовых приборов настольная, двухуровневая

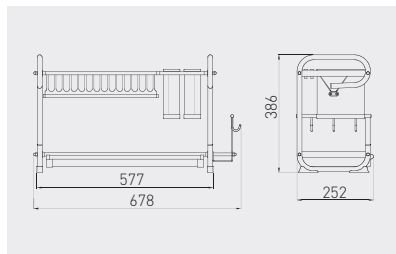

OC-A0460D-06



stal szczotkowana
 brushed steel
 шлифованная сталь



stal nierdzewna
 stainless steel
 нержавеющая сталь



Ociekarka zwijana
 Roll-up drying rack
 Складная сушилка

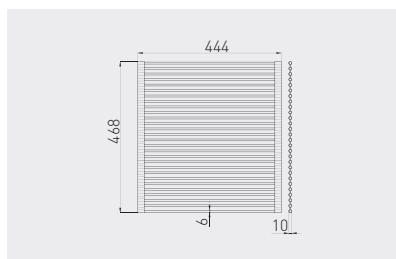
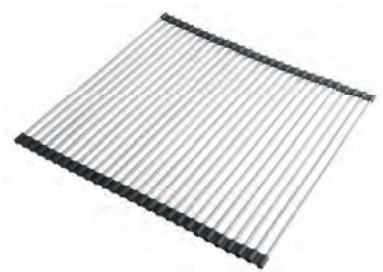

OC-E0707D-CZ



stal szczotkowana, czarny
 brushed steel, black
 шлифованная сталь, чёрный



stal nierdzewna
 stainless steel
 нержавеющая сталь





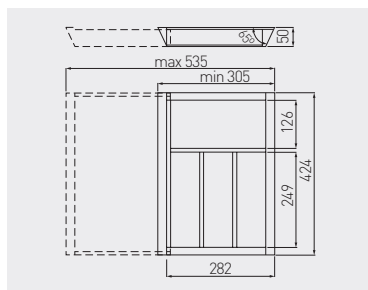

Wkład CUSTOMI A regulowany Adjustable cutlery organizer CUSTOMI A Вкладыш CUSTOMI A с возможностью регулировки



Do szuflad Modern Box i Axis L450
For Modern Box or Axis L=450 mm
Подходит для ящиков Modern Box/Axis L=450 мм

Maksymalny wysuw = 535 mm
Maximum extension = 535 mm
Максимальное выдвижение = 535 мм

				
W-CUSTOMI-60L450	424 x 305	lakier bezbarwny matowy clearcoat matt surface лак матовый бесцветный	buk beech бук	drewno buk beech wood дерево бука



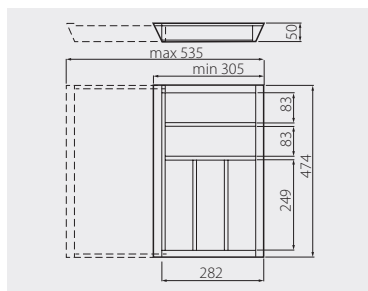

Wkład CUSTOMI BIS A regulowany Adjustable cutlery organizer CUSTOMI BIS A Вкладыш CUSTOMI BIS A с возможностью регулировки



Do szuflad Modern Box i Axis L=500
For Modern Box or Axis L=500 mm
Подходит для ящиков Modern Box/Axis L=500 мм

Maksymalny wysuw = 535 mm
Maximum extension = 535 mm
Максимальное выдвижение = 535 мм

				
W-CUSTOMI-60L500	474 x 305	lakier bezbarwny matowy clearcoat matt surface лак матовый бесцветный	buk beech бук	drewno buk beech wood дерево бука





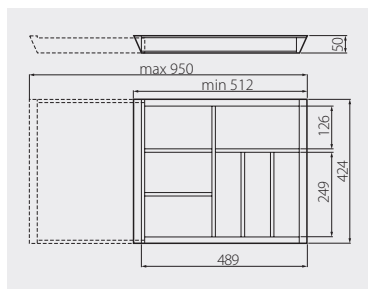

Wkład CUSTOMI B regulowany
Adjustable cutlery organizer CUSTOMI B
Вкладыш CUSTOMI B с возможностью регулировки



Do szuflad Modern Box i Axis L=450
For Modern Box or Axis L=450 mm
Подходит для ящиков Modern Box/Axis L=450 мм

Maksymalny wysuw = 950 mm
Maximum extension = 950 mm
Максимальное выдвижение = 950 мм

				
W-CUSTOMI-80L450	512 x 424 mm	lakier bezbarwny matowy clearcoat matt surface лак матовый бесцветный	buk beech бук	drewno buk beech wood дерево бука





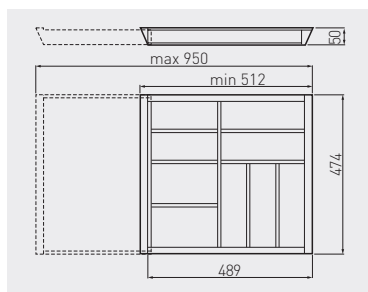

Wkład CUSTOMI BIS B regulowany
Adjustable cutlery organizer CUSTOMI BIS B
Вкладыш CUSTOMI BIS B с возможностью регулировки



Do szuflad Modern Box i Axis L=500
For Modern Box or Axis L=500 mm
Подходит для ящиков Modern Box/Axis L=500 мм

Maksymalny wysuw = 950 mm
Maximum extension = 950 mm
Максимальное выдвижение = 950 мм





				
W-CUSTOMI-80L500	512 x 474 mm	lakier bezbarwny matowy clearcoat matt surface лак матовый бесцветный	buk beech бук	drewno buk beech wood дерево бука

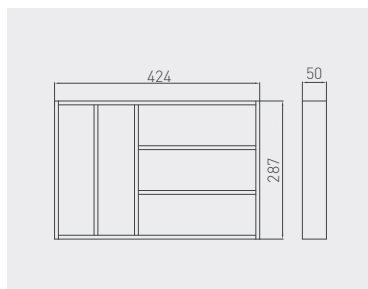

Wkład INSERTI A Cutlery organizer INSERTI A Универсальный вкладыш INSERTI A



Do szuflad Modern Box i Axis L=450
For Modern Box or Axis L=450 mm
Подходит для ящиков Modern Box/Axis L=450 мм





				
W-INSERTI-L450	424 x 287	lakier bezbarwny matowy clearcoat matt surface лак матовый бесцветный	buk beech бук	drewno buk beech wood дерево бука

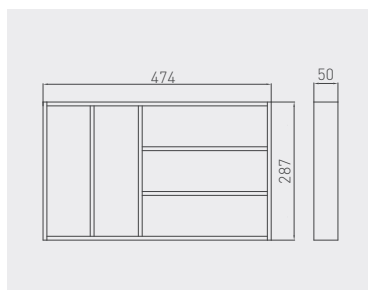

Wkład INSERTI B Cutlery organizer INSERTI B Универсальный вкладыш INSERTI B



Do szuflad Modern Box i Axis L=500
For Modern Box or Axis L=500 mm
Подходит для ящиков Modern Box/Axis L=500 мм

				
W-INSERTI-L500	474 x 287	lakier bezbarwny matowy clearcoat matt surface лак матовый бесцветный	buk beech бук	drewno buk beech wood дерево бука



Blok KNIFI na noże
 Knife block KNIFI
 Вставка KNIFI для ножей

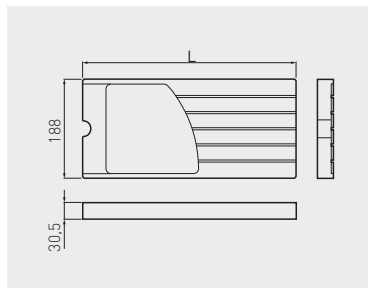

W-AKC-KNIFI-L450	405	lakier bezbarwny matowy clearcoat matt surface лак матовый бесцветный	buk beech бук	drewno buk beech wood дерево бука
W-AKC-KNIFI-L500	455			



Blok HERBI na przyprawę
 Spice tray HERBI
 Вставка HERBI для специй

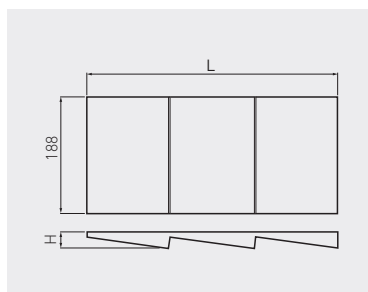

W-AKC-HERBI-L450	405	24	lakier bezbarwny matowy clearcoat matt surface лак матовый бесцветный	buk beech бук	drewno buk beech wood дерево бука
W-AKC-HERBI-L500	455	26			



Uchwyt HOLDI na folię
 Foil roll dispenser HOLDI
 Вставка HOLDI для фольги и пленки

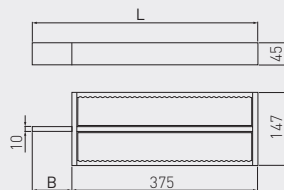

	 mm			
W-AKC-HOLDI-L450	405 x 147	lakier bezbarwny matowy clearcoat matt surface лак матовый бесцветный	buk beech бук	drewno buk beech wood дерево бука
W-AKC-HOLDI-L500	455 x 147			



Mata antypoślizgowa do szuflad
 Anti-slip mat for drawers
 Противоскользящий коврик для ящиков



	 mm		
MA-MATA-0-00	1500 x 470	przeźroczysty transparent прозрачный	tworzywo plastic пластмасса



Półka pod klawiaturę z prowadnicą kulkową 27 mm
 Keyboard shelf with 27 mm drawer slide
 Полка для клавиатуры с шариковой направляющей 27 мм

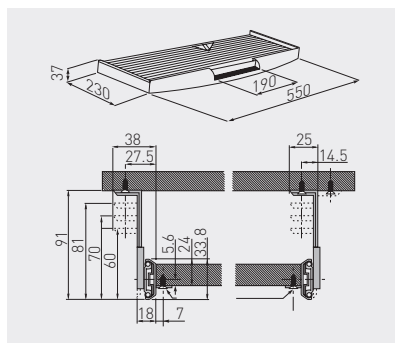

PU-KEY027-20	czarny / black / чёрны	tworzywo plastic пластмасса
PU-KEY027-60	szary / gray / серый	



Półka pod klawiaturę z podkładką na myszkę
 Keyboard shelf with mouse pad
 Полка для клавиатуры с подставкой для мыши

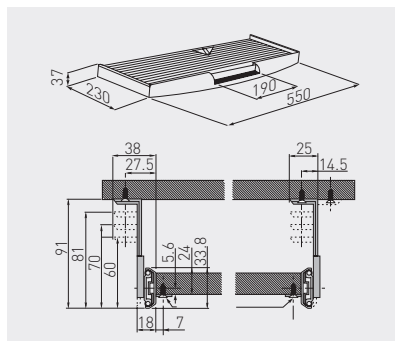

PU-KEYM27-20	czarny / black / чёрны	tworzywo plastic пластмасса
PU-KEYM27-60	szary / gray / серый	



Wózek pod komputer
Computer trolley
Передвижная подставка под компьютер

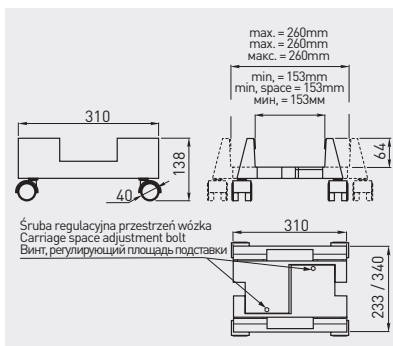

PU-PKO-00-20	czarny / black / чёрны	tworzywo plastic пластмасса
PU-PKO-00-60	szary / gray / серый	



Hub – 4 porty USB
Hub – 4 USB ports
Удлинитель на 4 входа USB

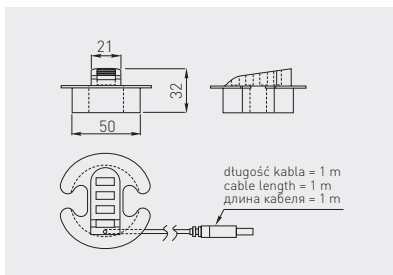

HB-USB-4X-20	czarny / black / чёрный	tworzywo plastic пластмасса
HB-USB-4X-60	srebrny / silver / серебряный	



Przepust MERIDA 80
 Desk cable outlet MERIDA 80
 Пропуск для кабеля MERIDA 80

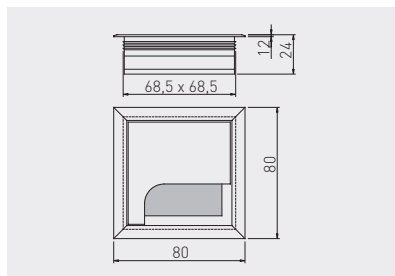





	 mm		
LB-K80X80-05	80 x 80	aluminium / aluminium / алюминий	aluminium
LB-K80X80-20		czarny / black / чёрный	aluminium aluminium алюминий

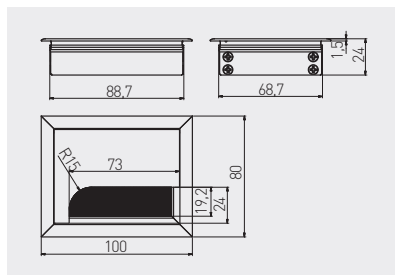

Przepust MERIDA 100
 Desk cable outlet MERIDA 100
 Пропуск для кабеля MERIDA 100







	 mm		
LB-K80X100-05	80 x 100	aluminium / aluminium / алюминий	aluminium
LB-K80X100-20		czarny / black / чёрный	aluminium aluminium алюминий

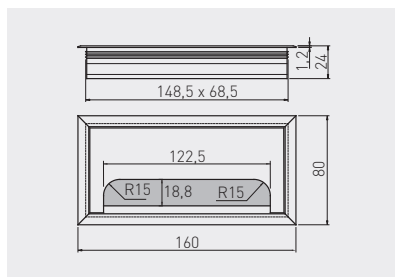

Przepust MERIDA 160
 Desk cable outlet MERIDA 160
 Пропуск для кабеля MERIDA 160







	 mm		
LB-80X160-05	80 x 160	aluminium / aluminium / алюминий	aluminium aluminium алюминий
LB-80X160-20		czarny / black / чёрный	

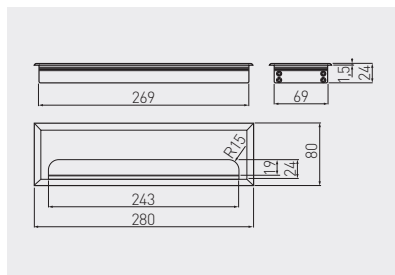

Przepust MERIDA 280
 Desk cable outlet MERIDA 280
 Пропуск для кабеля MERIDA 280



	 mm		
LB-80X280-05	80 x 280	aluminium / aluminium / алюминий	aluminium aluminium алюминий
LB-80X280-20		czarny / black / чёрный	



Przepust MERIDA 500
Desk cable outlet MERIDA 500
Пропуск для кабеля MERIDA 500

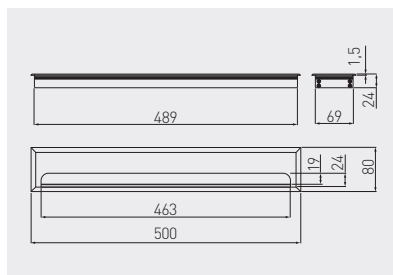

LB-80X500-05	80 x 500	aluminium / aluminium / алюминий	aluminium aluminium алюминий
LB-80X500-20		czarny / black / чёрный	



Przepust LBF
Desk cable grommet LBF
Пропуск для кабеля LBF

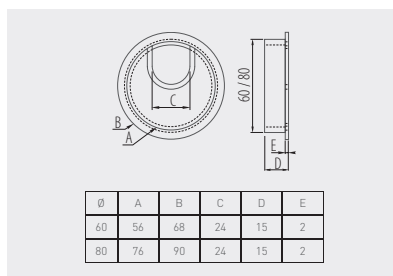

PM-LBF160-01	60	chrom / chrome / хром	ZnAl
PM-LBF160-02		satyna / satin / сатин	
PM-LBF160-05		aluminium / aluminium / алюминий	
PM-LBF160-06		stal szczotkowana / brushed steel / шлифованная сталь	
PM-LBF180-01		chrom / chrome / хром	
PM-LBF180-02		satyna / satin / сатин	
PM-LBF180-05	80	aluminium / aluminium / алюминий	ZnAl
PM-LBF180-06		stal szczotkowana / brushed steel / шлифованная сталь	



Przepust PLF
 Desk cable grommet PLF
 Пропуск для кабеля PLF

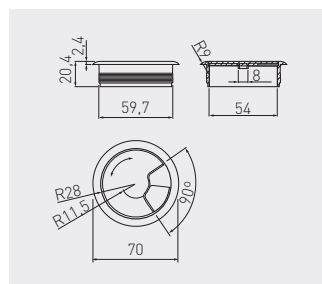



		
PM-PLFI60-02	satyna / satin / сатин	tworzywo plastic пластмасса
PM-PLFI60-05	aluminium / aluminium / алюминий	
PM-PLFI60-10	biały / white / белый	
PM-PLFI60-20	czarny / black / чёрный	
PM-PLFI60-30	popiel / gray / серый	
PM-PLFI60-41	olcha / alder / ольха	
PM-PLFI60-42	grusza / pear / груша	
PM-PLFI60-43	jasny brąz / light brown / светло-коричневый	
PM-PLFI60-44	buk / beech / бук	
PM-PLFI60-45	orzech / walnut / цвет орех	
PM-PLFI60-46	rustikal / rustical / рустикал	
PM-PLFI60-47	buk / beech / бук	
PM-PLFI60-48	mahoń / mahogany / красное дерево	
PM-PLFI60-49	klon / maple / клен	
PM-PLFI60-50	beż / beige / бежевый	
PM-PLFI60-51	kalwados / calvados / кальвадос	
PM-PLFI60-52	wiśnia / cherry / вишня	
PM-PLFI60-58	wenge / venge / венге	

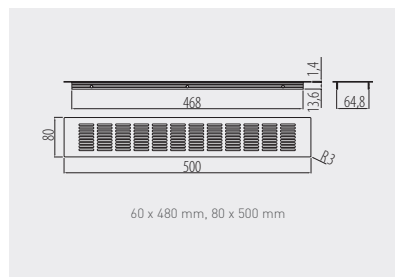

Kratka wentylacyjna D50-80
Plinth vent D50-80
Вентиляционная решётка D50-80







			
KK-D50-80-06	przepustowość powietrza - 108 cm ² air throughput - 108 cm ² прохождение воздушного потока - 108 см ²	stal szorstkowana brushed steel шлифованная сталь	aluminium aluminium алюминий

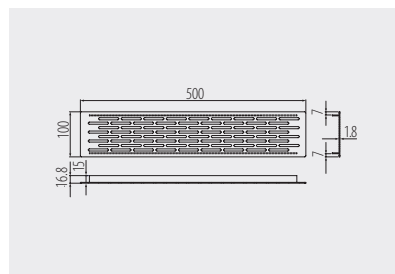
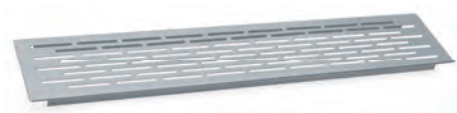

Kratka wentylacyjna D50-100
Plinth vent D50-100
Вентиляционная решётка D50-100



			
KK-D50100-06	przepustowość powietrza - 130 cm ² air throughput - 130 cm ² прохождение воздушного потока - 130 см ²	stal szorstkowana brushed steel шлифованная сталь	aluminium aluminium алюминий



Kratka wentylacyjna W60
Plinth vent W60
Вентиляционная решётка W60

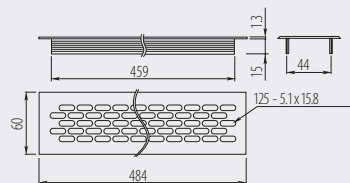

KK-W60800-M0	przepustowość powietrza - 94 cm ² air throughput - 94 cm ²	szary / gray / серый	aluminium aluminium
KK-W60800-M1	прохождение воздушного потока - 94 см ²	biały / white / белый	aluminium алюминий



Kratka wentylacyjna W80
Plinth vent W80
Вентиляционная решётка W80

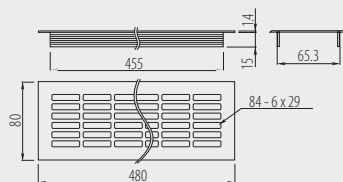
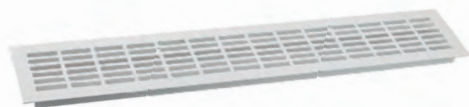

KK-W80800-D0	przepustowość powietrza - 146 cm ² air throughput - 146 cm ²	szary / gray / серый	aluminium aluminium
KK-W80800-D1	прохождение воздушного потока - 146 см ²	biały / white / белый	aluminium алюминий



Obrotnica okrągła
Round swivel bracket
Круглый поворотный кронштейн

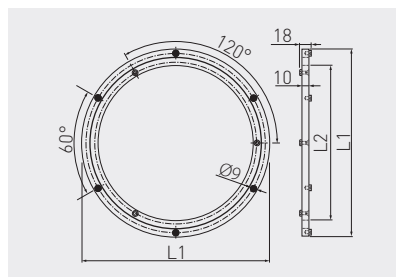

	 L1 mm	 L2 mm	 kg		
OM-OB0300-05	300	248	60	aluminium aluminium алюминий	aluminium aluminium алюминий
OM-OB0350-05	350	298	80		
OM-OB0400-05	400	338	100		



Obrotnica kwadratowa
Square swivel bracket
Поворотный кронштейн, квадратный

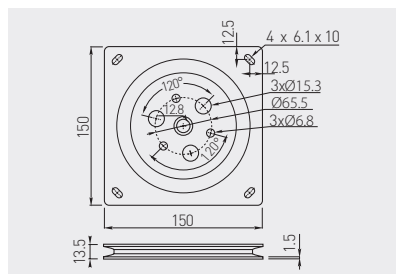

	 kg		
OM-OBK150-20	50	czarny black чёрный	stal steel сталь



**AKCESORIA DEKORACYJNE
DECORATIVE ACCESSORIES
ЛИЦЕВАЯ ФУРНИТУРА**

Uchwyty Handles Ручки	244 – 329
Wieszaki Hooks Крючки	330 – 342
Nóżki meblowe Furniture legs Мебельные ножки	343 – 372
Nogi meblowe Furniture legs Мебельные опоры	373 – 378
Rolki meblowe Furniture castors Мебельные колёсики	379 – 383
Zamki meblowe Cabinet locks Замки	384 – 391

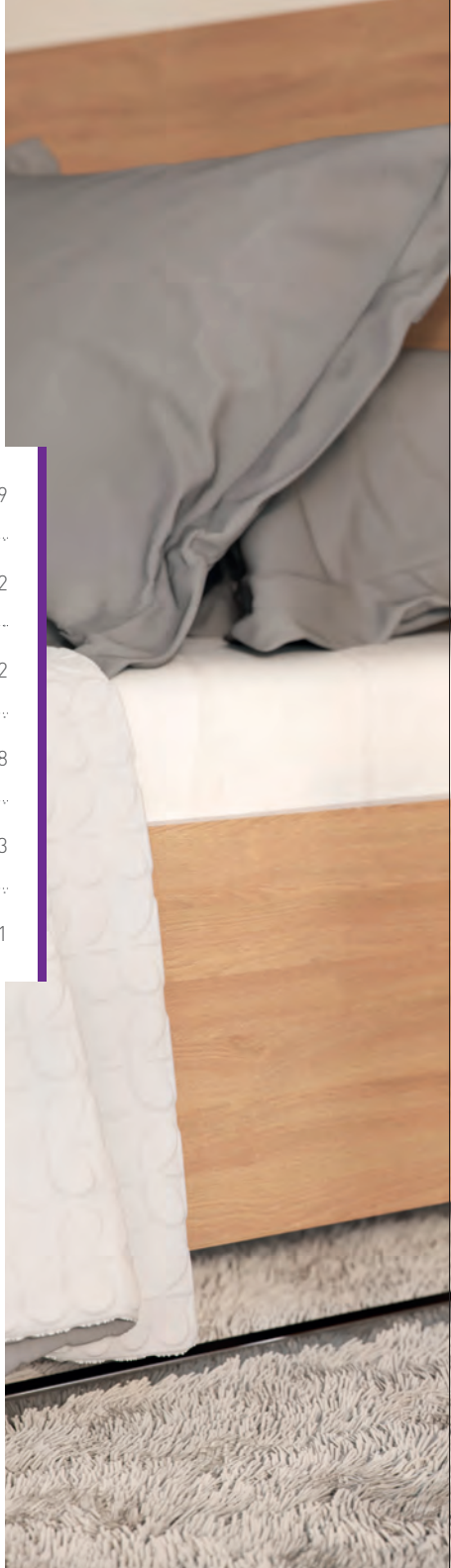



Uchwyt CLEO
Handle CLEO
Ручка CLEO



finalist
of the competition



2017

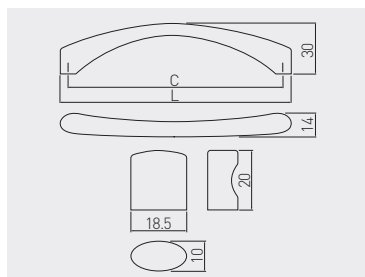

C
mm L
mm



		chrom chrome хром	aluminium aluminium алюминий	stal szorstkowana brushed steel шлифованная сталь	
128	137	UZ-CLEO-128-01	UZ-CLEO-128-05	UZ-CLEO-128-06	ZnAl
160	169	UZ-CLEO-160-01	UZ-CLEO-160-05	UZ-CLEO-160-06	
192	201	UZ-CLEO-192-01	UZ-CLEO-192-05	UZ-CLEO-192-06	
gatka knob ручка		GZ-CLEO-1-01	GZ-CLEO-1-05	GZ-CLEO-1-06	

Uchwyt SENIOR
Handle SENIOR
Ручка SENIOR



DIAMENT
meblarstwa
2016

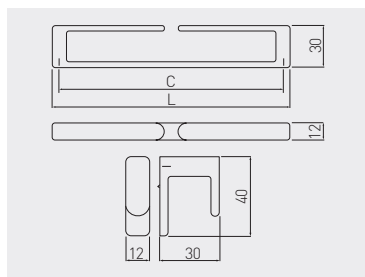
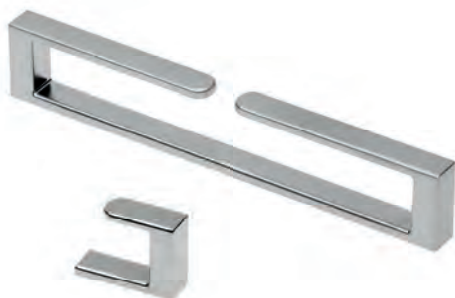

C
mm L
mm



		chrom chrome хром	aluminium aluminium алюминий	
160	170	UZ-SENIOR-160-01	UZ-SENIOR-160-05	ZnAl
gatka knob ручка		GZ-SENIOR-1-01	GZ-SENIOR-1-05	

Uchwyt VETA
Handle VETA
Ручка VETA

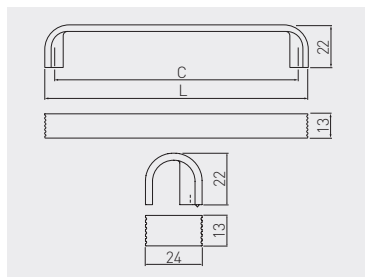

C mm	L mm				
		chrom chrome хром	aluminium aluminium алюминий	czarny chrom black chrome чёрный хром	ZnAl
128	138	UZ-VETA-128-01	UZ-VETA-128-05	UZ-VETA-128-12	
160	170	UZ-VETA-160-01	UZ-VETA-160-05	UZ-VETA-160-12	
320	330	UZ-VETA-320-01	UZ-VETA-320-05	UZ-VETA-320-12	
gatka knob ручка		GZ-VETA-1-01	GZ-VETA-1-05	GZ-VETA-1-12	

Uchwyt GANZA
Handle GANZA
Ручка GANZA

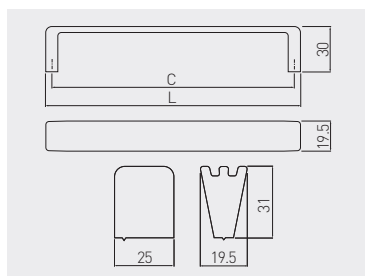

C mm	L mm					
		chrom chrome хром	aluminium aluminium алюминий	biały white белый	czarny chrom black chrome чёрный хром	ZnAl
160	168	UZ-GANZA-160-01	UZ-GANZA-160-05	UZ-GANZA-160-10	UZ-GANZA-160-12	
gatka knob ручка		GZ-GANZA-1-01	GZ-GANZA-1-05	GZ-GANZA-1-10	GZ-GANZA-1-12	

Uchwyt AGIOS
Handle AGIOS
Ручка AGIOS

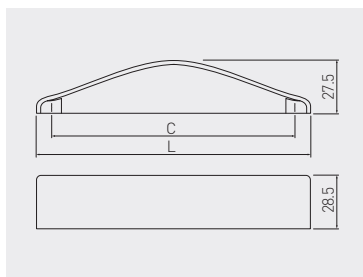

C
mm

L
mm



C mm	L mm	chrom chrome хром	aluminium aluminium алюминий	ZnAl
128	144	UZ-AGIOS-128-01	UZ-AGIOS-128-05	

Uchwyt HILL
Handle HILL
Ручка HILL

DIAMENT
meblarstwa
2018

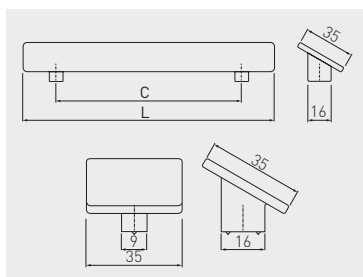

C
mm

L
mm



C mm	L mm	chrom chrome хром	aluminium aluminium алюминий	stal szcztokowana brushed steel шлифованная сталь	czarny chrom black chrome чёрный хром	ZnAl
128	173	UZ-HILL-128-01	UZ-HILL-128-05	UZ-HILL-128-06	UZ-HILL-128-12	
160	205	UZ-HILL-160-01	UZ-HILL-160-05	UZ-HILL-160-06	UZ-HILL-160-12	
gałka knob ручка	-	GZ-HILL-1-01	GZ-HILL-1-05	GZ-HILL-1-06	GZ-HILL-1-12	

Uchwyt MONZA
Handle MONZA
Ручка MONZA

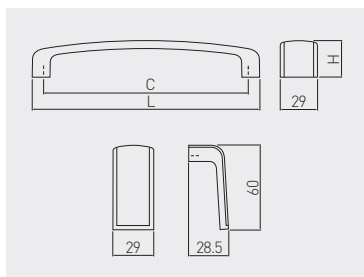

C mm	L mm	H mm	stal szczotkowana / chrom brushed steel / chrome шлифованная сталь / хром	biały / chrom white / chrome белый / хром	czarny / chrom black / chrome чёрный / хром	ZnAl, aluminium ZnAl, алюминий
16	29	28.5	UZ-MONZA16-06	UZ-MONZA16-10	UZ-MONZA16-20	
160	178	29	UZ-MONZA160-06	UZ-MONZA160-10	UZ-MONZA160-20	
256	274	33	UZ-MONZA256-06	UZ-MONZA256-10	UZ-MONZA256-20	
384	402	34	UZ-MONZA384-06	UZ-MONZA384-10	UZ-MONZA384-20	

Uchwyt MONA
Handle MONA
Ручка MONA

NEW

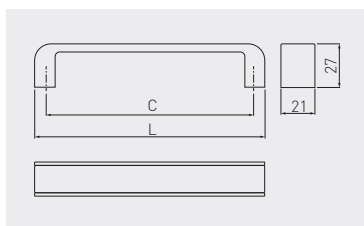

C mm	L mm	chrom / biały chrome / white хром / белый	chrom / czarny chrome / black хром / чёрный	ZnAl
128	142	UZ-MONA-128-01-10	UZ-MONA-128-01-20	
160	178	UZ-MONA-160-01-10	UZ-MONA-160-01-20	
192	206	UZ-MONA-192-01-10	UZ-MONA-192-01-20	
256	270	UZ-MONA-256-01-10	UZ-MONA-256-01-20	
320	338	UZ-MONA-320-01-10	UZ-MONA-320-01-20	

Uchwyt ACRYL
Handle ACRYL
Ручка ACRYL

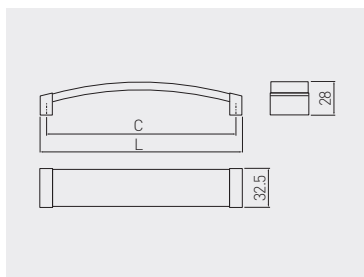



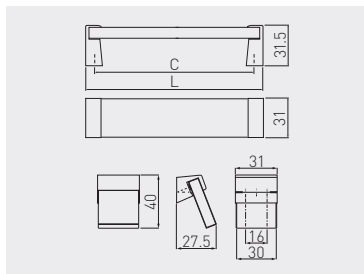

 C mm	 L mm		
160	170	chrom chrome хром	aluminium aluminium алюминий
		UZ-ACRYL-Z111160	*
			ZnAl, акрил ZnAl, acryl ZnAl, акрил

* Produkt dostępny na indywidualne zamówienie / Available for special orders / Товар доступен под заказ

Uchwyt OLIVA
Handle OLIVA
Ручка OLIVA





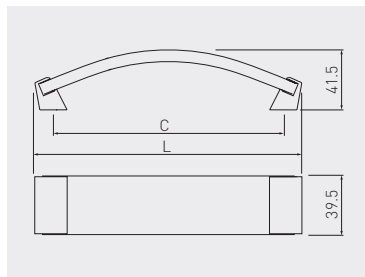

 C mm	 L mm		
160	174	chrom chrome хром	ZnAl, акрил ZnAl, acryl ZnAl, акрил
160	174	UZ-0160PR-01	
192	207	UZ-0192PR-01	
256	271	UZ-0256PR-01	
gałka knob ручка	-	GZ-OLIVA-16-01*	

* Produkt dostępny na indywidualne zamówienie / Available for special orders / Товар доступен под заказ

Uchwyt ROSES
Handle ROSES
Ручка ROSES





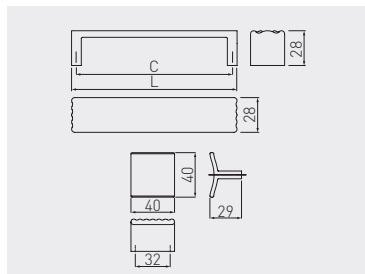

 C mm	 L mm		
160	185	chrom / szkło przezroczyste chrome / transparent glass хром / прозрачное стекло	chrom / szkło białe chrome / white glass хром / белое стекло
256	280	UZ-R160PR-01	UZ-R160BI-01
		UZ-R256PR-01	UZ-R256BI-01
		UZ-ROS160-20	UZ-ROS256-20
		ZnAl, szkło ZnAl, glass ZnAl, стекло	

MODERN

Uchwyt CADIS
Handle CADIS
Ручка CADIS





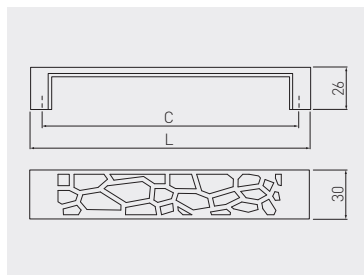

 C mm	 L mm		
32	40	chrom chrome хром	aluminium aluminium алюминий
128	136	GZ-CAD032-01	-
160	168	UZ-CAD128-01	-
320	328	UZ-CAD160-01	UZ-CAD160-05*
		UZ-CAD320-01	UZ-CAD320-05*
		ZnAl	

* Produkt dostępny na indywidualne zamówienie / Available for special orders / Товар доступен под заказ

Uchwyt VERA*
Handle VERA*
Ручка VERA*



 C mm	 L mm		
160	174	chrom chrome хром UZ-VER160-01	kadm cadmium кадмий UZ-VER160-08
			ZnAl

* Produkt dostępny na indywidualne zamówienie / Available for special orders / Товар доступен под заказ

Uchwyt ORIA*
Handle ORIA*
Ручка ORIA*

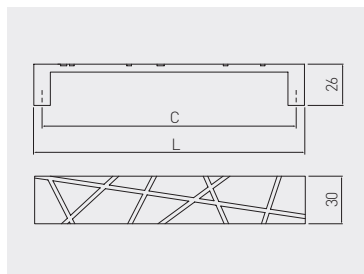

 C mm	 L mm		
160	172	kadm cadmium кадмий UZ-ORI160-08	ZnAl

* Produkt dostępny na indywidualne zamówienie / Available for special orders / Товар доступен под заказ

Uchwyt ARES
Handle ARES
Ручка ARES

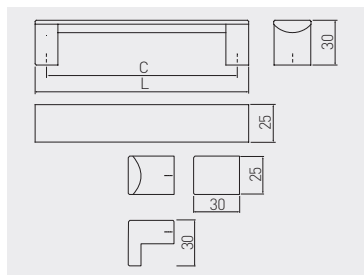

C mm	L mm		
		czarny black чёрный	aluminium aluminium алюминий
96	111	UA-ARS096-20	
128	143	UA-ARS128-20	
160	175	UA-ARS160-20	
192	207	UA-ARS192-20	
224	239	UA-ARS224-20	

C mm	L mm		
		czarny black чёрный	aluminium aluminium алюминий
256	271	UA-ARS256-20	
320	335	UA-ARS320-20	
gatka knob ручка		UA-ARSG30-20	

Uchwyt ASTI
Handle ASTI
Ручка ASTI

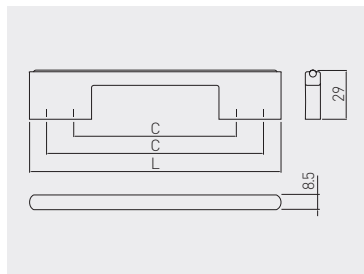

C mm	L mm		
		chrom chrome хром	ZnAl
96 / 128	148	UZ-ASTI096/128-01	
192 / 224	245	UZ-ASTI192/224-01	
288 / 320	340	UZ-ASTI288/320-01	

Uchwyt UZ-G2
Handle UZ-G2
Ручка UZ-G2

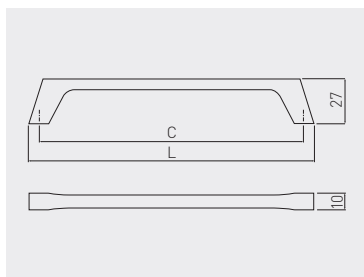

C mm	L mm			
		chrom chrome хром	stal szczotkowana brushed steel шлифованная сталь	ZnAl
160	172	UZ-G2-160-01	UZ-G2-160-06	
224	236	UZ-G2-224-01	UZ-G2-224-06	

Uchwyt BAGIO
Handle BAGIO
Ручка BAGIO

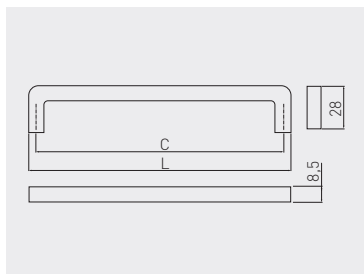

C mm	L mm						
		chrom chrome хром	antyczny mosiądz antique brass античная латунь	aluminium aluminium алюминий	stal szczotkowana brushed steel шлифованная сталь	tytan szczotkowany brushed titanium шлифованный титан	ZnAl
128	136	UZ-BAGIO-128-01	UZ-BAGIO-128-04	UZ-BAGIO-128-05	UZ-BAGIO-128-06	UZ-BAGIO-128-11	
160	168	UZ-BAGIO-160-01	UZ-BAGIO-160-04	UZ-BAGIO-160-05	UZ-BAGIO-160-06	UZ-BAGIO-160-11	
192	200	UZ-BAGIO-192-01	UZ-BAGIO-192-04	UZ-BAGIO-192-05	UZ-BAGIO-192-06	UZ-BAGIO-192-11	
320	328	UZ-BAGIO-320-01	UZ-BAGIO-320-04	UZ-BAGIO-320-05	UZ-BAGIO-320-06	UZ-BAGIO-320-11	

Uchwyt TIVOLI
Handle TIVOLI
Ручка TIVOLI

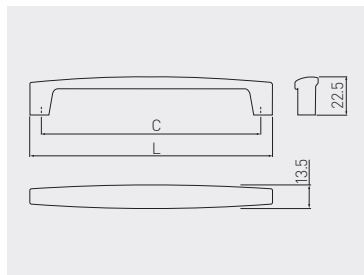

C mm	L mm				
		chrom chrome хром	czarny chrom black chrome чёрный хром	tytan titanium титан	ZnAl
192	206	UZ-TIVOL-192-01	UZ-TIVOL-192-12	UZ-TIVOL-192-13	
320	334	UZ-TIVOL-320-01	UZ-TIVOL-320-12	UZ-TIVOL-320-13	

Uchwyt PRATO
Handle PRATO
Ручка PRATO

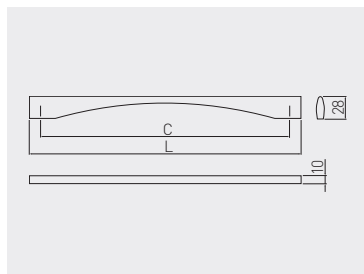

C mm	L mm				
		chrom chrome хром	aluminium aluminium алюминий	stal szcztokowana brushed steel шлифованная сталь	ZnAl
160	189	UZ-PRATO-160-01	UZ-PRATO-160-05	UZ-PRATO-160-06	
320	349	UZ-PRATO-320-01	UZ-PRATO-320-05	UZ-PRATO-320-06	

Uchwyt ANCONA
Handle ANCONA
Ручка ANCONA

NEW

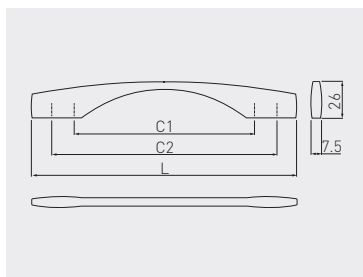

C1 mm	C2 mm	L mm				
			chrom chrome хром	aluminium aluminium алюминий	stal szorstkowana brushed steel шлифованная сталь	ZnAl
128	160	190	UZ-ANCON-128-01	UZ-ANCON-128-05	UZ-ANCON-128-06	
192	224	254	UZ-ANCON-192-01	UZ-ANCON-192-05	UZ-ANCON-192-06	
256	288	318	UZ-ANCON-256-01	UZ-ANCON-256-05	UZ-ANCON-256-06	

Uchwyt SOLANA
Handle SOLANA
Ручка SOLANA

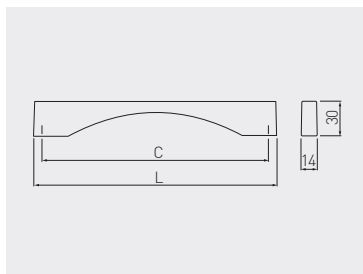

C mm	L mm				
		chrom chrome хром	tytan szorstkowany brushed titanium шлифованный титан	antyczny mosiądz szorstkowany antique brushed brass античная шлифованная латунь	ZnAl
192	208	UZ-SOLANA192-01	UZ-SOLANA192-11	UZ-SOLANA192-09	
320	336	UZ-SOLANA320-01	UZ-SOLANA320-11	UZ-SOLANA320-09	

Uchwyt PADWA*
Handle PADWA*
Ручка PADWA*

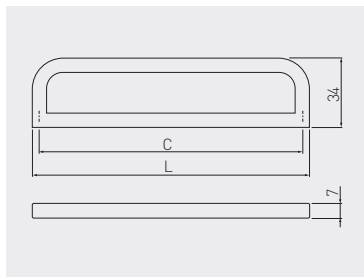

C mm	L mm			
		chrom chrome хром	stal szorstkowana brushed steel шлифованная сталь	ZnAl
128	135	UZ-PADWA128-01	UZ-PADWA128-06	
160	167	UZ-PADWA160-01	UZ-PADWA160-06	
192	199	UZ-PADWA192-01	UZ-PADWA192-06	
224	231	UZ-PADWA224-01	UZ-PADWA224-06	

* Produkt dostępny na indywidualne zamówienie / Available for special orders / Товар доступен под заказ

Uchwyt KATANIA
Handle KATANIA
Ручка KATANIA

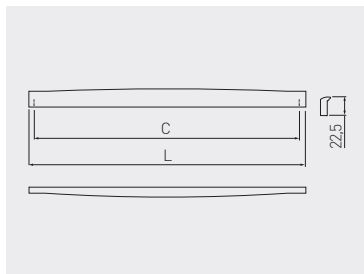

C mm	L mm			
		chrom chrome хром	czarny chrom black chrome чёрный хром	ZnAl
320	334	UZ-KATAN-320-01	UZ-KATAN-320-12	

Gatka IMOLA
Knob IMOLA
Ручка IMOLA

MODERN

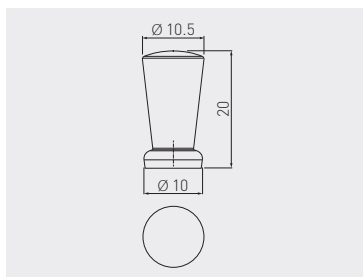

	chrom chrome хром	satyna satin сатин	aluminium aluminium алюминий	stal szcztokowana brushed steel шлифованная сталь	ZnAl
gatka knob ручка	GZ-IMOLA-1-01	GZ-IMOLA-1-02	GZ-IMOLA-1-05	GZ-IMOLA-1-06	

Gatka ROMA
Knob ROMA
Ручка ROMA

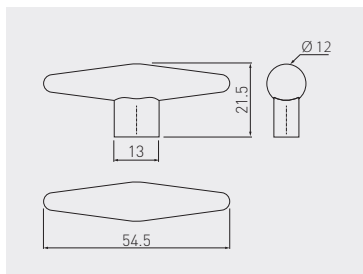

	chrom chrome хром	satyna satin сатин	aluminium aluminium алюминий	stal szcztokowana brushed steel шлифованная сталь	ZnAl
gatka knob ручка	GZ-ROMA-1-01	GZ-ROMA-1-02	GZ-ROMA-1-05	GZ-ROMA-1-06	

Uchwyt UZ-40
Handle UZ-40
Ручка UZ-40

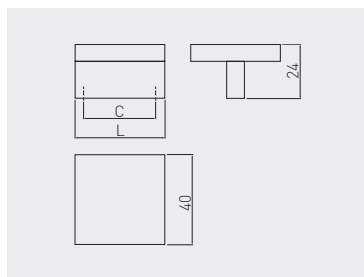
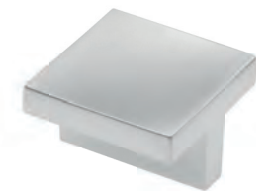

C mm	L mm					
		chrom chrome хром	satyna satin сатин	aluminium aluminium алюминий	stal szczotkowana brushed steel шлифованная сталь	ZnAl
32	40	UZ-40-032-01	UZ-40-032-02	UZ-40-032-05	UZ-40-032-06	

Uchwyt UZ-55
Handle UZ-55
Ручка UZ-55

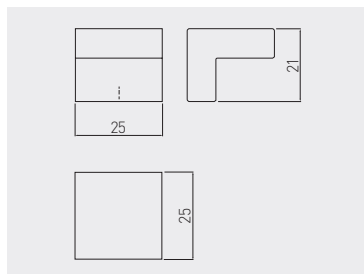

	L mm			
		chrom chrome хром	aluminium aluminium алюминий	ZnAl
gatka knob ручка	25	UZ-55-025-01	UZ-55-025-05	

Uchwyt UZ-60
Handle UZ-60
Ручка UZ-60

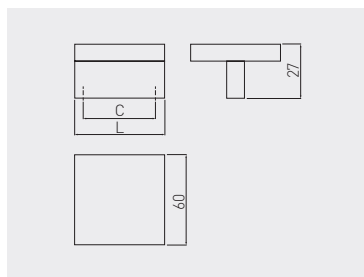
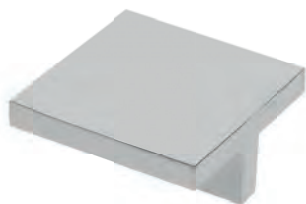

C mm	L mm					
		chrom chrome хром	satyna satin сатин	aluminium aluminium алюминий	stal szczotkowana brushed steel шлифованная сталь	ZnAl
32	60	UZ-60-032-01	UZ-60-032-02	UZ-60-032-05	UZ-60-032-06	

Uchwyt UZ-79F
Handle UZ-79F
Ручка UZ-79F

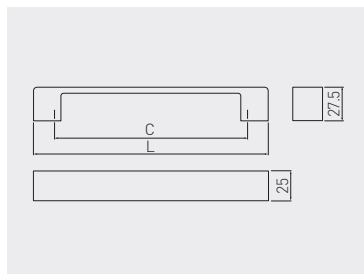



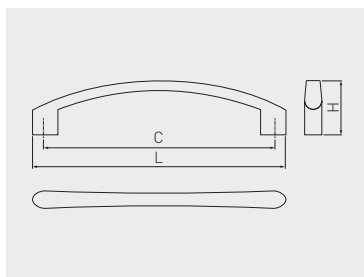

C mm	L mm				
		chrom chrome хром		stal szczotkowana brushed steel шлифованная сталь	ZnAl
160	195	UZ-79F160-01		UZ-79F160-06	
192	227	UZ-79F192-01		UZ-79F192-06	

Uchwyt VARES
Handle VARES
Ручка VARES

NEW



	 C mm	 L mm	 H mm					
				chrom chrome хром	satyna satin сатин	aluminium aluminium алюминий	stal szcztokowana brushed steel шлифованная сталь	ZnAl
96	109	29	UZ-VARES-96-01	UZ-VARES-96-02	UZ-VARES-96-05	UZ-VARES-96-06		
128	140	30	UZ-VARES-128-01	UZ-VARES-128-02	UZ-VARES-128-05	UZ-VARES-128-06		
192	208	31	UZ-VARES-192-01	UZ-VARES-192-02	UZ-VARES-192-05	UZ-VARES-192-06		

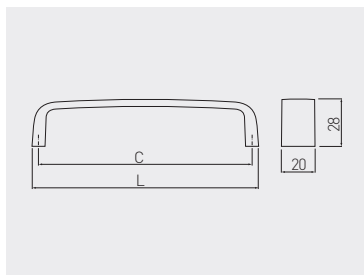

Uchwyt UZ-133
Handle UZ-133
Ручка UZ-133



	 C mm	 L mm					
			chrom chrome хром	satyna satin сатин	aluminium aluminium алюминий	stal szcztokowana brushed steel шлифованная сталь	ZnAl
128	135		UZ-133128-01	UZ-133128-02	UZ-133128-05	UZ-133128-06	

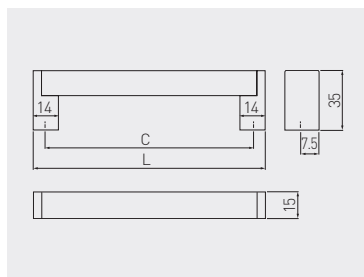

Uchwyt UZ-334
Handle UZ-334
Ручка UZ-334



C mm	L mm		
		stal szczotkowana brushed steel шлифованная сталь	ZnAl, stal ZnAl, steel ZnAl, сталь
128	144	UZ-334128-06	
160	175	UZ-334160-06	
192	206	UZ-334192-06	
256	272	UZ-334256-06	
320	335	UZ-334320-06	

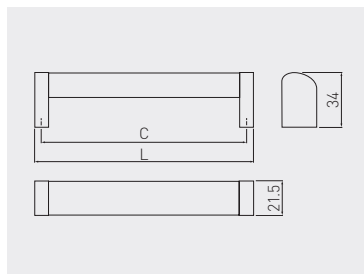

Uchwyt UZ-335
Handle UZ-335
Ручка UZ-335



C mm	L mm		
		stal szczotkowana brushed steel шлифованная сталь	ZnAl, stal ZnAl, steel ZnAl, сталь
128	137	UZ-335128-06	
160	169	UZ-335160-06	
192	212	UZ-335192-06	
256	265	UZ-335256-06	

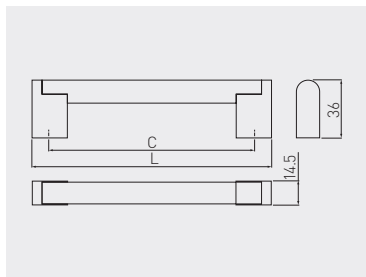





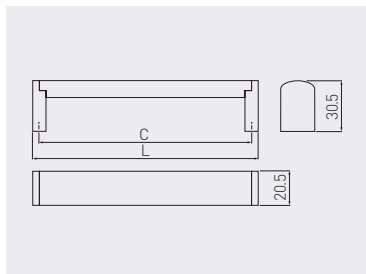

Uchwyt UZ-336
Handle UZ-336
Ручка UZ-336



 C mm	 L mm			
		stal szczotkowana brushed steel шлифованная сталь		ZnAl, stal ZnAl, steel ZnAl, сталь
128	148	UZ-336128-06		
160	182	UZ-336160-06		
192	213	UZ-336192-06		
256	276	UZ-336256-06		
320	340	UZ-336320-06		
416	436	UZ-336416-06		
480	500	UZ-336480-06		





Uchwyt UZ-682
Handle UZ-682
Ручка UZ-682

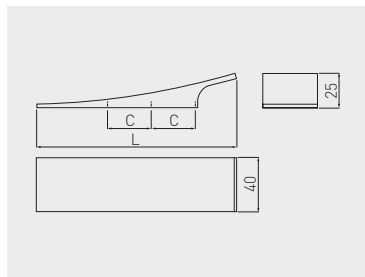

 C mm	 L mm			 C mm	 L mm		
		stal szczotkowana brushed steel шлифованная сталь				stal szczotkowana brushed steel шлифованная сталь	
128	136	UZ-682128-06	stal, ZnAl steel, ZnAl сталь, ZnAl	256	266	UZ-682256-06	stal, ZnAl steel, ZnAl сталь, ZnAl
160	170	UZ-682160-06		320	329	UZ-682320-06	
192	209	UZ-682192-06		416	425	UZ-682416-06	
224	232	UZ-682224-06		480	489	UZ-682480-06	

Uchwyt UZ-804
Handle UZ-804
Ручка UZ-804







 mm	 mm		
		chrom chrome хром	ZnAl
32*	145	UZ-804064-01	



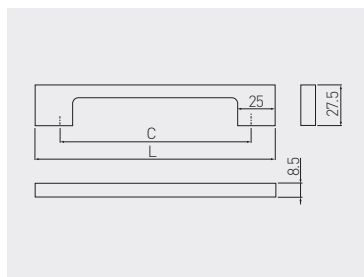

* Mocowanie na 3 wkręty / Mounted with 3 screws / Крепление на 3 самореза.



Uchwyt UZ-819
Handle UZ-819
Ручка UZ-819



 C mm	 L mm						
C	L	chrom chrome хром	satyna satin сатин	aluminium aluminium алюминий	stal szcztokowana brushed steel шлифованная сталь	antyczne srebro antique silver античное серебро	ZnAl
96	129	UZ-819096-01	UZ-819096-02	UZ-819096-05	UZ-819096-06	UZ-819096-07D	
128	161	UZ-819128-01	UZ-819128-02	UZ-819128-05	UZ-819128-06	UZ-819128-07D	
160	193	UZ-819160-01	UZ-819160-02	UZ-819160-05	UZ-819160-06	UZ-819160-07D	
192	225	UZ-819192-01	UZ-819192-02	UZ-819192-05	UZ-819192-06	UZ-819192-07D	
256	289	UZ-819256-01	UZ-819256-02	UZ-819256-05	UZ-819256-06	UZ-819256-07D	
320	353	UZ-819320-01	UZ-819320-02	UZ-819320-05	UZ-819320-06	UZ-819320-07D	

 C mm	 L mm						
C	L	biały white белый	czarny black чёрный		czarny chrom black chrome чёрный хром	antyczna miedź antique copper античная медь	ZnAl
96	129	UZ-819096-10	UZ-819096-20		UZ-819096-12	UZ-819096-14	
128	161	UZ-819128-10	UZ-819128-20		UZ-819128-12	UZ-819128-14	
160	193	UZ-819160-10	UZ-819160-20		UZ-819160-12	UZ-819160-14	
192	225	UZ-819192-10	UZ-819192-20		UZ-819192-12	UZ-819192-14	
256	289	UZ-819256-10	UZ-819256-20		UZ-819256-12	UZ-819256-14	
320	353	UZ-819320-10	UZ-819320-20		UZ-819320-12	UZ-819320-14	

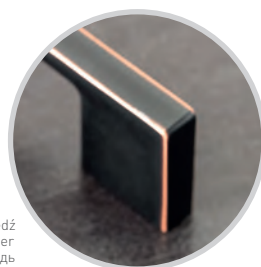

antyczna miedź
antique copper
античная медь

Uchwyt MILANO
Handle MILANO
Ручка MILANO

NEW

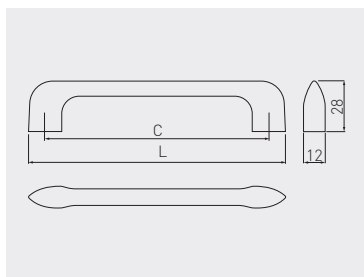

C mm	L mm				
C	L	chrom chrome хром	aluminium aluminium алюминий	stal szcztokowana brushed steel шлифованная сталь	ZnAl
128	146	UZ-MILAN-128-01	UZ-MILAN-128-05	UZ-MILAN-128-06	
256	274	UZ-MILAN-256-01	UZ-MILAN-256-05	UZ-MILAN-256-06	

Uchwyt UZ-870
Handle UZ-870
Ручка UZ-870

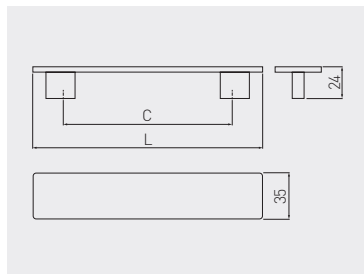

C mm	L mm			
		chrom chrome хром		ZnAl
128	174	UZ-870128-01		

Uchwyt UZ-872
Handle UZ-872
Ручка UZ-872

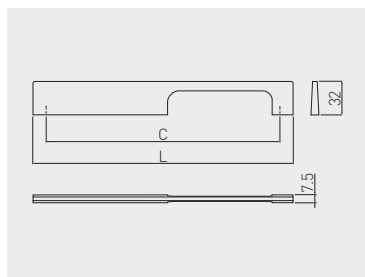

C mm	L mm				
		chrom chrome хром	aluminium aluminium алюминий	stal szcztokowana brushed steel шлифованная сталь	ZnAl
224	249	UZ-872224-01	UZ-872224-05	UZ-872224-06	

Uchwyt UZ-880
Handle UZ-880
Ручка UZ-880

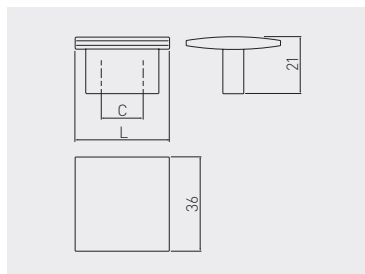

C mm	L mm			
		chrom chrome хром		ZnAl
16	36	UZ-880016-01		

Uchwyt UZ-883
Handle UZ-883
Ручка UZ-883

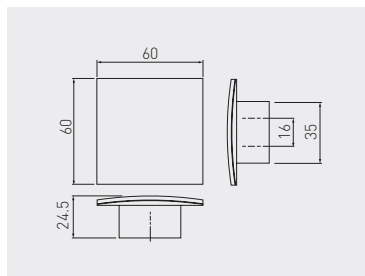

C mm	L mm					
		chrom chrome хром	satyna satin сатин	aluminium aluminium алюминий	stal szczotkowana brushed steel шлифованная сталь	ZnAl
16	60	UZ-883016-01	UZ-883016-02	UZ-883016-05	UZ-883016-06	

Uchwyt US-SKA
Handle US-SKA
Ручка US-SKA

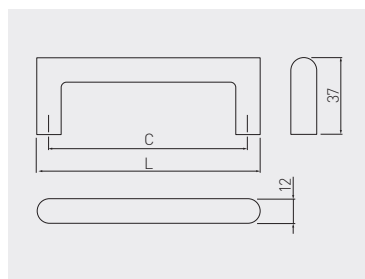

C mm	L mm		
		stal szczotkowana brushed steel шлифованная сталь	stal steel сталь
128	140	US-SKA128-06	
160	172	US-SKA160-06	
192	204	US-SKA192-06	

Na indywidualne zamówienie dostępne również rozstawy: 96, 224, 320, 352, 560 (mm).

Other sizes are available for special orders: 96, 224, 320, 352, 560 (mm).

Под заказ доступны ручки с межцентровым расстоянием: 96, 224, 320, 352, 560 (мм).

Uchwyt US-SK0
Handle US-SK0
Ручка US-SK0

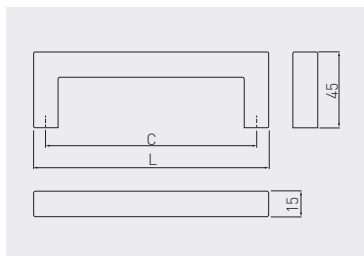

C mm	L mm		
		stal szcztokowana brushed steel шлифованная сталь	stal steel сталь
128	143	US-SK0128-06	
160	175	US-SK0160-06	
192	207	US-SK0192-06	
224	239	US-SK0224-06	
256	271	US-SK0256-06	
320	335	US-SK0320-06	

C mm	L mm		
		stal szcztokowana brushed steel шлифованная сталь	stal steel сталь
384	399	US-SK0384-06	
448	463	US-SK0448-06	
480	495	US-SK0480-06	
576	591	US-SK0576-06	
672	687	US-SK0672-06	
800	815	US-SK0800-06	

Uchwyt UA-A3
Handle UA-A3
Ручка UA-A3

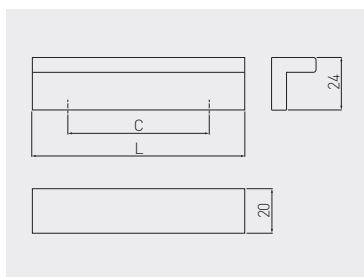

C mm	L mm		
		aluminium aluminium алюминий	aluminium aluminium алюминий
96	128	UA-A3-096128	
128	160	UA-A3-128160	
160	192	UA-A3-160192	
192	224	UA-A3-192224	
256	288	UA-A3-256288	
320	352	UA-A3-320352	

Uchwyt UA-A4
Handle UA-A4
Ручка UA-A4

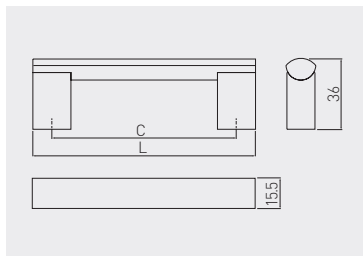

C mm	L mm				
		aluminium aluminium алюминий	stal szczotkowana brushed steel шлифованная сталь		aluminium aluminium алюминий
128	148	UA-AA-04-128	UA-A4-128-06MJ		
160	180	UA-AA-04-160	UA-A4-160-06MJ		
192	212	UA-AA-04-192	*		
224	244	UA-AA-04-224	*		
256	276	UA-AA-04-256	UA-A4-256-06MJ		
288	308	UA-AA-04-288	*		
320	340	UA-AA-04-320	UA-A4-320-06MJ		

Uchwyt UA-B311
Handle UA-B311
Ручка UA-B311

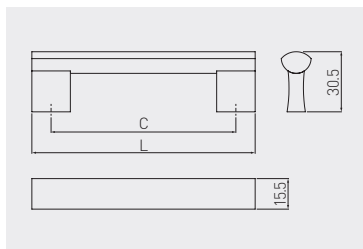

C mm	L mm					
		chrom chrome хром	aluminium aluminium алюминий	czarny black чёрный	stal szczotkowana brushed steel шлифованная сталь	aluminium aluminium алюминий
96	116	*	UA-B0-311096	UA-B0-311096-20M	UA-B31109606MJ*	
128	148	UA-B31112801	UA-B0-311128	UA-B0-311128-20M	UA-B31112806MJ*	
160	180	UA-B31116001	UA-B0-311160	UA-B0-311160-20M	UA-B31116006MJ*	
192	212	UA-B31119201	UA-B0-311192	UA-B0-311192-20M	UA-B31119206MJ*	
224	244	UA-B31122401	UA-B0-311224	UA-B0-311224-20M	UA-B31122406MJ*	
256	276	UA-B31125601	UA-B0-311256	UA-B0-311256-20M	UA-B31125606MJ*	
288	307	*	UA-B0-311288	*	UA-B31128806MJ*	
320	340	UA-B31132001	UA-B0-311320	UA-B0-311320-20M	UA-B31132006MJ*	
480	500	*	UA-B0-311480	*	UA-B31148006MJ*	

* Produkt dostępny na indywidualne zamówienie / Available for special orders / Товар доступен под заказ

Uchwyt UA-B337
Handle UA-B337
Ручка UA-B337

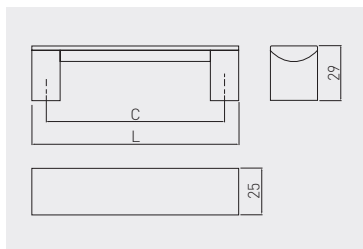

C mm	L mm	chrom chrome хром	aluminium aluminium алюминий	stal szcziotkowana brushed steel шлифованная сталь	
128	143	UA-B33712801	UA-B0-337128	UA-B33712806MJ	aluminium aluminium алюминий
160	175	UA-B33716001	UA-B0-337160	UA-B33716006MJ	
192	207	UA-B33719201	UA-B0-337192	UA-B33719206MJ	
224	239	UA-B33722401	UA-B0-337224	UA-B33722406MJ	
256	271	UA-B33725601	UA-B0-337256	UA-B33725606MJ	
320	335	UA-B33732001	UA-B0-337320	UA-B33732006MJ	
416	431	*	UA-B0-337416	UA-B33741606MJ	
480	495	UA-B33748001	UA-B0-337480	UA-B33748006MJ	

* Produkt dostępny na indywidualne zamówienie / Available for special orders / Товар доступен под заказ

Uchwyt UA-114
Handle UA-114
Ручка UA-114

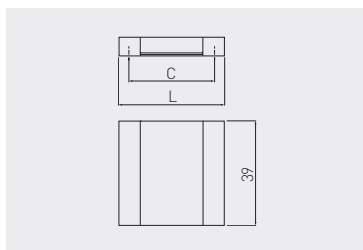

C mm	L mm	satyna satin сатин	aluminium aluminium алюминий	aluminium aluminium алюминий
32	39	UA-AA-114-02	UA-AA-114-05	

Uchwyt UA-18
Handle UA-18
Ручка UA-18

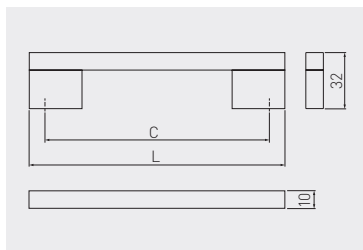

C
mm

L
mm



C mm	L mm	chrom chrome хром	aluminium aluminium алюминий	stal szczerkowana brushed steel шлифованная сталь	
128	146	UA-A18128-01	UA-18-128146	UA-A18128-06MJ	aluminium aluminium алюминий
160	178	UA-A18160-01	UA-18-160178	UA-A18160-06MJ	
192	210	UA-A18192-01	UA-18-192210	UA-A18192-06MJ	
224	242	UA-A18224-01	UA-18-224242	UA-A18224-06MJ	
256	274	UA-A18256-01	UA-18-256274	UA-A18256-06MJ	
320	338	UA-A18320-01	UA-18-320338	UA-A18320-06MJ	
400	418	UA-A18400-01	UA-18-400418	UA-A18400-06MJ	
416	434	UA-A18416-01	UA-18-416434	UA-A18416-06MJ	
480	498	UA-A18480-01	UA-18-480498	UA-A18480-06MJ	

Uchwyt UA-313
Handle UA-313
Ручка UA-313

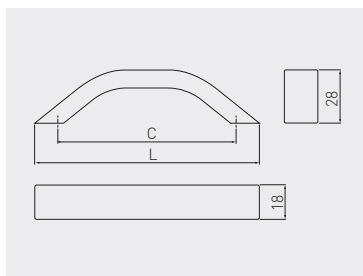

C
mm





L
mm

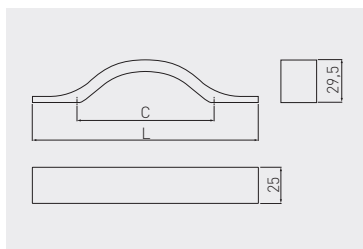

C mm	L mm	aluminium aluminium алюминий	
128	150	UA-00-313128	aluminium aluminium алюминий
160	182	UA-00-313160	
192	214	UA-00-313192	





Uchwyt UA-319
Handle UA-319
Ручка UA-319

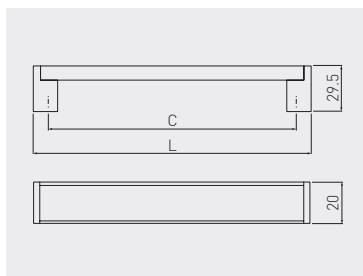

 C mm	 L mm		
		aluminium aluminium алюминий	aluminium aluminium алюминий
96	158	UA-00-319096	
128	189	UA-00-319128	
160	231	UA-00-319160	

Uchwyt LUNA*
Handle LUNA*
Ручка LUNA*





 C mm	 L mm		
		satyna / chrom satin / chrome сатин / хром	aluminium / chrom aluminium / chrome алюминий / хром
160	179	UA-LUNA20160-SN	UA-LUNA20160-AL
192	211	UA-LUNA20192-SN	UA-LUNA20192-AL
256	275	UA-LUNA20256-SN	UA-LUNA20256-AL
320	339	UA-LUNA20320-SN	UA-LUNA20320-AL

* Produkt dostępny na indywidualne zamówienie / Available for special orders / Товар доступен под заказ

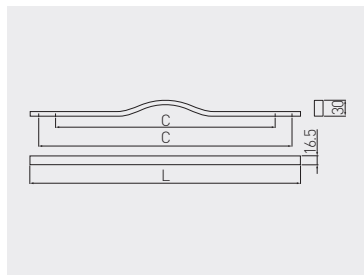



Uchwyt DOPPIO
Handle DOPPIO
Ручка DOPPIO

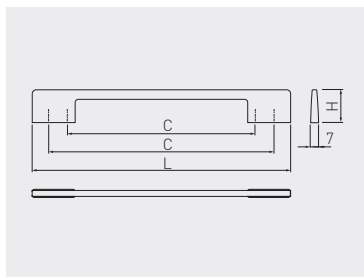

 C mm	 L mm		
192 / 224	256	chrom / aluminium chrome / aluminium хром / алюминий	aluminium aluminium алюминий
416 / 480	512	UA-DOPPIO192-01 UA-DOPPIO416-01	

Uchwyt THIN
Handle THIN
Ручка THIN





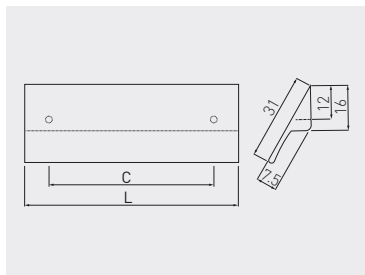

 C mm	 L mm	 H mm					
			chrom chrome хром	satyna satin сатин	aluminium aluminium алюминий	stal szcztokowana brushed steel шлифованная сталь	
96/128	156	24	UZ-TH096128-01	UZ-TH096128-02*	UZ-TH096128-05	UZ-TH096128-06	ZnAl
160/192	220	28	UZ-TH160192-01	UZ-TH160192-02*	UZ-TH160192-05	UZ-TH160192-06	
288/320	348	28	UZ-TH288320-01	UZ-TH288320-02*	UZ-TH288320-05	UZ-TH288320-06	

* Produkt dostępny na indywidualne zamówienie / Available for special orders / Товар доступен под заказ





Uchwyt PICCOLO
Handle PICCOLO
Ручка PICCOLO



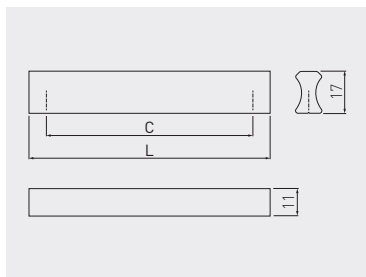



 C mm	 L mm		
		aluminium aluminium алюминий	aluminium aluminium алюминий
64	80	UA-PICCO-64-05	
128	145	UA-PICCO-128-05	
224	240	UA-PICCO-224-05	

Uchwyt ALFA
Handle ALFA
Ручка ALFA



 C mm	 L mm		
		aluminium aluminium алюминий	aluminium aluminium алюминий
32	46	UA-ALFA-32-05	
96	110	UA-ALFA-96-05	
128	142	UA-ALFA-128-05	
160	174	UA-ALFA-160-05	
192	206	UA-ALFA-192-05	

 C mm	 L mm		
		aluminium aluminium алюминий	aluminium aluminium алюминий
224	238	UA-ALFA-224-05	
256	270	UA-ALFA-256-05	
288	302	UA-ALFA-288-05	
320	334	UA-ALFA-320-05	

Uchwyt BETA
Handle BETA
Ручка BETA

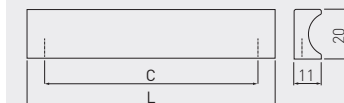

C mm	L mm		
96	110	aluminium aluminium алюминий	aluminium aluminium алюминий
128	142	UA-BETA-128-05	
160	174	UA-BETA-160-05	
192	206	UA-BETA-192-05	

C mm	L mm		
224	238	aluminium aluminium алюминий	aluminium aluminium алюминий
256	270	UA-BETA-256-05	
288	302	UA-BETA-288-05	
320	334	UA-BETA-320-05	

Uchwyt GAMMA
Handle GAMMA
Ручка GAMMA

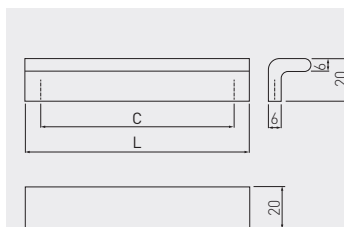

C mm	L mm		
96	110	aluminium aluminium алюминий	aluminium aluminium алюминий
128	142	UA-GAMMA-128-05	
160	174	UA-GAMMA-160-05	
192	206	UA-GAMMA-192-05	

C mm	L mm		
224	238	aluminium aluminium алюминий	aluminium aluminium алюминий
256	270	UA-GAMMA-256-05	
288	302	UA-GAMMA-288-05	
320	334	UA-GAMMA-320-05	

Uchwyt DELTA
Handle DELTA
Ручка DELTA

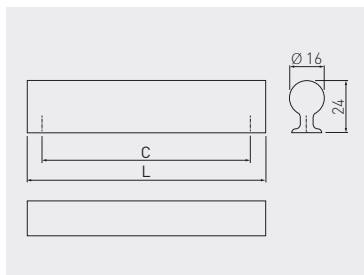

C mm	L mm		
96	110	aluminium aluminium алюминий	aluminium aluminium алюминий
128	142	UA-DELTA-128-05	
160	174	UA-DELTA-160-05	
192	206	UA-DELTA-192-05	

C mm	L mm		
224	238	aluminium aluminium алюминий	aluminium aluminium алюминий
256	270	UA-DELTA-256-05	
288	302	UA-DELTA-288-05	
320	334	UA-DELTA-320-05	

Uchwyt SIGMA
Handle SIGMA
Ручка SIGMA

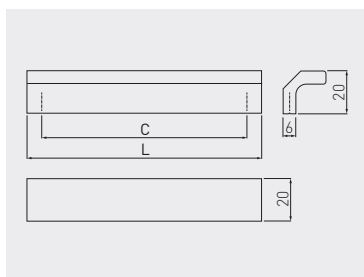

C mm	L mm		
96	110	aluminium aluminium алюминий	aluminium aluminium алюминий
128	142	UA-SIGMA-128-05	
160	174	UA-SIGMA-160-05	
192	206	UA-SIGMA-192-05	
224	238	UA-SIGMA-224-05	
256	270	UA-SIGMA-256-05	
288	302	UA-SIGMA-288-05	
320	334	UA-SIGMA-320-05	

Uchwyt KAPPA
Handle KAPPA
Ручка KAPPA

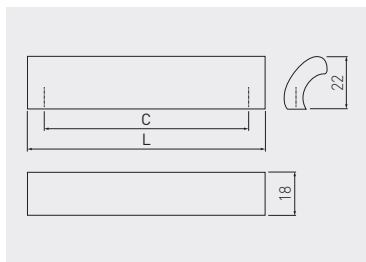

C mm	L mm		
96	110	aluminium aluminium алюминий	aluminium aluminium алюминий
128	142	UA-KAPPA-128-05	
160	174	UA-KAPPA-160-05	
192	206	UA-KAPPA-192-05	
224	238	UA-KAPPA-224-05	
256	270	UA-KAPPA-256-05	
288	302	UA-KAPPA-288-05	
320	334	UA-KAPPA-320-05	

Uchwyt ALRA*
Handle ALRA*
Ручка ALRA*

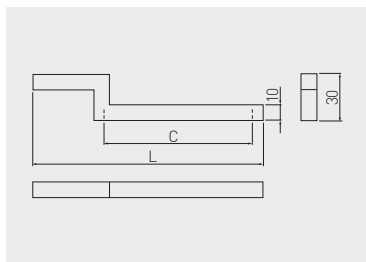

C mm	L mm			
96	149	chrom chrome хром	stal szcztkowana brushed steel шлифованная сталь	ZnAl
		UZ-ALRA096-01	UZ-ALRA096-06	

* Produkt dostępny na indywidualne zamówienie / Available for special orders / Товар доступен под заказ

Uchwyt UA-337
Handle UA-337
Ручка UA-337

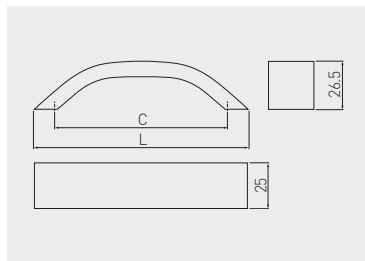

C mm	L mm			
96	116	aluminium aluminium алюминий	czarny black чёрный	aluminium aluminium алюминий
128	146	UA-00-337096	UA-00-337096-20M	
160	180	UA-00-337128	UA-00-337128-20M	
192	212	UA-00-337160	UA-00-337160-20M	
224	244	UA-00-337192	UA-00-337192-20M	
256	275	UA-00-337224	UA-00-337224-20M	
320	340	UA-00-337256	UA-00-337256-20M	



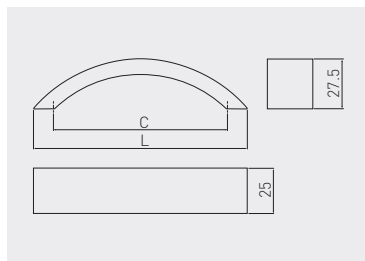

Uchwyt UA-338
Handle UA-338
Ручка UA-338

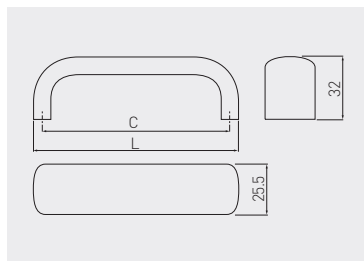

C mm	L mm		
128	137	aluminium aluminium алюминий	aluminium aluminium алюминий
160	169	UA-00-338128	
		UA-00-338160	

Uchwyt UA-340
Handle UA-340
Ручка UA-340



 C mm	 L mm			
		aluminium aluminium алюминий		aluminium aluminium алюминий
128	137	UA-00-340128		
160	169	UA-00-340160		
192	201	UA-00-340192		
224	233	UA-00-340224		
256	265	UA-00-340256		
320	329	UA-00-340320		



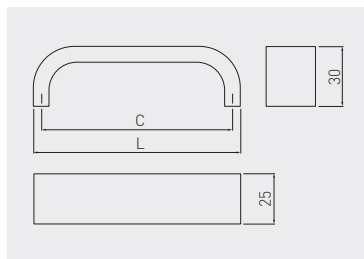

Uchwyt UA-347
Handle UA-347
Ручка UA-347

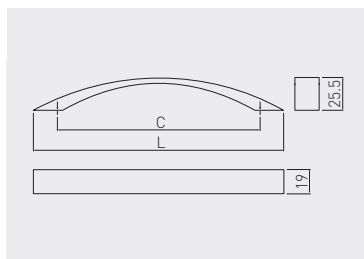

 C mm	 L mm			
		aluminium aluminium алюминий		aluminium aluminium алюминий
128	136	UA-00-347128		
160	168	UA-00-347160		
192	200	UA-00-347192		
224	232	UA-00-347224		
256	264	UA-00-347256		
320	328	UA-00-347320		





Uchwyt CALABRIA
Handle CALABRIA
Ручка CALABRIA

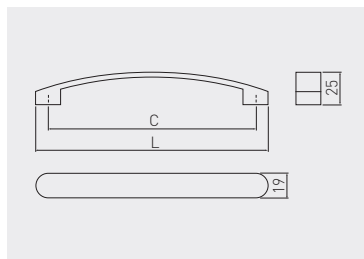

 C mm	 L mm			
160	195	chrom chrome хром	stal szczotkowana brushed steel шлифованная сталь	ZnAl
192	224	UZ-CALABRIA192-01	UZ-CALABRIA192-06	
224	258	UZ-CALABRIA224-01	UZ-CALABRIA224-06	

Uchwyt GENUA
Handle GENUA
Ручка GENUA



 C mm	 L mm				
128	148	chrom chrome хром	satyna satin сатин	aluminium aluminium алюминий	ZnAl
160	180	UZ-GENUA128-01	UZ-GENUA128-02	UZ-GENUA128-05	
		UZ-GENUA160-01	UZ-GENUA160-02	UZ-GENUA160-05	

Uchwyt UZ-G1
Handle UZ-G1
Ручка UZ-G1

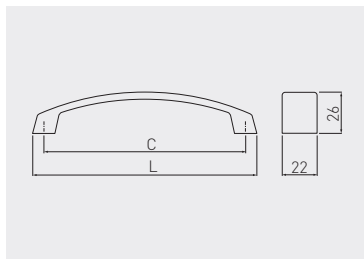

C mm	L mm	chrom chrome хром	aluminium aluminium алюминий	stal szorstkowana brushed steel шлифованная сталь	tytan titanium титан	
128	142	UZ-G1-128-01	UZ-G1-128-05	UZ-G1-128-06	UZ-G1-128-13	ZnAl
160	174	UZ-G1-160-01	UZ-G1-160-05	UZ-G1-160-06	UZ-G1-160-13	
192	206	UZ-G1-192-01	UZ-G1-192-05	UZ-G1-192-06	UZ-G1-192-13	
256	270	UZ-G1-256-01	UZ-G1-256-05	UZ-G1-256-06	UZ-G1-256-13	
320	334	UZ-G1-320-01	UZ-G1-320-05	UZ-G1-320-06	UZ-G1-320-13	
416	430	UZ-G1-416-01	UZ-G1-416-05	UZ-G1-416-06	-	

Uchwyt UZ-01
Handle UZ-01
Ручка UZ-01

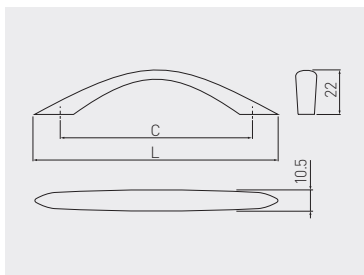

C mm	L mm	chrom chrome хром	satyna satin сатин	mosiądz brass латунь	aluminium aluminium алюминий	
96	121	UZ-01-096-01	UZ-01-096-02	UZ-01-096-03	UZ-01-096-05	ZnAl
128	158	UZ-01-128-01	UZ-01-128-02	UZ-01-128-03	UZ-01-128-05	



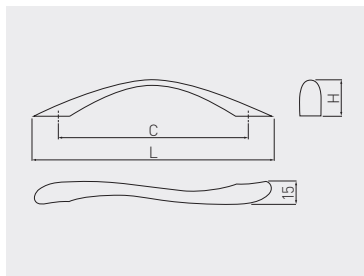

Uchwyt UZ-04
Handle UZ-04
Ручка UZ-04

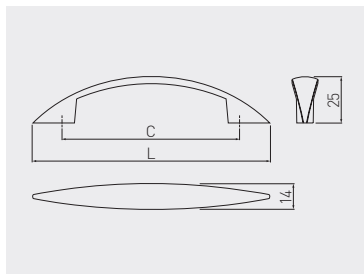

 C mm	 L mm	 H mm					
			chrom chrome хром	satyna satin сатин	mosiądz brass латунь	aluminium aluminium алюминий	ZnAl
96	127	23	UZ-04-096-01	UZ-04-096-02	UZ-04-096-03	UZ-04-096-05	
128	158	24	UZ-04-128-01	UZ-04-128-02	UZ-04-128-03	UZ-04-128-05	

Uchwyt UZ-05
Handle UZ-05
Ручка UZ-05



 C mm	 L mm						
		chrom chrome хром	satyna satin сатин	mosiądz brass латунь	aluminium aluminium алюминий	ZnAl	
96	132	UZ-05-096-01	UZ-05-096-02	UZ-05-096-03	UZ-05-096-05		
128	164	UZ-05-128-01	UZ-05-128-02	UZ-05-128-03	UZ-05-128-05		

Uchwyt UZ-06
Handle UZ-06
Ручка UZ-06

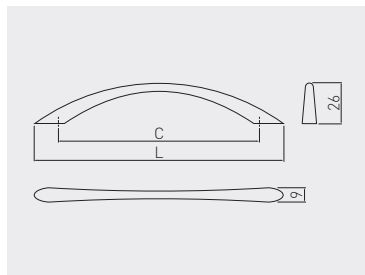

C mm	L mm					
		chrom chrome хром	satyna satin сатин	mosiądz brass латунь	aluminium aluminium алюминий	ZnAl
128	164	UZ-06-128-01	UZ-06-128-02	UZ-06-128-03	UZ-06-128-05	

Uchwyt UZ-07
Handle UZ-07
Ручка UZ-07

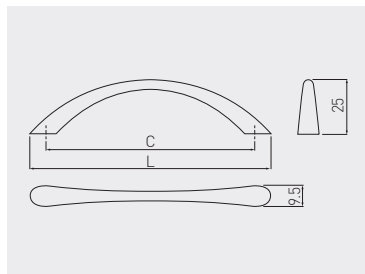

C mm	L mm					
		chrom chrome хром	satyna satin сатин	mosiądz brass латунь	aluminium aluminium алюминий	ZnAl
96	111	UZ-07-096-01	UZ-07-096-02	UZ-07-096-03	UZ-07-096-05	

Uchwyt UZ-Z10
Handle UZ-Z10
Ручка UZ-Z10

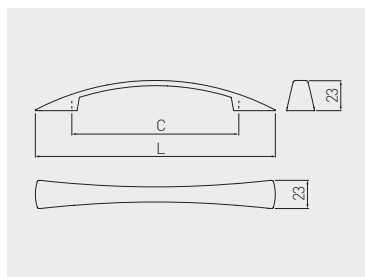

C mm	L mm					
		chrom chrome хром	satyna satin сатин	mosiądz brass латунь	aluminium aluminium алюминий	ZnAl
96	138	UZ-Z10096-01	UZ-Z10096-02	UZ-Z10096-03	UZ-Z10096-05	
128	184	UZ-Z10128-01	UZ-Z10128-02	UZ-Z10128-03	UZ-Z10128-05	

Uchwyt UZ-13
Handle UZ-13
Ручка UZ-13

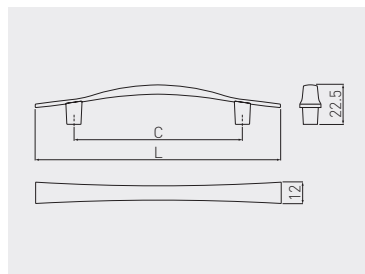

C mm	L mm					
		chrom chrome хром	satyna satin сатин	mosiądz brass латунь	aluminium aluminium алюминий	ZnAl
96	140	UZ-13-096-01	UZ-13-096-02	UZ-13-096-03	UZ-13-096-05	

Uchwyt UZ-14
Handle UZ-14
Ручка UZ-14

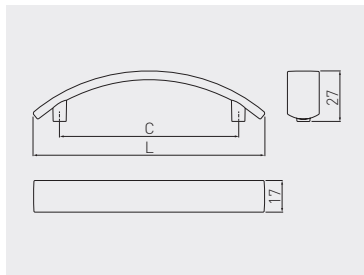

C mm	L mm					
96	138	UZ-14-096-01	UZ-14-096-02	UZ-14-096-03	UZ-14-096-05	ZnAl
128	184	UZ-14-128-01	UZ-14-128-02	UZ-14-128-03	UZ-14-128-05	

Uchwyt CAMAIO
Handle CAMAIO
Ручка CAMAIO

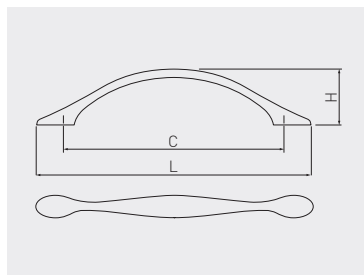

C mm	L mm	H mm				
96	126	23	UZ-CAMAI-96-01	UZ-CAMAI-96-02	UZ-CAMAI-96-06	UZ-CAMAI-96-09
128	160	32,5	UZ-CAMAI-128-01	UZ-CAMAI-128-02	UZ-CAMAI-128-06	UZ-CAMAI-128-09

C mm	L mm	H mm				
96	126	23	UZ-CAMAI-96-10M	UZ-CAMAI-96-20M	UZ-CAMAI-96-12	ZnAl
128	160	32,5	UZ-CAMAI-128-10M	UZ-CAMAI-128-20M	UZ-CAMAI-128-12	

Gatka BERGAMO
Knob BERGAMO
Ручка BERGAMO

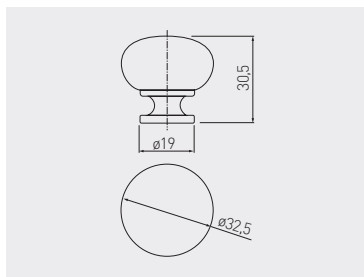

	chrom chrome хром	satyna satin сатин	aluminium aluminium алюминий	stal szorstkowana brushed steel шлифованная сталь	stal steel сталь
gatka knob ручка	GS-BERGA-1-01	GS-BERGA-1-02	GS-BERGA-1-05	GS-BERGA-1-06	



	biały white белый	czarny mat black matt чёрный матовый	czarny chrom black chrome чёрный хром	stal steel сталь
gatka knob ручка	GS-BERGA-1-10	GS-BERGA-1-20M	GS-BERGA-1-12	

Gatka UDINE
Knob UDINE
Ручка UDINE

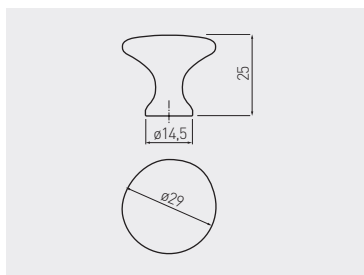

	chrom chrome хром	satyna satin сатин	aluminium aluminium алюминий	stal szorstkowana brushed steel шлифованная сталь	ZnAl
gatka knob ручка	GZ-UDINE-1-01	GZ-UDINE-1-02	GZ-UDINE-1-05	GZ-UDINE-1-06	



	biały mat white matt белый матовый	czarny mat black matt чёрный матовый	czarny chrom black chrome чёрный хром	ZnAl
gatka knob ручка	GZ-UDINE-1-10M	GZ-UDINE-1-20M	GZ-UDINE-1-12	

Gatka TERNI
Knob TERNI
Ручка TERNI

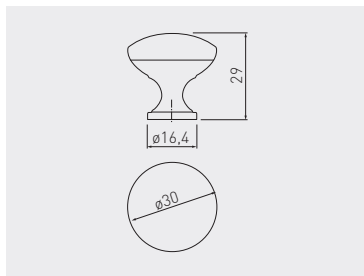

	chrom chrome хром	satyna satin сатин	aluminium aluminium алюминий	stal szczotkowana brushed steel шлифованная сталь	antyczny miedz szorstki antique brushed brass античная шлифованная латунь
gatka knob ручка	GZ-TERNI-1-01	GZ-TERNI-1-02	GZ-TERNI-1-05	GZ-TERNI-1-06	GZ-TERNI-1-09



	biały white белый	czarny mat black matt чёрный матовый	czarny chrom black chrome чёрный хром	ZnAl
gatka knob ручка	GZ-TERNI-1-10	GZ-TERNI-1-20M	GZ-TERNI-1-12	ZnAl

Gatka GZ-1155
Knob GZ-1155
Ручка GZ-1155

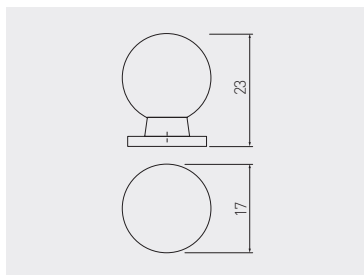

	chrom chrome хром	ZnAl
gatka knob ручка	GZ-WP1155-01	ZnAl

Uchwyt US-C1*
Handle US-C1*
Ручка US-C1*

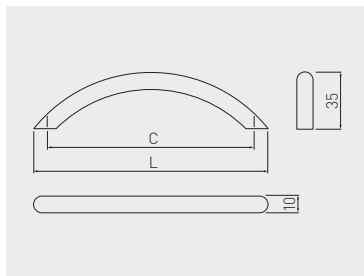

C mm	L mm		
		stal szcztkowana brushed steel шлифованная сталь	stal steel сталь
64	74	US-C1-064-06	
96	111	US-C1-096-06	
128	145	US-C1-128-06	
160	183	US-C1-160-06	

* Produkt dostępny na indywidualne zamówienie / Available for special orders / Товар доступен под заказ

Uchwyt US-C7*
Handle US-C7*
Ручка US-C7*

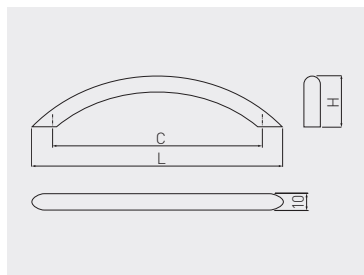

C mm	L mm	H mm		
			chrom chrome хром	stal szcztkowana brushed steel шлифованная сталь
96	119	31	US-C7-096-01	US-C7-096-06
128	153		US-C7-128-01	US-C7-128-06
160	188		US-C7-160-01	US-C7-160-06
192	227		US-C7-192-01	US-C7-192-06
224	253		US-C7-224-01	US-C7-224-06
256	289		US-C7-256-01	US-C7-256-06
288	325	34	US-C7-288-01	US-C7-288-06
320	359		US-C7-320-01	US-C7-320-06
352	406		US-C7-352-01	US-C7-352-06

* Produkt dostępny na indywidualne zamówienie / Available for special orders / Товар доступен под заказ

Gatka GZ-ZH*
Knob GZ-ZH*
Ручка GZ-ZH*

CLASSIC

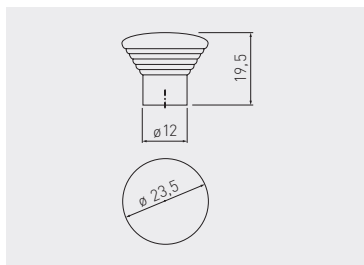

	 C mm		
	chrom chrome хром	stal szczotkowana brushed steel шлифованная сталь	ZnAl
gatka knob ручка	GZ-ZH-011-01A	GZ-ZH-011-06A	

* Produkt dostępny na indywidualne zamówienie / Available for special orders / Товар доступен под заказ

Uchwyt UZ-19*
Handle UZ-19*
Ручка UZ-19*

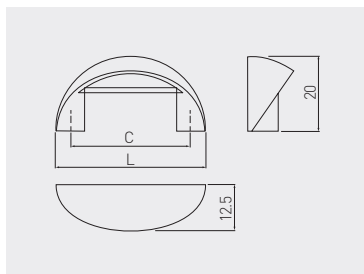



	 C mm	 L mm		
			satyna satin сатин	stal szczotkowana brushed steel шлифованная сталь
	32	40	UZ-19-032-01	UZ-19-032-02
				UZ-19-032-06

* Produkt dostępny na indywidualne zamówienie / Available for special orders / Товар доступен под заказ

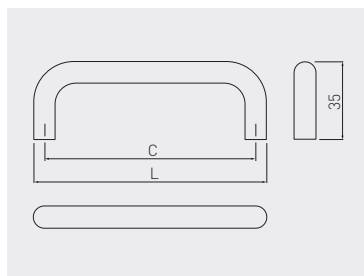
Uchwyt US-U4*
Handle US-U4*
Ручка US-U4*





C mm	L mm			
		chrom chrome хром	stal szczotkowana brushed steel шлифованная сталь	stal steel сталь
64	74	US-U4-064-01	US-U4-064-06	
96	106	US-U4-096-01	US-U4-096-06	
128	138	US-U4-128-01	US-U4-128-06	
160	170	US-U4-160-01	US-U4-160-06	
192	202	US-U4-192-01	US-U4-192-06	
320	330	US-U4-320-01	US-U4-320-06	

* Produkt dostępny na indywidualne zamówienie / Available for special orders / Товар доступен под заказ

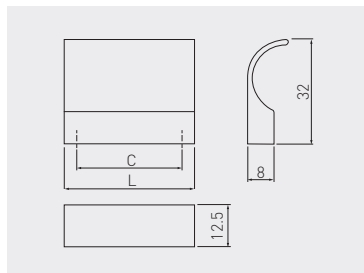
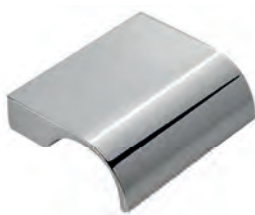
Uchwyt UZ-605*
Handle UZ-605*
Ручка UZ-605*



C mm	L mm			
		chrom chrome хром	aluminium aluminium алюминий	ZnAl
32	40	UZ-605032-01	UZ-605032-05	

* Produkt dostępny na indywidualne zamówienie / Available for special orders / Товар доступен под заказ

Uchwyt TRIEST
Handle TRIEST
Ручка TRIEST

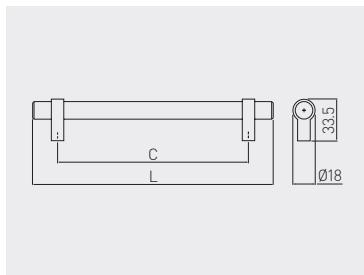

 C mm	 L mm			
		stal szcztokowana brushed steel шлифованная сталь		stal, ZnAl steel, ZnAl сталь, ZnAl
96	136	RS-TRIES-96-06		
128	168	RS-TRIES-128-06		
160	200	RS-TRIES-160-06		
192	232	RS-TRIES-192-06		
256	296	RS-TRIES-256-06		
320	360	RS-TRIES-320-06		



Uchwyt RELING RS
Handle RELING RS
Ручка RELING RS

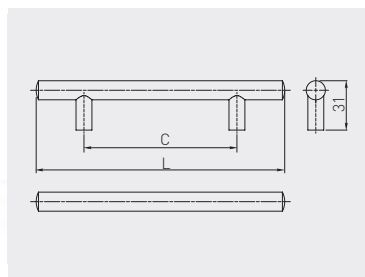

RAIL

		 C mm	 L mm				
		chrom chrome хром	satyna satin сатин	aluminium aluminium алюминий	stal szorstkowana brushed steel шлифованная сталь	antyczna miedź antique copper античная медь	
96	156	RS-156096-01	RS-156096-02	RS-156096-05	RS-156096-06	RS-156096-14	
128	188	RS-188128-01	RS-188128-02	RS-188128-05	RS-188128-06	RS-188128-14	
160	220	RS-220160-01	RS-220160-02	RS-220160-05	RS-220160-06	RS-220160-14	
192	272	RS-272192-01	RS-272192-02	RS-272192-05	RS-272192-06	RS-272192-14	
224	304	RS-304224-01	RS-304224-02	RS-304224-05	RS-304224-06	RS-304224-14	
256	336	RS-336256-01	RS-336256-02	RS-336256-05	RS-336256-06	RS-336256-14	
288	368	RS-368288-01	RS-368288-02	RS-368288-05	RS-368288-06	-	stal steel сталь
320	400	RS-400320-01	RS-400320-02	RS-400320-05	RS-400320-06	RS-400320-14	
352	432	RS-432352-01	RS-432352-02	RS-432352-05	RS-432352-06	-	
384	464	RS-464384-01	RS-464384-02	RS-464384-05	RS-464384-06	-	
416	496	RS-496416-01	RS-496416-02	RS-496416-05	RS-496416-06	-	
448	528	RS-528448-01	RS-528448-02	RS-528448-05	RS-528448-06	-	
480	560	RS-560480-01	RS-560480-02	RS-560480-05	RS-560480-06	-	
512	592	RS-592512-01	RS-592512-02	RS-592512-05	RS-592512-06	-	
544	624	RS-624544-01	RS-624544-02	RS-624544-05	RS-624544-06	-	

Na indywidualne zamówienie dostępne również rozstawy: 576, 608, 640, 627, 704, 736, 768, 800 (mm).

Other sizes are available for special orders: 576, 608, 640, 627, 704, 736, 768, 800 (mm).







Под заказ доступны ручки с межцентровым расстоянием: 576, 608, 640, 627, 704, 736, 768, 800 (мм)

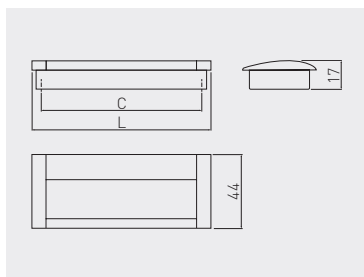

antyczna miedź
antique copper
античная медь

Uchwyt UA-326
Handle UA-326
Ручка UA-326





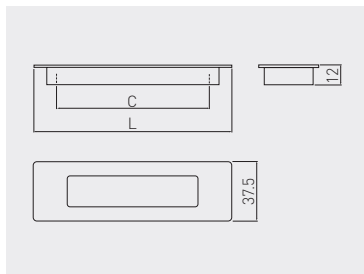

 C mm	 L mm					
		aluminium / chrom aluminium / chrome алюминий / хром		aluminium aluminium алюминий	czarny black чёрный	 aluminium aluminium алюминий
96	124	UA-01-326096-V1		UA-00-326096	UA-00-326096-20M	
128	155	UA-01-326128-V1		UA-00-326128	UA-00-326128-20M	
160	186	UA-01-326160		*	UA-00-326160-20M	

* Produkt dostępny na indywidualne zamówienie / Available for special orders / Товар доступен под заказ

Uchwyt UZ-E6
Handle UZ-E6
Ручка UZ-E6



 C mm	 L mm					
		chrom chrome хром		aluminium aluminium алюминий	stal szorstkowana brushed steel шлифованная сталь	ZnAl
96	124	UZ-E6-096-01		UZ-E6-096-05	UZ-E6-096-06	
128	155	UZ-E6-128-01		UZ-E6-128-05	UZ-E6-128-06	
160	186	UZ-E6-160-01		UZ-E6-160-05	UZ-E6-160-06	

Uchwyt B224
Handle B224
Ручка B224

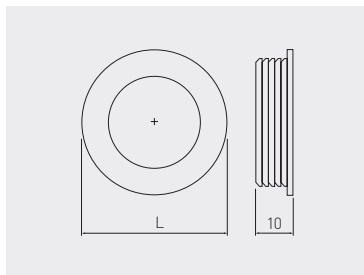

 L mm						
	chrom chrome хром	satyna satin сатин	aluminium aluminium алюминий	biały white белый	czarny black чёрный	ZnAl
40,5	UZ-00B224-01	UZ-00B224-02	UZ-00B224-05	UZ-00B224-10	UZ-00B224-20	

Uchwyt B226
Handle B226
Ручка B226

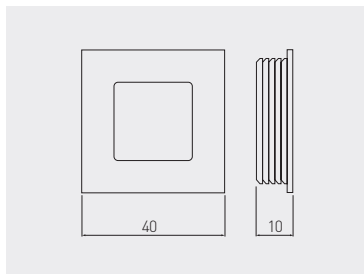

 L mm						
	chrom chrome хром	satyna satin сатин	aluminium aluminium алюминий	biały white белый	czarny black чёрный	ZnAl
40	UZ-00B226-01	UZ-00B226-02	UZ-00B226-05	UZ-00B226-10	UZ-00B226-20	

RECESSED

Uchwyt UZ-R132*
Handle UZ-R132*
Ручка UZ-R132*

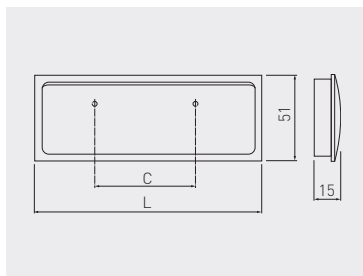

 C mm	 L mm				
		chrom chrome хром	satyna satin сатин	stal szczotkowana brushed steel шлифованная сталь	ZnAl
64	133	UZ-R132-A1-01	UZ-R132-A1-02	UZ-R132-A1-06	

* Produkt dostępny na indywidualne zamówienie / Available for special orders / Товар доступен под заказ

Uchwyt UZ-S50*
Handle UZ-S50*
Ручка UZ-S50*

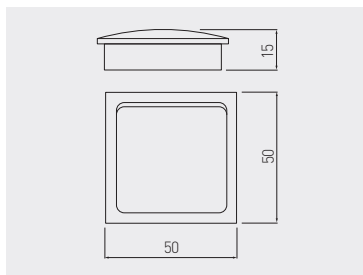



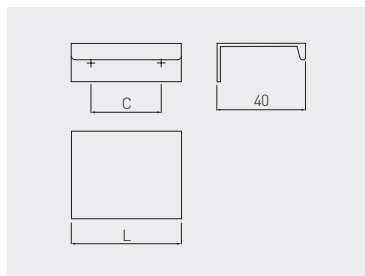

 L mm					
	chrom chrome хром	satyna satin сатин	aluminium aluminium алюминий	stal szczotkowana brushed steel шлифованная сталь	ZnAl
50	UZ-S50-A1-01	UZ-S50-A1-02	UZ-S50-A1-05	UZ-S50-A1-06	

* Produkt dostępny na indywidualne zamówienie / Available for special orders / Товар доступен под заказ





Uchwyt HEXI
Handle HEXI
Ручка HEXI

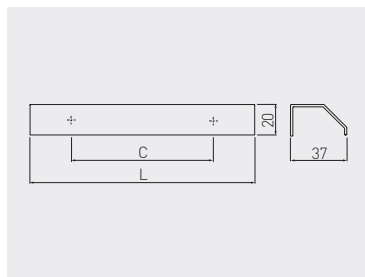

 C mm	 L mm						
		chrom chrome хром	aluminium aluminium алюминий		biały mat white matt белый матовый	czarny mat black matt чёрный матовый	aluminium aluminium алюминий
32	50	UA-HEXI-01	UA-HEXI-05		UA-HEXI-10M	UA-HEXI-20M	
96	150	UA-HEXI96-01	UA-HEXI96-05		UA-HEXI96-10M	UA-HEXI96-20M	
192	225	UA-HEXI192-01	UA-HEXI192-05		UA-HEXI192-10M	UA-HEXI192-20M	
do cięcia to cut для резки	3500	-	UA-HEXI-3500-05		-	-	

Uchwyt PAXO
Handle PAXO
Ручка PAXO



 C mm	 L mm			
		aluminium aluminium алюминий		
32	50	UA-PAXO-32-50-05	aluminium aluminium алюминий	
96	150	UA-PAXO-96-150-05		
224	250	UA-PAXO-224-250-05		
320	350	UA-PAXO-320-350-05		
do cięcia to cut для резки	3500	UA-PAXO-3500-05		

Uchwyt TREX
Handle TREX
Ручка TREX

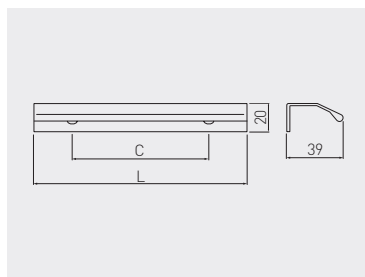

C mm	L mm		
		aluminium aluminium алюминий	aluminium aluminium алюминий
32	50	UA-TREX-32-50-05	
96	150	UA-TREX-96-150-05	
224	250	UA-TREX-224-250-05	
320	350	UA-TREX-320-350-05	
do cięcia to cut для резки	3500	UA-TREX-3500-05	



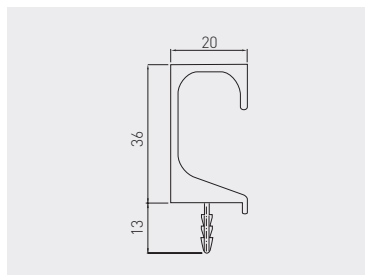

Uchwyt PROFIL C
Handle PROFIL C
Ручка PROFIL C

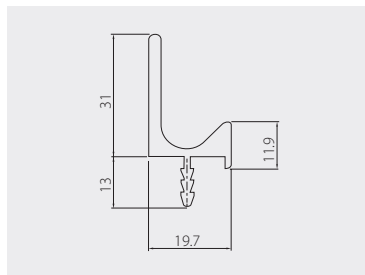

C mm	L mm		
		aluminium aluminium алюминий	aluminium aluminium алюминий
do cięcia to cut для резки	3500	PA-0242-35-50	

Uchwyt PROFIL L
Handle PROFIL L
Ручка PROFIL L





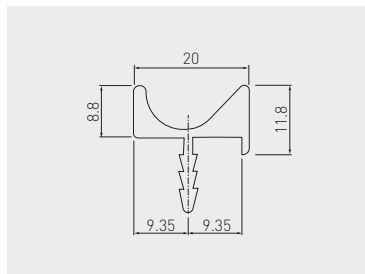

 C mm	 L mm		
do cięcia to cut для резки	3500	aluminium aluminium алюминий	aluminium aluminium алюминий
		PA-0243-35-50	

Uchwyt PROFIL U
Handle PROFIL U
Ручка PROFIL U

NEW





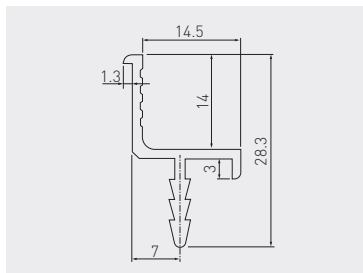

 C mm	 L mm		
do cięcia to cut для резки	3500	aluminium aluminium алюминий	aluminium aluminium алюминий
		PA-0244-35-50	

Uchwyt PROFIL J
Handle PROFIL J
Ручка PROFIL J

NEW





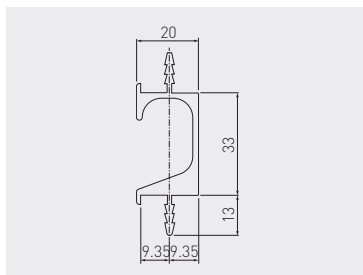
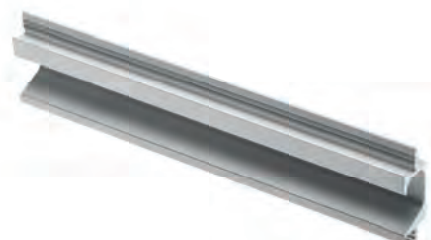

 C mm	 L mm		
do cięcia to cut для резки	3500	aluminium aluminium алюминий	aluminium aluminium алюминий
		PA-0245-35-50	

Uchwyt PROFIL C2
Handle PROFIL C2
Ручка PROFIL C2

NEW



 C mm	 L mm		
do cięcia to cut для резки	3500	aluminium aluminium алюминий	aluminium aluminium алюминий
		PA-0241-35-50	

Uchwyt METRON
Handle METRON
Ручка METRON

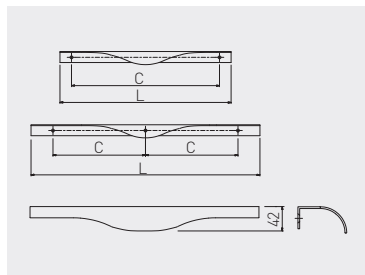

C
mm

L
mm



		chrom chrome хром	aluminium aluminium алюминий	
256	296	UA-METRO-256-296-18-01	UA-METRO-256-296-18-05	aluminium aluminium алюминий
320	396	UA-METRO-320-396-18-01	UA-METRO-320-396-18-05	
2 x 224*	496	UA-METRO-224-496-18-01	UA-METRO-224-496-18-05	
2 x 256*	596	UA-METRO-256-596-18-01	UA-METRO-256-596-18-05	
2 x 352*	796	UA-METRO-352-796-18-01	UA-METRO-352-796-18-05	

* Mocowanie na 3 wkręty / Mounted with 3 screws / Крепление на 3 самореза



Gatka J4
Knob J4
Ручка J4

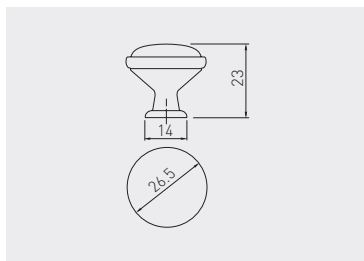

motyw pattern рисунок	antyczny mosiądz antique brass античная латунь	antyczne srebro antique silver старинное серебро	
autumn rose	GP-0728-J4-B	-	ZnAl, porcelana ZnAl, porcelain ZnAl, фарфор
spring flower	GP-0728-J4-R	-	
blue rose	GP-0728-J4-A-04	GP-0728-J4-A-07	
orient gold	GP-0728-J4-C-04	-	



autumn rose



spring flower



blue rose



orient gold

Uchwyt 728B
Handle 728B
Ручка 728B

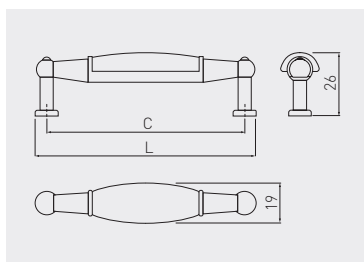

motyw pattern рисунок	C mm	L mm	antyczny mosiądz antique brass античная латунь	
spring flower	96	106	UP-WP0728-BR	ZnAl, porcelana ZnAl, porcelain ZnAl, фарфор
country	96	106	UP-WP0728-BK	
ornament	96	106	UP-WP0728-BX	
autumn rose	96	106	UP-WP0728-BB	



spring flower



country



ornament



autumn rose

Uchwyt 728P
Handle 728P
Ручка 728P

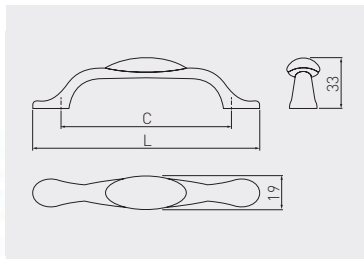

motyw pattern рисунок	C mm	L mm	antyczny mosiądz antique brass античная латунь	antyczne srebro antique silver старинное серебро	ZnAl, porcelana ZnAl, porcelain ZnAl, фарфор
blue rose	96	125	UP-WP0728-PA-04	UP-WP0728-PA-07	
orient gold	96	125	UP-WP0728-PC-04	-	
ornament	96	125	UP-WP0728-PX	-	
autumn rose	96	125	UP-WP0728-PB	-	
spring flower	96	125	UP-WP0728-PR	-	
country	96	125	UP-WP0728-PK	-	
milky	96	125	UP-WP0728-P0	-	



blue rose



orient gold



ornament



autumn rose



spring flower



country



milky

Uchwyt ALATRI
Handle ALATRI
Ручка ALATRI

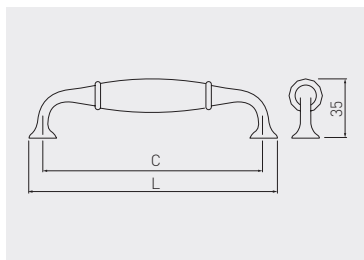

C mm	L mm	antyczny mosiądz antique brass античная латунь	ZnAl, porcelana ZnAl, porcelain ZnAl, фарфор
128	144	UZ-ALATR-128-04	

Uchwyt VASTO
Handle VASTO
Ручка VASTO

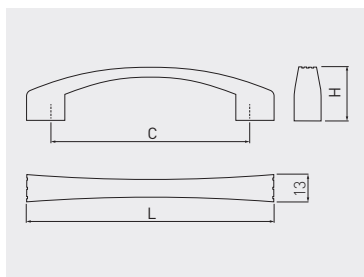

C mm	L mm	H mm		
			antyczny miedź szczotkowany antique brushed brass античная шлифованная латунь	ZnAl
96	120	26	UZ-VASTO-96-09	
128	151	27	UZ-VASTO-128-09	

Uchwyt PALERMO
Handle PALERMO
Ручка PALERMO

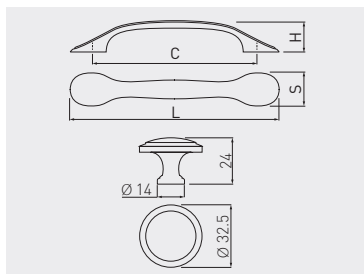

C mm	L mm	H mm	S mm		
				antyczne srebro antique silver античное серебро	ZnAl
96	127	22.5	23	UZ-PALER-96-07	
128	159	23	25	UZ-PALER-128-07	
gatka knob ручка	-	-	-	GZ-PALER-1-07	

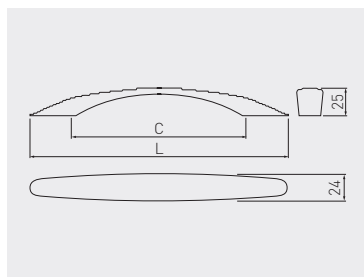

Uchwyt BELLA
Handle BELLA
Ручка BELLA



 C mm	 L mm		
160	236	antyczny mosiądz szczotkowany antique brushed brass античная шлифованная латунь	ZnAl
UZ-BELLA160-09			

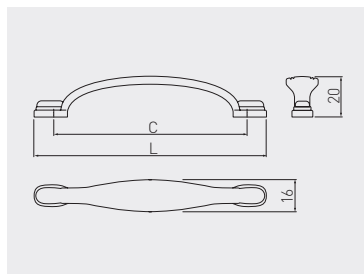

Uchwyt UZ-10
Handle UZ-10
Ручка UZ-10

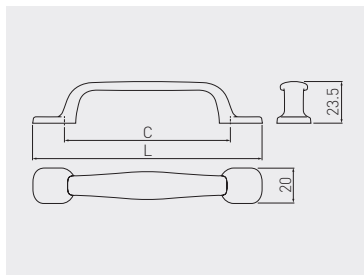

 C mm	 L mm		
96	120	antyczny mosiądz antique brass античная латунь	ZnAl
UZ-10-096-N04			

Uchwyt UZ-12
Handle UZ-12
Ручка UZ-12



C mm	L mm			ZnAl
96	131	antyczny mosiądz antique brass античная латунь	czarny mat black matt чёрный матовый	
		UZ-12-096-04	UZ-12-096-20M	

Uchwyt WERONA
Handle WERONA
Ручка WERONA

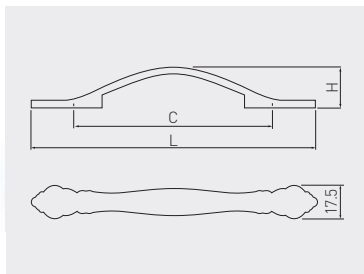

C mm	L mm	H mm			ZnAl
96	148	24,5	antyczny mosiądz szczotkowany antique brushed brass античная шлифованная латунь	czarny chrom black chrome чёрный хром	
128	183	26,5	UZ-WERON-96-04	UZ-WERON-96-09	UZ-WERON-96-12
			UZ-WERON-128-04	UZ-WERON-128-09	UZ-WERON-128-12

Gatka ARDEA
Knob ARDEA
Ручка ARDEA

NEW

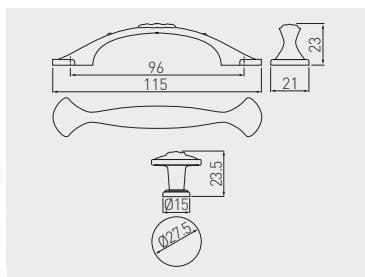

C mm	L mm		
		antyczny mosiądz antique brass античная латунь	
96	115	UZ-ARDEA-96-04	ZnAl
gatka knob ручка	-	GZ-ARDEA-1-04	





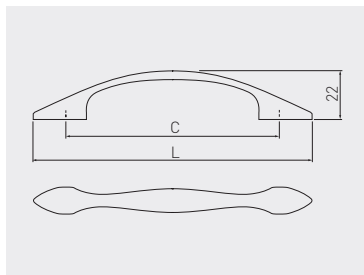

Uchwyt VINCENZA
Handle VINCENZA
Ручка VINCENZA

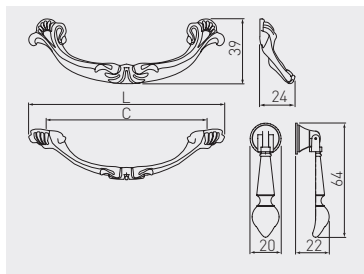

 C mm	 L mm		
96	125	antyczny mosiądz antique brass античная латунь	ZnAl
		UZ-VINCE-96-04	

Uchwyt APRILLA
Handle APRILLA
Ручка APRILLA



 C mm	 L mm		
96	122	antyczny mosiądz antique brass античная латунь	ZnAl
		UZ-APRIL-96-04	
kotatka knocker ручка		KT-APRIL-1-04	

Uchwyt AVELI
Handle AVELI
Ручка AVELI

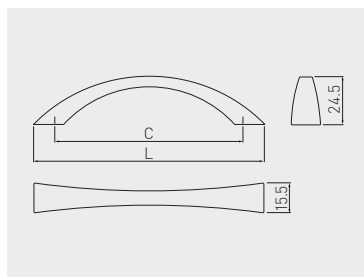

 C mm	 L mm		
96	118	antyczny mosiądz antique brass античная латунь	ZnAl
UZ-AVELI-96-04			

Uchwyt ARCHE*
Handle ARCHE*
Ручка ARCHE*

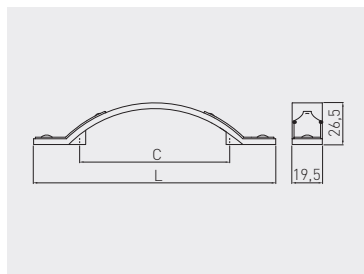

 C mm	 L mm		
96	155	antyczny mosiądz szczotkowany antique brushed brass античная шлифованная латунь	ZnAl
UZ-ARCH096-AEB			

* Produkt dostępny na indywidualne zamówienie / Available for special orders / Товар доступен под заказ

Uchwyt AREZO
Handle AREZO
Ручка AREZO

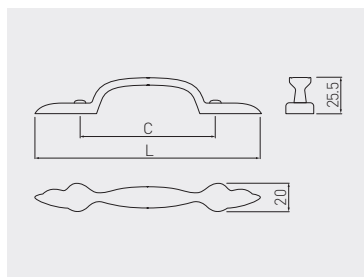

C mm	L mm		
96	160	antyczny mosiądz antique brass античная латунь	ZnAl
		UZ-AREZO-96-04	

Uchwyt ABIATE
Handle ABIATE
Ручка ABIATE

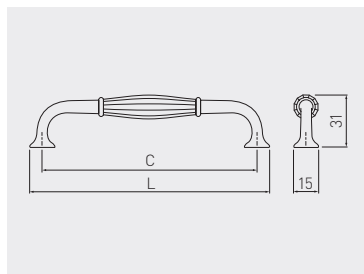

C mm	L mm		
128	143	antyczny mosiądz antique brass античная латунь	ZnAl
		UZ-ABIAT-128-04	

Uchwyt ADRIN
Handle ADRIN
Ручка ADRIN

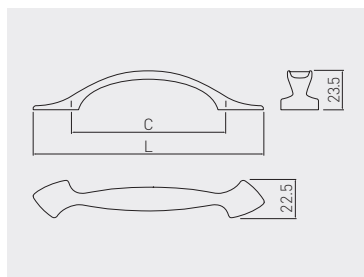

C mm	L mm		
96	139	antyczny mosiądz antique brass античная латунь	ZnAl
		UZ-ADRIN-96-04	

Uchwyt ACERA
Handle ACERA
Ручка ACERA

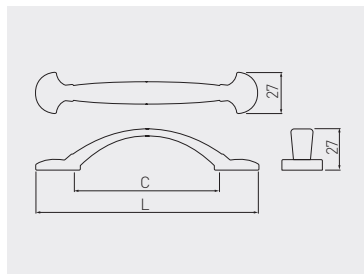

C mm	L mm		
96	147	antyczny mosiądz antique brass античная латунь	ZnAl
		UZ-ACERA-96-04	

Uchwyt OLBIA
Handle OLBIA
Ручка OLBIA

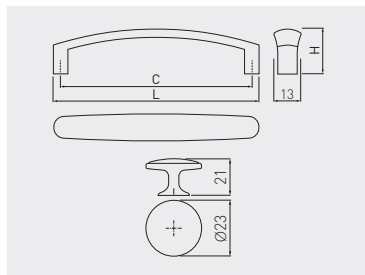

 C mm	 L mm	 H mm		
			antyczny mosiądz antique brass античная латунь	ZnAl
96	103	22	UZ-OLBIA-96-04	
128	136	24	UZ-OLBIA-128-04	
gatka knob ручка	-	-	GZ-OLBIA-1-04	

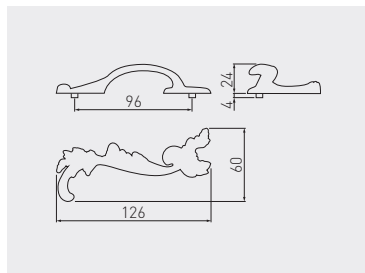

Uchwyt LATINA
Handle LATINA
Ручка LATINA



 C mm		
96	antyczny mosiądz antique brass античная латунь	ZnAl
	UZ-LATIN-96-04	

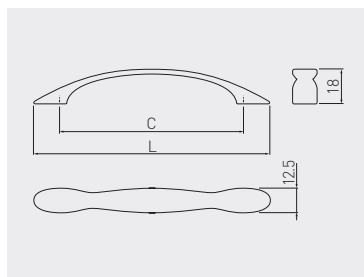



Uchwyt ANZIO
Handle ANZIO
Ручка ANZIO

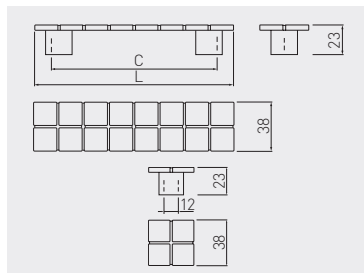

 C mm	 L mm		
96	123	antyczny mosiądz antique brass античная латунь	ZnAl
		UZ-ANZIO-96-04	

Uchwyt AZTEK
Handle AZTEK
Ручка AZTEK



 C mm	 L mm		
128	155	antyczny mosiądz antique brass античная латунь	ZnAl
160	194	UZ-AZ-128-04	
160	194	UZ-AZ-160-04	
gałka knob ручка	38	UZ-AZ-012-04	

Uchwyt MARSALA
Handle MARSALA
Ручка MARSALA

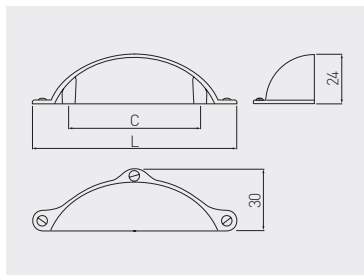

C mm	L mm				
64	99,5	antyczne srebro antique silver античное серебро	antyczny mosiądz szczotkowany antique brushed brass античная шлифованная латунь	biały mat white matt белый матовый	ZnAl
		UZ-MARSA-64-07	UZ-MARSA-64-09	UZ-MARSA-64-10M	

C mm	L mm				
64	99,5	tytan szczotkowany brushed titanium шлифованный титан	czarny mat black matt чёрный матовый	ZnAl	
		UZ-MARSA-64-11	UZ-MARSA-64-20M		



Uchwyt ROYAL
Handle ROYAL
Ручка ROYAL

GZ-ROYAL3-1-10/03



UZ-ROYAL4-96-03



UZ-ROYAL1-96-10/03



UZ-ROYAL2-96-10/03



UZ-ROYAL3-96-10/03



UZ-ROYAL5-128-10-03

NEW

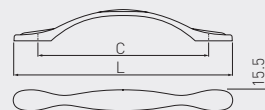
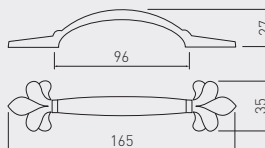
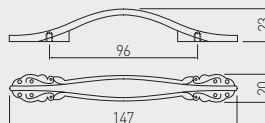
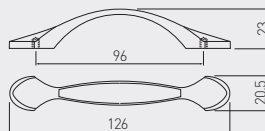
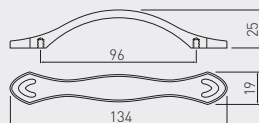
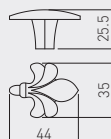

motyw pattern рисунок	C mm	L mm	biały / złoty white / gold белый / золото	ZnAl
latina	96	126	UZ-ROYAL1-96-10/03	ZnAl
werona	96	147	UZ-ROYAL2-96-10/03	
genova	96	165	UZ-ROYAL3-96-10/03	
reggio	96	134	UZ-ROYAL4-96-03	
piano	96	131	UZ-ROYAL5-96-10-03	
	128	164	UZ-ROYAL5-128-10-03	
genova	gatka knob ручка	35	GZ-ROYAL3-1-10/03	

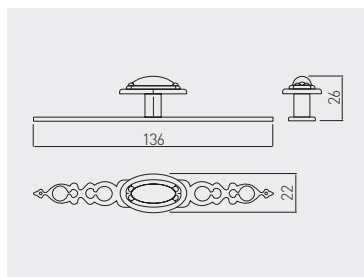

Gatka UZ-WP146
 Knob UZ-WP146
 Ручка UZ-WP146



	 
	antyczny mosiądz antique brass античная латунь
gatka knob ручка	UZ-WP146-04
	ZnAl

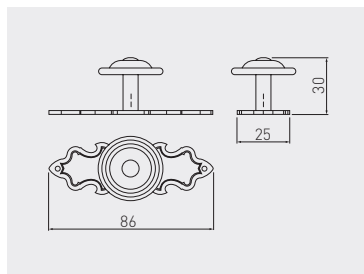

Gatka GZ-1136
 Knob GZ-1136
 Ручка GZ-1136



	 
	antyczny mosiądz antique brass античная латунь
gatka knob ручка	GZ-WP1136-04
	ZnAl

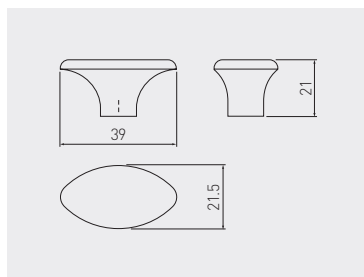

Gatka GZ-1148
Knob GZ-1148
Ручка GZ-1148

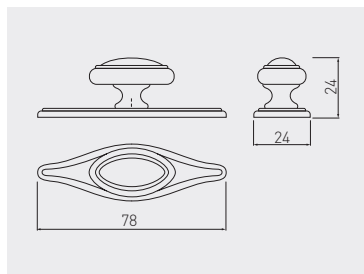

	 
	antyczny mosiądz antique brass античная латунь
gatka knob ручка	GZ-WP1148-04
	ZnAl

Gatka GZ-1152*
Knob GZ-1152*
Ручка GZ-1152*





	 
	antyczny mosiądz antique brass античная латунь
gatka knob ручка	GZ-WP1152-04
	ZnAl

* Produkt dostępny na indywidualne zamówienie / Available for special orders / Товар доступен под заказ

Uchwyt RENNES
Handle RENNES
Ручка RENNES



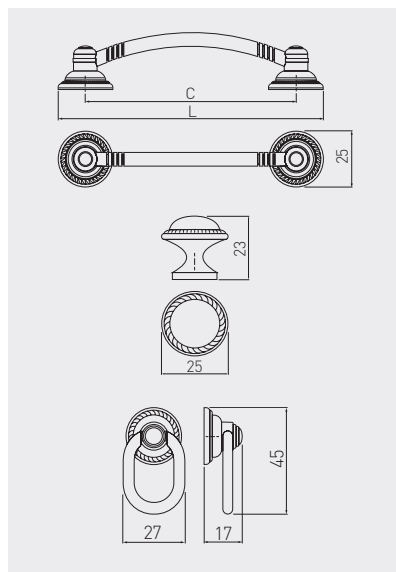

C mm	L mm		
96	121	antyczny mosiądz antique brass античная латунь	ZnAl
kołatka knocker ручка		UZ-REN096-04A	
gátka knob ручка		UZ-RENG01-04A	

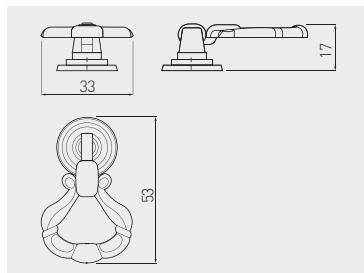

Kołatka KT-1147
Knocker KT-1147
Ручка KT-1147



		
kołatka knocker ручка	antyczny mosiądz antique brass античная латунь	ZnAl
	KT-WP1147-04	

Gatka FROSINO
Knob FROSINO
Ручка FROSINO

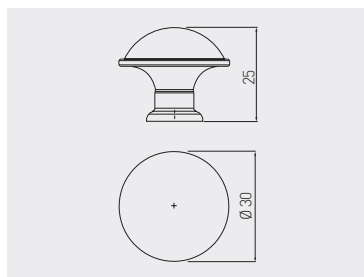

	antyczny mosiądz antique brass античная латунь	antyczny mosiądz szcztokowany antique brushed brass античная шлифованная латунь	ZnAl
gatka knob ручка	GZ-FROSI-1-04	GZ-FROSI-1-09	

Gatka CENTO
Knob CENTO
Ручка CENTO

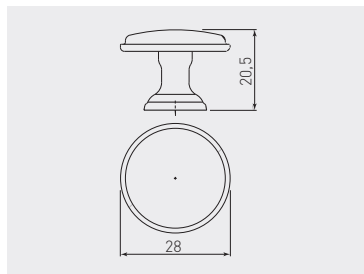

	antyczny mosiądz antique brass античная латунь	antyczne srebro antique silver античное серебро	antyczna miedź antique copper античная медь	czarny mat black matt чёрный матовый	ZnAl
gatka knob ручка	GZ-CENTO-1-04	GZ-CENTO-1-07	GZ-CENTO-1-14	GZ-CENTO-1-20M	

Gatka IMPERIA
Knob IMPERIA
Ручка IMPERIA

RETRO

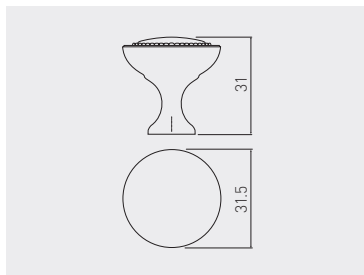





	satyna satin сатин	tytan szczotkowany brushed titanium шлифованный титан	czarny mat black matt чёрный матовый	aluminium aluminium алюминий
gatka knob ручка	GA-IMPER-1-02B	GA-IMPER-1-11	GA-IMPER-1-20M	

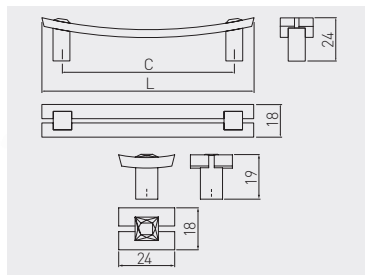
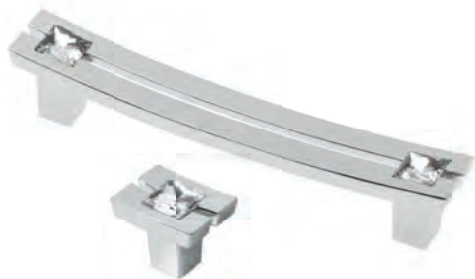





Uchwyt UZ-71C
Handle UZ-71C
Ручка UZ-71C

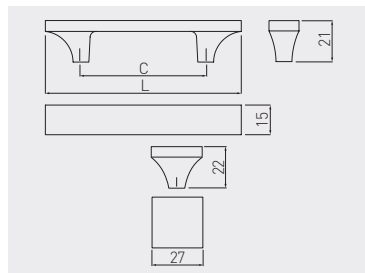

 C mm	 L mm		
96	118	chrom chrome хром	ZnAl
gatka knob ручка		UZ-71C096-01 GZ-71C024-01	





Uchwyt UZ-02C
Handle UZ-02C
Ручка UZ-02C

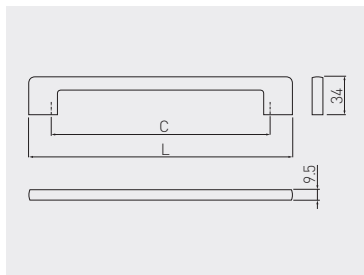

 C mm	 L mm		
64	99	chrom chrome хром	ZnAl, szkło ZnAl, glass ZnAl, стекло
96	135	UZ-02C064-01 UZ-02C096-01	
gatka knob ручка	27	UZ-02CF27-01	

Uchwyt UZ-CRA14*
Handle UZ-CRA14*
Ручка UZ-CRA14*





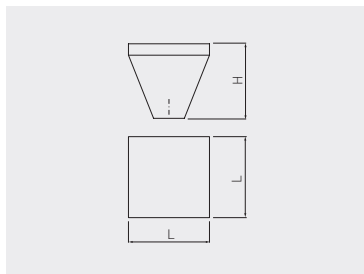

 C mm	 L mm		
		chrom chrome хром	ZnAl
128	166	UZ-CRA14-128	
192	230	UZ-CRA14-192	
320	358	UZ-CRA14-320	

* Produkt dostępny na indywidualne zamówienie / Available for special orders / Товар доступен под заказ

Gatka UZ-CR0*
Knob UZ-CR0*
Ручка UZ-CR0*





	 L mm	 H mm		
gatka knob ручка	30	28,5	chrom chrome хром	ZnAl
	25	23	UZ-CR0333-A1 UZ-CR0333-B1	

* Produkt dostępny na indywidualne zamówienie / Available for special orders / Товар доступен под заказ

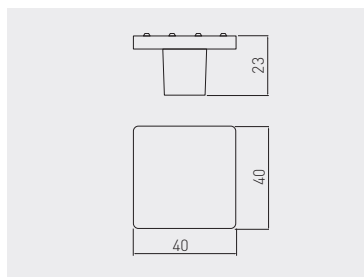
Gatka IZIS*
Knob IZIS*
Ручка IZIS*





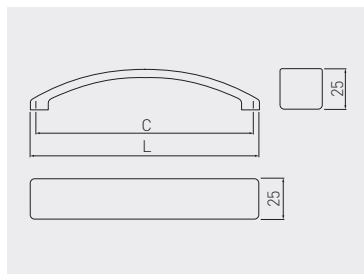

				
gatka knob ручка	40	chrom chrome хром	tytan szczotkowy brushed titanium шлифованный титан	ZnAl
		UZ-IZIS40-01	UZ-IZIS40-11	

* Produkt dostępny na indywidualne zamówienie / Available for special orders / Товар доступен под заказ

Uchwyt ERIS*
Handle ERIS*
Ручка ERIS*





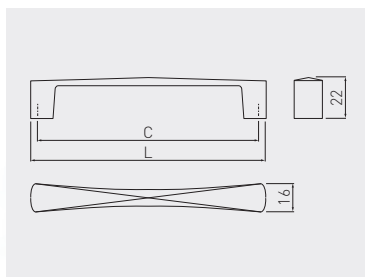

					
	128	142	chrom chrome хром	tytan szczotkowy brushed titanium шлифованный титан	ZnAl
			UZ-ERIS128-01	UZ-ERIS128-11	

* Produkt dostępny na indywidualne zamówienie / Available for special orders / Товар доступен под заказ







Uchwyt COMO
Handle COMO
Ручка COMO

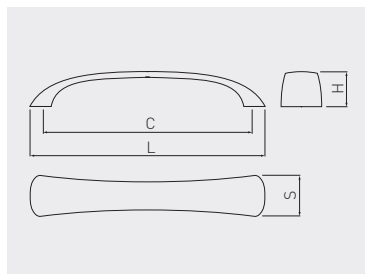

 C mm	 L mm		
		chrom chrome хром	ZnAl
96	104	UZ-COM0096-01	
128	135	UZ-COM0128-01	
160	170	UZ-COM0160-01	





Uchwyt SIENNA
Handle SIENNA
Ручка SIENNA

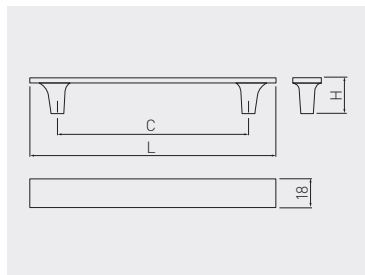

 C mm	 L mm	 H mm	 S mm		
				chrom chrome хром	ZnAl
96	111	21	23,5	UZ-SIENNA096-01	
128	142	23	25	UZ-SIENNA128-01	
160	186	24,5	26,5	UZ-SIENNA160-01	





Uchwyt LUCCA
Handle LUCCA
Ручка LUCCA

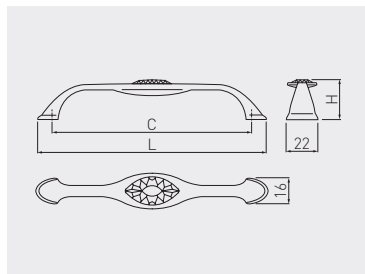

 C mm	 L mm	 H mm		
			chrom chrome хром	ZnAl
96	131	22,5	UZ-LUCCA096-01	
128	163	23	UZ-LUCCA128-01	
160	196	23	UZ-LUCCA160-01	
192	228	23,5	UZ-LUCCA192-01	





Uchwyt BIANCA
Handle BIANCA
Ручка BIANCA

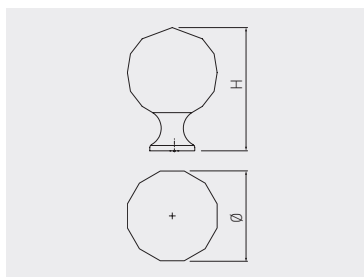

 C mm	 L mm	 H mm		
			chrom chrome хром	ZnAl
96	114	25	UZ-BIANC-96-01	
128	146	26	UZ-BIANC-128-01	





Gatka GZ—CRPA
Knob GZ—CRPA
Ручка GZ—CRPA

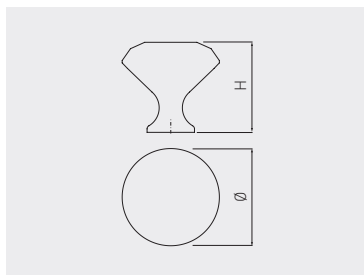

 mm	 mm				
		chrom / biały kryształ chrome / white crystal хром / белый кристалл	chrom / czarny kryształ chrome / black crystal хром / чёрный кристалл	mosiądz / biały kryształ brass / white crystal латунь / белый кристалл	 ZnAl, szkło ZnAl, glass ZnAl, стекло
20	33	GZ-CRPA20-01	GZ-CRPA20-A1	GZ-CRPA20-03	
25	37	GZ-CRPA25-01	GZ-CRPA25-A1	GZ-CRPA25-03	
30	44	GZ-CRPA30-01	GZ-CRPA30-A1	GZ-CRPA30-03	
40	55	GZ-CRPA40-01	GZ-CRPA40-A1	GZ-CRPA40-03	

Gatka GZ—CRPB
Knob GZ—CRPB
Ручка GZ—CRPB



 mm	 mm				
		chrom / biały kryształ chrome / white crystal хром / белый кристалл	chrom / czarny kryształ chrome / black crystal хром / чёрный кристалл	mosiądz / biały kryształ brass / white crystal латунь / белый кристалл	 ZnAl, szkło ZnAl, glass ZnAl, стекло
20	26	GZ-CRPB20-01	GZ-CRPB20-A1	GZ-CRPB20-03	
25	28	GZ-CRPB25-01	GZ-CRPB25-A1	GZ-CRPB25-03	
30	30	GZ-CRPB30-01	GZ-CRPB30-A1	GZ-CRPB30-03	
40	38	GZ-CRPB40-01	GZ-CRPB40-A1	GZ-CRPB40-03	

Gatka GZ—CRPC
 Knob GZ—CRPC
 Ручка GZ—CRPC

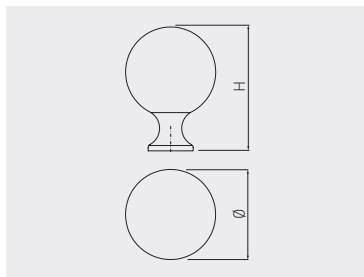

		chrom / biały kryształ chrome / black crystal хром / белый кристалл	chrom / czarny kryształ chrome / black crystal хром / чёрный кристалл	ZnAl, szkło ZnAl, glass ZnAl, стекло
30	43	GZ-CRPC30-01	GZ-CRPC30-A1	
40	54	GZ-CRPC40-01	GZ-CRPC40-A1	



Uchwyt KID WILD Handle KID WILD Ручка KID WILD



UM-KID-I-002



UM-KID-P-001



UM-KID-Q-001



UM-KID-S-001



UM-KID-U-001



UM-KID-Y-001



tygrys / tiger / тигр	UM-KID-I-002	guma, ZnAl rubber, ZnAl резина, ZnAl
stoń / elephant / слон	UM-KID-P-001	
krokodyl / crocodile / крокодил	UM-KID-Q-001	
hipopotam / hippo / бегемот	UM-KID-S-001	
panda / panda / панда	UM-KID-U-001	
pingwin / penguin / пингвин	UM-KID-Y-001	

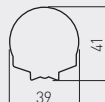
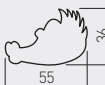

Uchwyt KID PLAY Handle KID PLAY Ручка KID PLAY



UM-KID-C-001



UM-KID-G-001



UM-KID-E-001



UM-KID-D-001



UM-KID-F-001



kwiatek / flower / цветок	UM-KID-C-001	guma, ZnAl rubber, ZnAl резина, ZnAl
kwiatek / flower / цветок	UM-KID-G-001	
samochód / car / автомобиль	UM-KID-D-001	
piłka / ball / мяч	UM-KID-E-001	
kwadrat / square / квадрат	UM-KID-F-001	

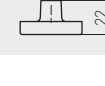
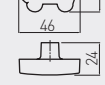
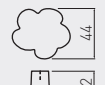

Uchwyt KID FARM
Handle KID FARM
Ручка KID FARM



UM-KID-A-001



UM-KID-B-001



UM-KID-I-001



UM-KID-O-001



UM-KID-T-001



UM-KID-W-001



UM-KID-X-001



UM-KID-Z-001



rybka / fish / рыба	UM-KID-A-001	guma, ZnAl rubber, ZnAl резина, ZnAl
ślimak / snail / улитка	UM-KID-B-001	
kotek / kitten / котенок	UM-KID-I-001	
kura / hen / курица	UM-KID-O-001	
krówka / cow / корова	UM-KID-T-001	
konik / horse / лошадь	UM-KID-W-001	
królik / rabbit / кролик	UM-KID-X-001	
piesek / dog / собака	UM-KID-Z-001	

Chcesz sprawdzić jak wygląda uchwyt na frontach mebli przed zakupem? Do you want to check how your piece of furniture will look with GTV handles? Хочешь проверить как будут смотреться ручки GTV в интерьере?

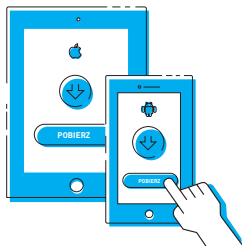

1

KROK

Ściągnij i zainstaluj aplikację ze strony: www.uchwyty.gtv.com.pl lub ze sklepów googleplay i appstore – aplikacja **VIEW AT HOME**.

STEP

Download and install the app for the site: www.uchwyty.gtv.com.pl or from the google play store or appstore – the app is called **VIEW AT HOME**.

ШАГ

Скачай и установи бесплатное приложение с www.uchwyty.gtv.com.pl для смартфонов с операционной системой Android и IOS – приложение **VIEW AT HOME**.

↓ Pobierz za darmo
Download for free
Скачайте бесплатно



Uruchom aplikację
Start the app
Запустите приложение

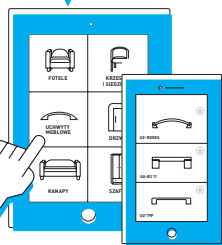

2

KROK

Wybierz kategorię uchwytów meblowych i dobierz odpowiedni model uchwytu.

STEP

Select the category of furniture handles and select desired model.

ШАГ

Выберите категорию лицевой фурнитуры и выберите модель ручки.

Wyświetl uchwyt
Display a handle
Посмотреть

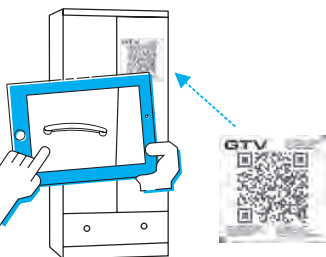

3

KROK

Naklej marker na froncie mebla, skieruj kamerę urządzenia na marker i zobacz jak wygląda wybrany uchwyt na meblu.

STEP

Attach the marker on the furniture front, direct the device's camera onto the marker and see how the selected handle looks on the furniture front.

ШАГ

Прикрепите конфигуратор к мебельному фасаду. Направьте камеру на конфигуратор. Проверьте как ручка смотрится в интерьере.



Wytnij poniższy marker
Cut out the marker below
Вырежьте конфигурактор

GTV

1. ŚCIĄGNIJ I ZAINSTALUJ APLIKACJĘ ZE STRONY
2. WYBIERZ KATEGORIĘ UCHWYTÓW MEBLOWYCH
3. DOBIERZ ODPOWIADAJĄCY CI MODEL
4. NAKLEJ ZNACZNIK NA FRONCIE MEBLA I ZAARANŻUJ GO WYBRANYM UCHWYTEM

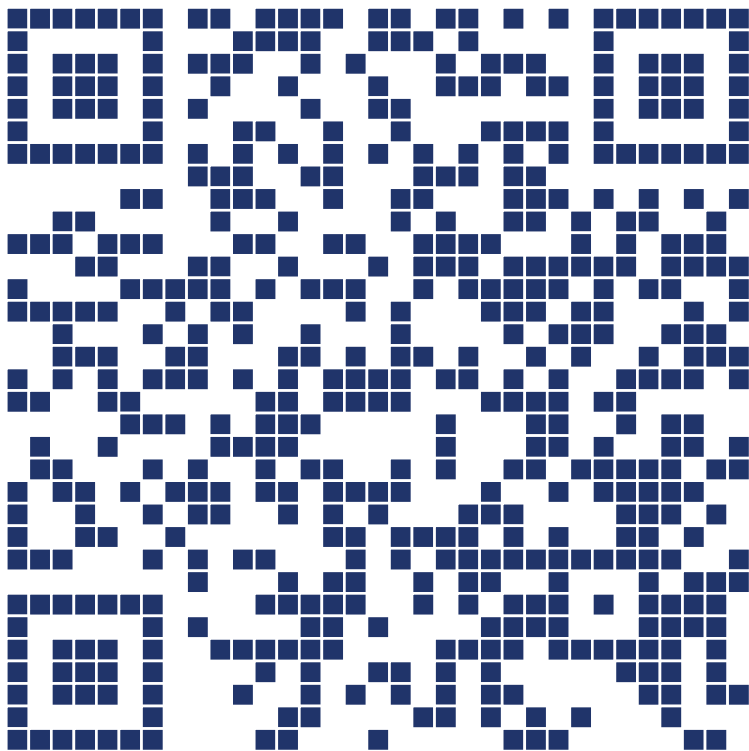

1. DOWNLOAD AND INSTALL APP FORM THE WEBSITE
2. CHOOSE A CATEGORY OF FURNITURE HANDLES
3. SELECT THE DESIRED FURNITURE HANDLE MODEL
4. STICK THE MARKER ON THE FRONT PANEL OF YOUR FURNITURE PIECE, ARRANGE IT WITH YOUR SELECTED HANDLE

1. СКАЧАЙТЕ И УСТАНОВИТЕ ПРОГРАММУ НА СМАРТФОН ИЛИ ПЛАНШЕТ
2. ВЫБЕРИТЕ ИНТЕРЕСУЮЩУЮ ВАС КАТЕГОРИЮ
3. ВЫБЕРИТЕ ПОНРАВИВШУЮСЯ ВАМ РУЧКУ
4. ПРИКРЕПИТЕ КОНФИГУРАТОР К МЕБЕЛЬНОМУ ФАСАДУ И ПРОВЕРЬТЕ КАК РУЧКА СМОТРИТСЯ В ИНТЕРЬЕРЕ

Wieszak SOLO*
 Hook SOLO*
 Крючок SOLO*

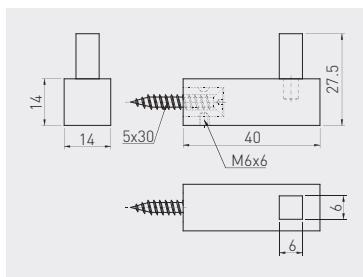

WS-SOLO-14-06



stal szczotkowana / brushed steel / шлифованная сталь



stal / steel / сталь

*Dostępny na zamówienie / Available only for individual order / Доступен под заказ

Wieszak QUADRO*
 Hook QUADRO*
 Крючок QUADRO*

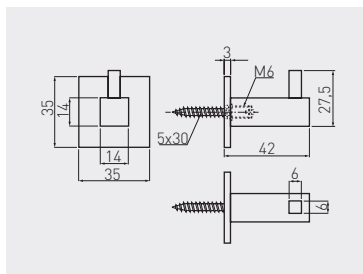

WS-QUAD-14-06



stal szczotkowana / brushed steel / шлифованная сталь



stal / steel / сталь

*Dostępny na zamówienie / Available only for individual order / Доступен под заказ

Wieszak RONDO*
Hook RONDO*
Крючок RONDO*

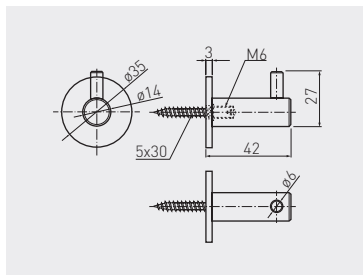

WS-ROND-14-06



stal szczotkowana / brushed steel / шлифованная сталь



stal / steel / сталь

*Dostępny na zamówienie / Available only for individual order / Доступен под заказ

Wieszak 804
Hook 804
Крючок 804

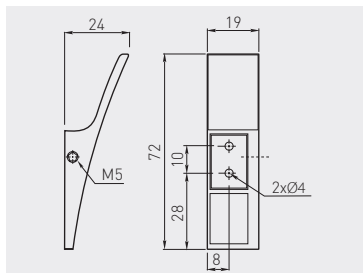

WZ-804-20-01

chrom / chrome / хром

WZ-804-20-05

aluminium / aluminium / алюминий

WZ-804-20-06

stal szczotkowana / brushed steel / шлифованная сталь



ZnAl

Wieszak TOLEDO A0
Hook TOLEDO A0
Крючок TOLEDO A0

MODERN

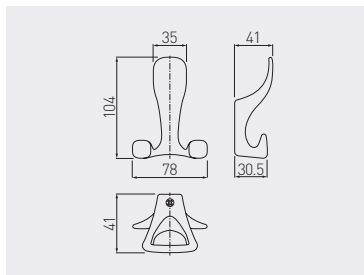

WZ-TOLED-A0-01	chrom / chrome / хром	ZnAl
WZ-TOLED-A0-02	satyna / satin / сатин	
WZ-TOLED-A0-05	aluminium / aluminium / алюминий	
WZ-TOLED-A0-06	stal szcztokowana / brushed steel / шлифованная сталь	

Wieszak TOLEDO B0
Hook TOLEDO B0
Крючок TOLEDO B0

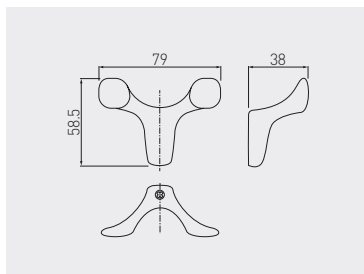

WZ-TOLED-B0-01	chrom / chrome / хром	ZnAl
WZ-TOLED-B0-02	satyna / satin / сатин	
WZ-TOLED-B0-05	aluminium / aluminium / алюминий	
WZ-TOLED-B0-06	stal szcztokowana / brushed steel / шлифованная сталь	

Wieszak TOLEDO C0
 Hook TOLEDO C0
 Крючок TOLEDO C0

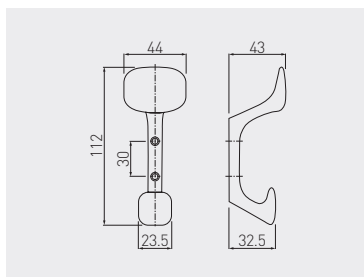

WZ-TOLED-C0-01	chrom / chrome / хром	ZnAl
WZ-TOLED-C0-02	satyna / satin / сатин	
WZ-TOLED-C0-05	aluminium / aluminium / алюминий	
WZ-TOLED-C0-06	stal szczotkowana / brushed steel / шлифованная сталь	



Wieszak K2201
Hook K2201
Крючок K2201

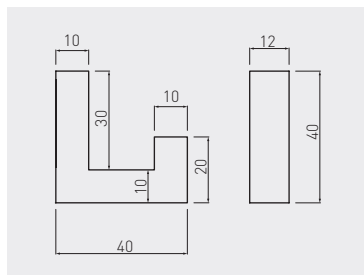

WZ-K2201-01	chrom / chrome / хром	ZnAl
WZ-K2201-06	stal szczotkowana / brushed steel / шлифованная сталь	
WZ-K2201-CZ	czarny / black / чёрный	
WZ-K2201-ZL	zielony / green / зелёный	
WZ-K2201-NB	niebieski / blue / синий	
WZ-K2201-PM	pomarańczowy / orange / оранжевый	
WZ-K2201-RZ	różowy / pink / розовый	
WZ-K2201-CS	kremowy / creamy / кремовый	

Wieszak K2202
Hook K2202
Крючок K2202

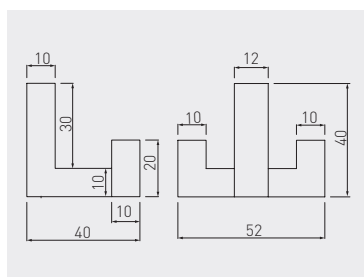

WZ-K2202-01	chrom / chrome / хром	ZnAl
WZ-K2202-06	stal szczotkowana / brushed steel / шлифованная сталь	
WZ-K2202-CZ	czarny / black / чёрный	
WZ-K2202-ZL	zielony / green / зелёный	
WZ-K2202-NB	niebieski / blue / синий	
WZ-K2202-PM	pomarańczowy / orange / оранжевый	
WZ-K2202-RZ	różowy / pink / розовый	
WZ-K2202-CS	kremowy / creamy / кремовый	

Wieszak K23-A0
Hook K23-A0
Крючок K23-A0

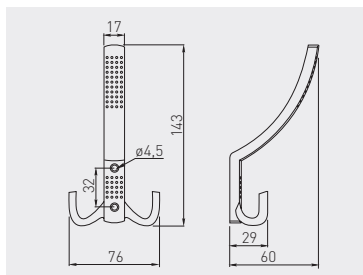

WZ-A0-K23-01	chrom / chrome / хром	ZnAl
WZ-A0-K23-02	satyna / satin / сатин	
WZ-A0-K23-03	mosiądz / brass / латунь	
WZ-A0-K23-04	antyczny mosiądz / antique brass / античная латунь	
WZ-A0-K23-05	aluminium / aluminium / алюминий	
WZ-A0-K23-20	czarny mat / black matt / чёрный матовый	

Wieszak K23-B0
Hook K23-B0
Крючок K23-B0

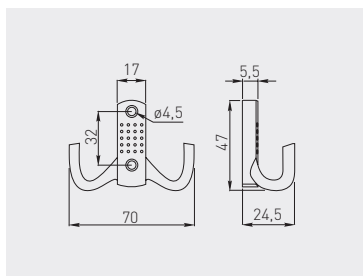

WZ-B0-K23-01	chrom / chrome / хром	ZnAl
WZ-B0-K23-02	satyna / satin / сатин	
WZ-B0-K23-03	mosiądz / brass / латунь	
WZ-B0-K23-04	antyczny mosiądz / antique brass / античная латунь	
WZ-B0-K23-05	aluminium / aluminium / алюминий	
WZ-B0-K23-20	czarny mat / black matt / чёрный матовый	

Wieszak K23-D1*
Hook K23-D1*
Крючок K23-D1*

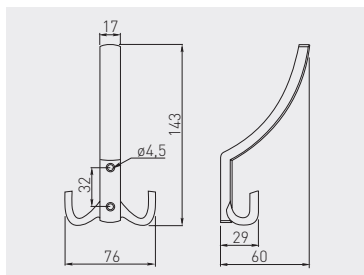

WZ-K23-D1-01	chrom / chrome / хром	ZnAl
WZ-K23-D1-02	satyna / satin / сатин	
WZ-K23-D1-03	mosiądz / brass / латунь	
WZ-K23-D1-05	aluminium / aluminium / алюминий	
WZ-K23-D1-06	stal szczotkowana / brushed steel / шлифованная сталь	

*Dostępny na zamówienie / Available only for individual order / Доступен под заказ

Wieszak K23-E1*
Hook K23-E1*
Крючок K23-E1*

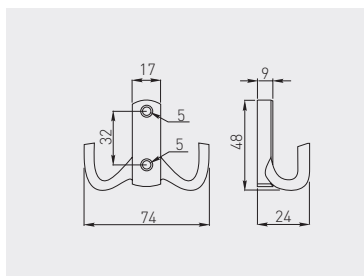

WZ-K23-E1-01	chrom / chrome / хром	ZnAl
WZ-K23-E1-02	satyna / satin / сатин	
WZ-K23-E1-03	mosiądz / brass / латунь	
WZ-K23-E1-05	aluminium / aluminium / алюминий	
WZ-K23-E1-06	stal szczotkowana / brushed steel / шлифованная сталь	

*Dostępny na zamówienie / Available only for individual order / Доступен под заказ

Wieszak K24-A0
Hook K24-A0
Крючок K24-A0

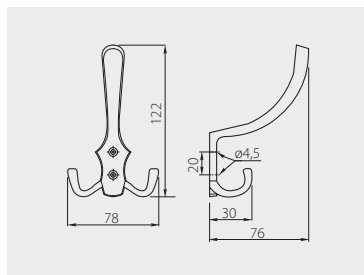

WZ-A0-K24-01	chrom / chrome / хром	ZnAl
WZ-A0-K24-02	satyna / satin / сатин	
WZ-A0-K24-03	mosiądz / brass / латунь	
WZ-A0-K24-04	antyczny mosiądz / antique brass / античная латунь	
WZ-A0-K24-05	aluminium / aluminium / алюминий	
WZ-A0-K24-20	czarny mat / black matt / чёрный матовый	

Wieszak K24-B0
Hook K24-B0
Крючок K24-B0

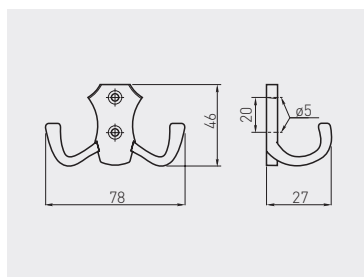

WZ-B0-K24-01	chrom / chrome / хром	ZnAl
WZ-B0-K24-02	satyna / satin / сатин	
WZ-B0-K24-03	mosiądz / brass / латунь	
WZ-B0-K24-04	antyczny mosiądz / antique brass / античная латунь	
WZ-B0-K24-05	aluminium / aluminium / алюминий	
WZ-B0-K24-20	czarny mat / black matt / чёрный матовый	

Wieszak K24-C0
Hook K24-C0
Крючок K24-C0

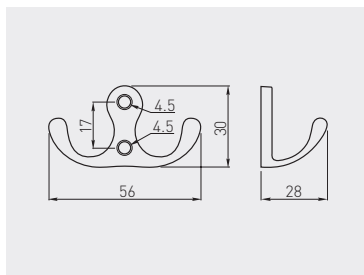

WZ-C0-K24-01	chrom / chrome / хром	ZnAl
WZ-C0-K24-02	satyna / satin / сатин	
WZ-C0-K24-03	mosiądz / brass / латунь	
WZ-C0-K24-04	antyczny mosiądz / antique brass / античная латунь	
WZ-C0-K24-05	aluminium / aluminium / алюминий	
WZ-C0-K24-20	czarny mat / black matt / чёрный матовый	

Wieszak MALAGA A0
Hook MALAGA A0
Крючок MALAGA A0

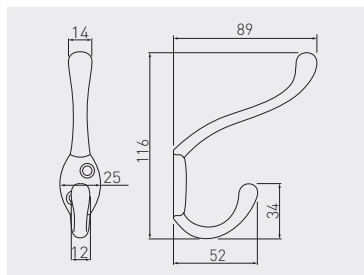

WA-MALAG-A0-01	chrom / chrome / хром	aluminium / aluminium / алюминий
WA-MALAG-A0-02	satyna / satin / сатин	
WA-MALAG-A0-05	aluminium / aluminium / алюминий	
WA-MALAG-A0-20	czarny / black / чёрный	

Wieszak MALAGA B0
Hook MALAGA B0
Крючок MALAGA B0

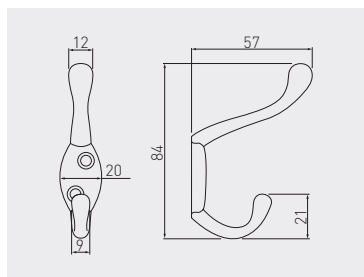

WA-MALAG-B0-01	chrom / chrome / хром	aluminium / aluminium / алюминий
WA-MALAG-B0-02	satyna / satin / сатин	
WA-MALAG-B0-05	aluminium / aluminium / алюминий	
WA-MALAG-B0-20	czarny / black / чёрный	

Wieszak MALAGA C0
Hook MALAGA C0
Крючок MALAGA C0

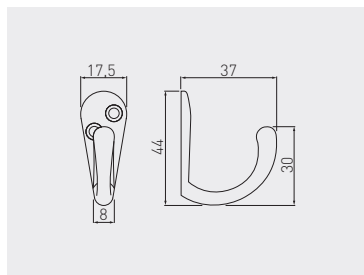

WZ-MALAG-C0-01	chrom / chrome / хром	ZnAl
WZ-MALAG-C0-02	satyna / satin / сатин	
WZ-MALAG-C0-05	aluminium / aluminium / алюминий	
WZ-MALAG-C0-20	czarny / black / чёрный	

Wieszak E18
Hook E18
Крючок E18

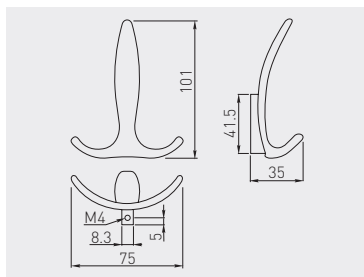

WZ-E-018-01	chrom / chrome / хром	ZnAl
WZ-E-018-02	satyna / satin / сатин	
WZ-E-018-05	aluminium / aluminium / алюминий	
WZ-E-018-06	stal szcztokowana / brushed steel / шлифованная сталь	

Wieszak D892
Hook D892
Крючок D892

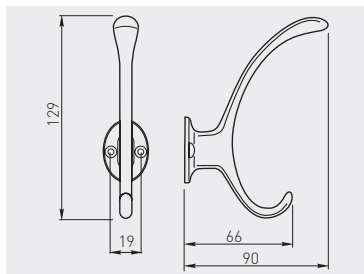

WZ-D-892-02	satyna / satin / сатин	ZnAl
WZ-D-892-05	aluminium / aluminium / алюминий	

Wieszak ORVIETO A0
 Hook ORVIETO A0
 Крючок ORVIETO A0

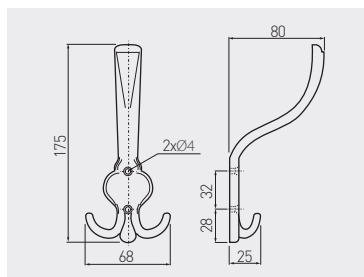

WZ-ORVIE-A0-09



antyczny mosiądz szczotkowany
 antique brushed brass
 античная шлифованная латунь



ZnAl

Wieszak ORVIETO B0
 Hook ORVIETO B0
 Крючок ORVIETO B0

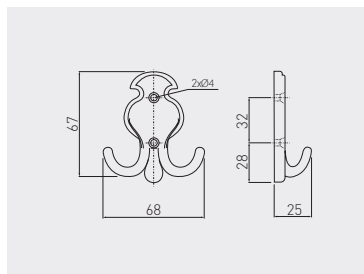

WZ-ORVIE-B0-09



antyczny mosiądz szczotkowany
 antique brushed brass
 античная шлифованная латунь



ZnAl

Wieszak K24
Hook K24
Крючок K24

RETRO

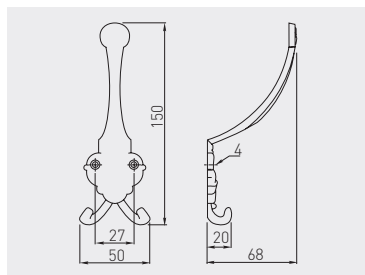

WZ-00-K24-04





antyczny mosiądz / antique brass / античная латунь

ZnAl

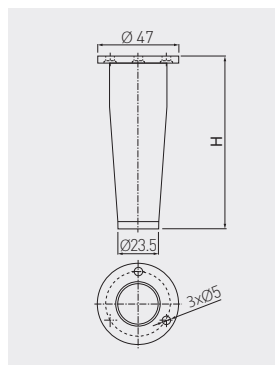

Nóżka B-103
Leg B-103
Ножка B-103



		 H mm		
NM-B103-80-01		80	chrom / chrome / хром	ZnAl
NM-B103-80-06			stal szczotkowana / brushed steel / шлифованная сталь	
NM-B103-100-01		100	chrom / chrome / хром	
NM-B103-100-06			stal szczotkowana / brushed steel / шлифованная сталь	
NM-B103-120-01		120	chrom / chrome / хром	
NM-B103-120-06			stal szczotkowana / brushed steel / шлифованная сталь	

Nóżka BD-150 z regulacją
Adjustable leg BD-150
Ножка BD-150 с регулировкой

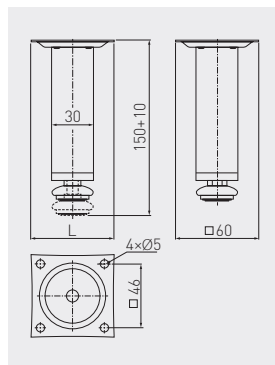



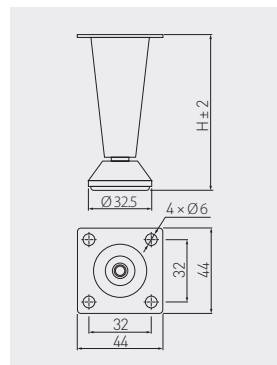

		 H mm		
NM-BD-150-01		150 + 10	chrom / chrome / хром	stal / steel / сталь
NM-BD-150-02			satyna / satin / сатин	

Nóżka RIO z regulacją
Adjustable leg RIO
Ножка RIO с регулировкой





NEW

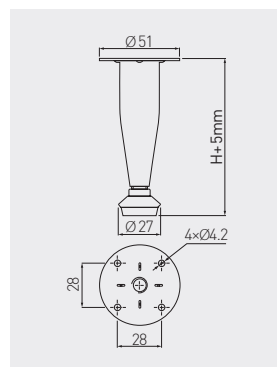

	 H mm		
NM-RIO-050-01	50 +/- 2		
NM-RIO-080-01	80 +/- 2		
NM-RIO-100-01	100 +/- 2		

Nóżka BD-03 z regulacją
Adjustable leg BD-03
Ножка BD-03 с регулировкой



	 H mm		
NM-BD-003-01	100 + 5	chrom / chrome / хром	
NM-BD-003-02		satyna / satin / сатин	
NM-BD-003-150-01	150 + 5	chrom / chrome / хром	
NM-BD-003-150-02		satyna / satin / сатин	

Nóżka BD-780
Leg BD-780
Ножка BD-780

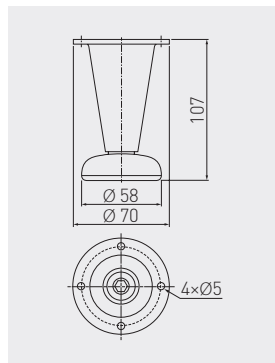

NM-BD-780-M1	107	chrom / chrome / хром	stal / steel / сталь
NM-BD-780-M2		satyna / satin / сатин	
NM-BD-780-M5		aluminium / aluminium / алюминий	

Nóżka B-140
Leg B-140
Ножка B-140

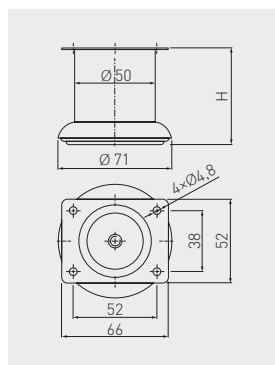



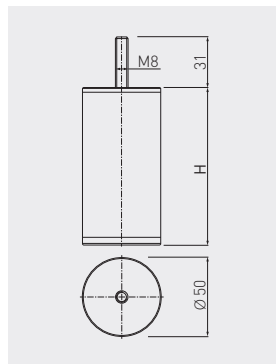

NM-B-140-060	60	chrom chrome хром	stal, tworzywo steel, plastic сталь, пластмасса
NM-B-140-080	80		
NM-B-140-100	100		
NM-B-140-120*	120		
NM-B-140-150*	150		
NM-B-140-180*	180		
NM-B-140-200*	200		

* Dostępny na zamówienie / Available only for individual order / Доступен под заказ





Nóżka STR-50
Leg STR-50
Ножка STR-50

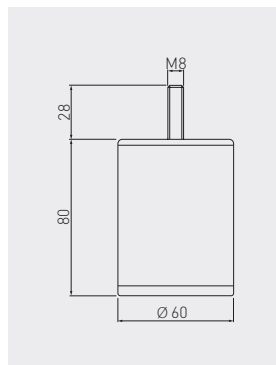

		 H mm		
NM-STR50-100-01		100	chrom chrome хром	stal, tworzywo steel, plastic сталь, пластмасса
NM-STR50-120-01		120		
NM-STR50-150-01		150		





Nóżka STR-60
Leg STR-60
Ножка STR-60

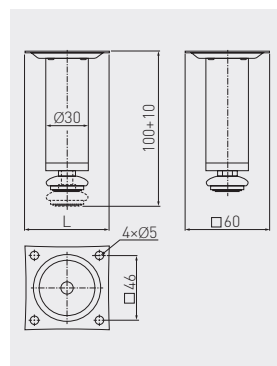

		 H mm		
NM-STR60-80-01		80	chrom chrome хром	stal, tworzywo steel, plastic сталь, пластмасса





Nózka BD-100 z regulacją
Adjustable leg BD-100
Ножка BD-100 с регулировкой

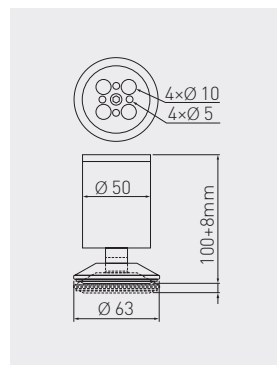

		 H mm		
NM-BD-100-01		100 + 10	chrom / chrome / хром	stal / steel / сталь
NM-BD-100-02			satyna / satin / сатин	
NM-BD-100-05			aluminium / aluminium / алюминий	
NM-BD-100-06			stal szcztokowana / brushed steel / шлифованная сталь	

Nózka BD-762 z regulacją
Adjustable leg BD-762
Ножка BD-762 с регулировкой



		 H mm		
NM-BD-762-01		100 + 8	chrom / chrome / хром	ZnAl, stal / ZnAl, steel / ZnAl, сталь
NM-BD-762-05			aluminium / aluminium / алюминий	

Nóżka BD-867
Leg BD-867
Ножка BD-867

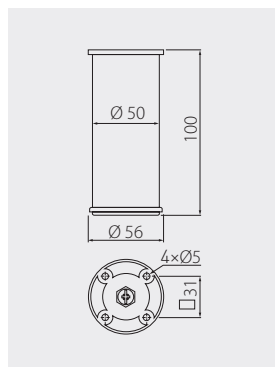

NM-BD867-100	100	aluminium / aluminium / алюминий	aluminium / aluminium / алюминий
--------------	-----	----------------------------------	----------------------------------

Nóżka BD-868
Leg BD-868
Ножка BD-868

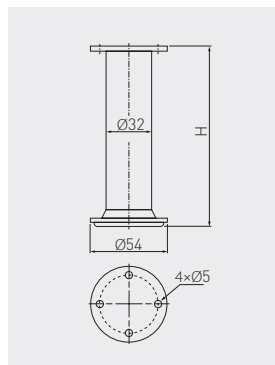

NM-BD868-100	100	aluminium / aluminium / алюминий	aluminium / aluminium / алюминий
NM-BD868-150	150		



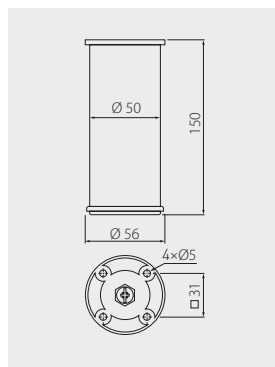

Nóżka BD-869
Leg BD-869
Ножка BD-869

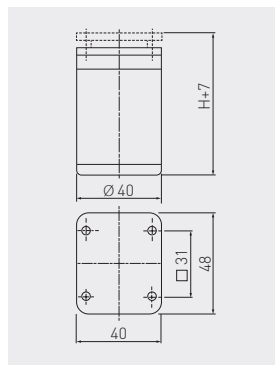

	 H mm		
NM-BD869-150	150	aluminium / aluminium / алюминий	aluminium / aluminium / алюминий



Nóżka DAP-77 z regulacją
Adjustable leg DAP-77
Ножка DAP-77 с регулировкой высоты

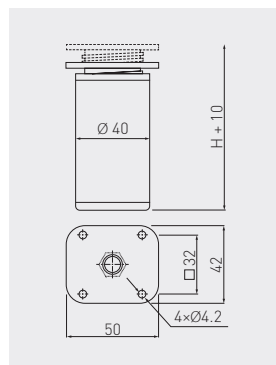

	 H mm		
NM-DAP77-60	60 + 7	aluminium / aluminium / алюминий	aluminium, tworzywo aluminium, plastic алюминий, пластмасса
NM-DAP77-100	100 + 7		
NM-DAP77-150	150 + 7		

Nóżka NAC z regulacją*
Adjustable leg NAC*
Ножка NAC с регулировкой высоты*



	 H mm		
NM-NAC-27651-06	60 + 10	chrom chrome хром	aluminium, tworzywo aluminium, plastic алюминий, пластмасса
NM-NAC-27651-10	100 + 10		
NM-NAC-27651-15	150 + 10		

* Dostępny na zamówienie / Available only for individual order / Доступен под заказ

Nóżka BAHIA
Leg BAHIA
Ножка BAHIA



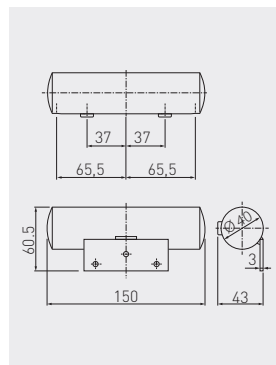

NEW

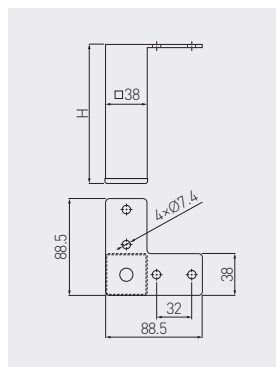

	 H mm		
NM-BAHIA40-150-01	43	chrom / chrome / хром	stal, tworzywo steel, plastic сталь, пластмасса

Nóżka B-104
Leg B-104
Ножка B-104



		 H mm		
NM-B104-100-01		100	chrom / chrome / хром	stal / steel / сталь
NM-B104-150-01		150		
NM-B104-200-01		200		

Nóżka SQ-40 z regulacją
Adjustable leg SQ-40
Ножка SQ-40 с регулировкой высоты

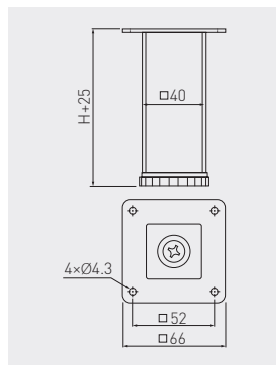

		 H mm		
NM-SQ40ADJ-060		60 + 25	chrom / chrome / хром	stal / steel / сталь
NM-SQ40ADJ-100		100 + 25		

Nóżka SQA z regulacją
Adjustable leg SQA
Ножка SQA с регулировкой высоты

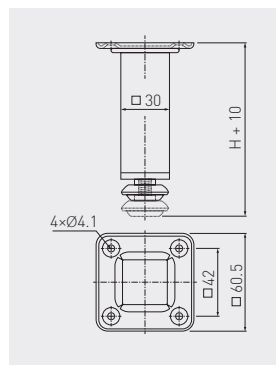

NM-SQA100-01	100 + 10	chrom / chrome / хром	stal / steel / сталь
NM-SQA150-01*	150 + 10		

*Dostępny na zamówienie / Available only for individual order / Доступен под заказ

Nóżka BD-727
Leg BD-727
Ножка BD-727

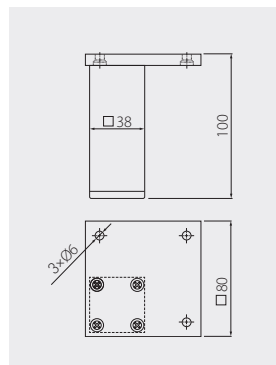

NM-BD727-100	100	aluminium / aluminium / алюминий	aluminium / aluminium / алюминий
--------------	-----	----------------------------------	----------------------------------

Nóżka BD-739
Leg BD-739
Ножка BD-739

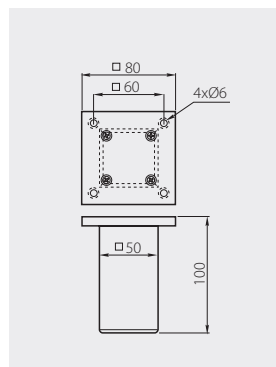

NM-BD-739-05	100	aluminium / aluminium / алюминий	aluminium / aluminium / алюминий
--------------	-----	----------------------------------	----------------------------------

Nóżka DAK-27 z regulacją
Adjustable leg DAK-27
Ножка DAK-27 с регулировкой высоты

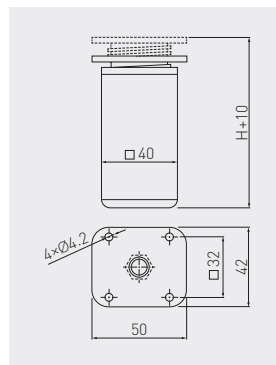

NM-DAK27-060	60 + 10	aluminium aluminium алюминий	aluminium, tworzywo aluminium, plastic алюминий, пластмасса
NM-DAK27-080	80 + 10		
NM-DAK27-100	100 + 10		
NM-DAK27-120	120 + 10		
NM-DAK27-150	150 + 10		

Nóżka NACK z regulacją*
Adjustable leg NACK*
Ножка NACK с регулировкой высоты*

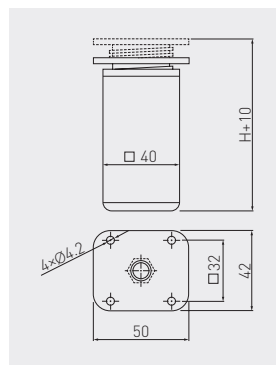

	 H mm		
NM-NACK27651-06	60 + 10	chrom chrome	tworzywo, aluminium plastic, aluminium
NM-NACK27651-10	100 + 10	хром chrome	пластмасса, алюминий

* Dostępny na zamówienie / Available only for individual order / Доступен под заказ

Nóżka TOKYO
Leg TOKYO
Ножка TOKYO

NEW

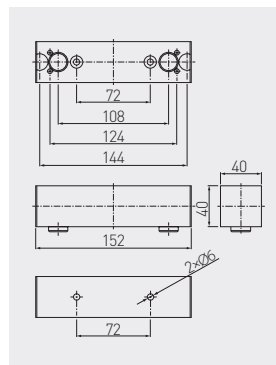

	 H mm		
NM-TOKYO40-150-01	40	chrom / chrome / хром	stal, tworzywo steel, plastic сталь, пластмасса

Nóżka BD-01
Leg BD-01
Ножка BD-01

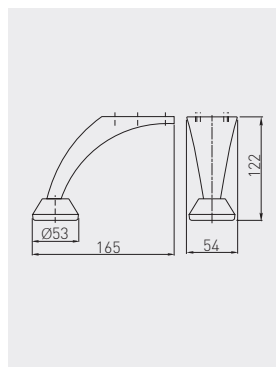

	 mm		
NM-BD-001-M1B	122	chrom / chrome / хром	stal / steel / сталь

Nóżka BD-712
Leg BD-712
Ножка BD-712

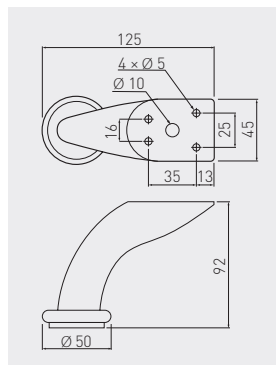

	 mm		
NM-BD-712-M1	92	chrom / chrome / хром	stal / steel / сталь

*Dostępny na zamówienie / Available only for individual order / Доступен под заказ

Nóżka STGC 50
Leg STGC 50
Ножка STGC 50

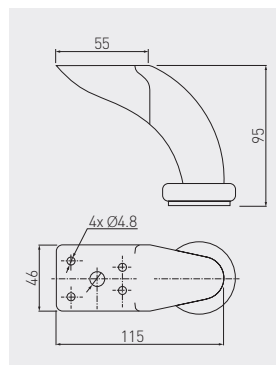

	 mm		
NM-STGC50-95-01	95	chrom / chrome / хром	stal / steel / сталь

Nóżka STGY 135
Leg STGY 135
Ножка STGY 135

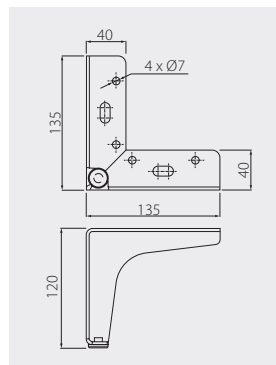

	 mm		
NM-STGY135-100-01	100	chrom / chrome / хром	stal, tworzywo steel, plastic сталь, пластик
NM-STGY135-130-01	130		
NM-STGY135-150-01	150		

Nóżka STGY-135
Leg STGY-135
Ножка STGY-135

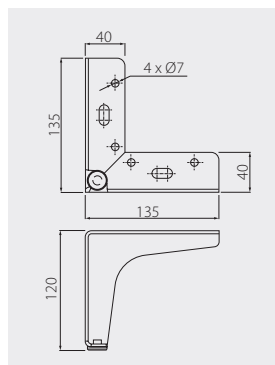

	 H mm		
NM-STGY135-120-01	120	chrom / chrome / хром	stal / steel / сталь

Nóżka STOMP
Leg STOMP
Ножка STOMP

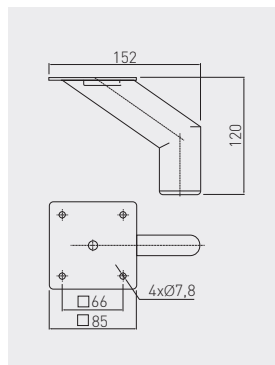

	 H mm		
NM-STOMP-120-20	120	czarny / black / чёрный	stal / steel / сталь

Nóżka STOMP
Leg STOMP
Ножка STOMP

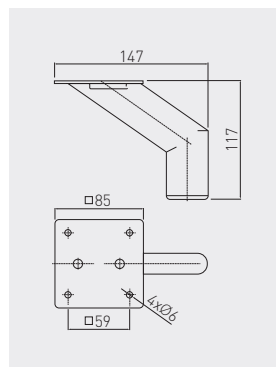

	 H mm		
NM-STOMP-120-01	117	chrom / chrome / хром	stal / steel / сталь

Nóżka STPL 135
Leg STPL 135
Ножка STPL 135

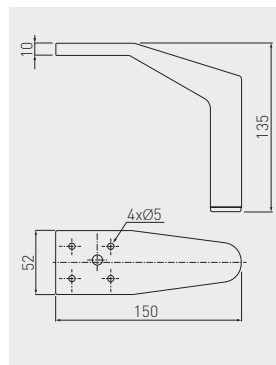

	 H mm		
NM-STPL-135-01	135	chrom / chrome / хром	stal / steel / сталь

Nóżka MDN-D4
Leg MDN-D4
Ножка MDN-D4

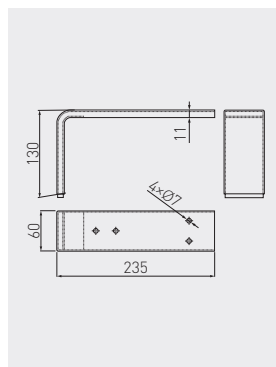

	 H mm		
NM-MDN-D4-01	130	chrom / chrome / хром	stal / steel / сталь

Nóżka XH-30*
Leg XH-30*
Ножка XH-30*

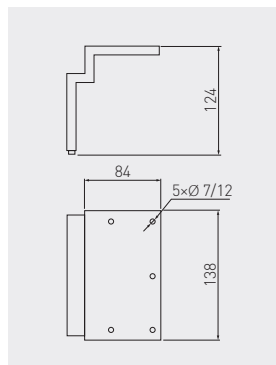

	 H mm		
NM-XH3065-05	124	aluminium / aluminium / алюминий	aluminium / aluminium / алюминий

* Dostępny na zamówienie / Available only for individual order / Доступен под заказ

Nóżka XH-82
Leg XH-82
Ножка XH-82

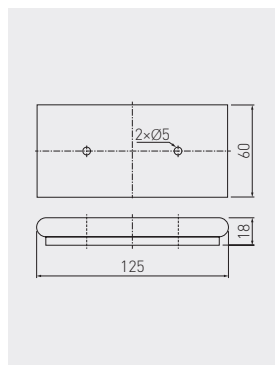

NM-XH8273-01



18



chrom / chrome / хром



ZnAl

Nóżka MDN-926
Leg MDN-926
Ножка MDN-926

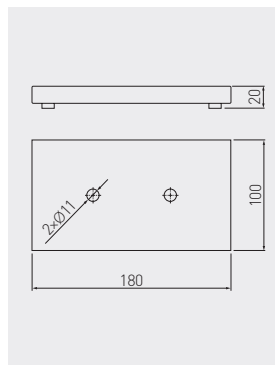

NM-MDN926-01



20



chrom / chrome / хром



stal / steel / сталь

Nózka MDN-927
Leg MDN-927
Ножка MDN-927

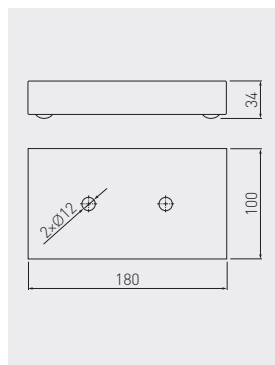

NM-MDN927-01	34	chrom / chrome / хром	stal / steel / сталь
--------------	----	-----------------------	----------------------

Nózka MDN-941
Leg MDN-941
Ножка MDN-941

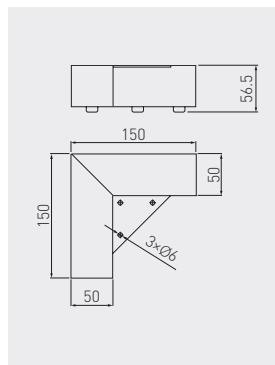

NM-MDN941-01	56	chrom / chrome / хром	stal / steel / сталь
--------------	----	-----------------------	----------------------

Nózka STSL
Leg STSL
Ножка STSL

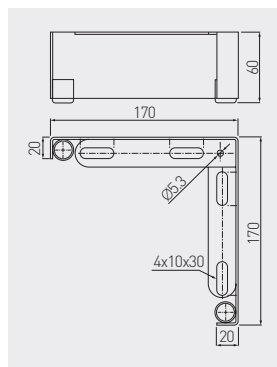

NM-STSL-170-60-01	60	chrom / chrome / хром	stal / steel / сталь
-------------------	----	-----------------------	----------------------





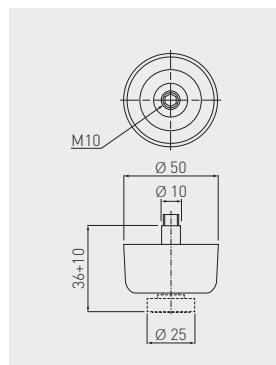

Ślizgacz WPJ z regulacją
Adjustable furniture slider WPJ
Опора WPJ с регулировкой

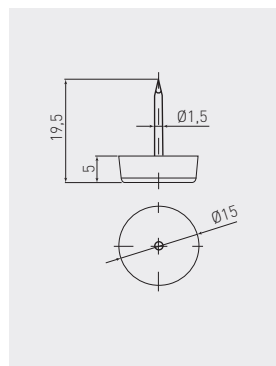

	 mm		
NM-WPJ22-D20	36 + 10	czarny / black / чёрный	tworzywo / plastic / пластмасса

Ślizgacz SLZ pojedynczy
Furniture slider SLZ single
Опора SLZ одинарная



		
BP-SLZIGW-10	czarny / black / чёрный	tworzywo / plastic / пластмасса

Ślizgacz SLZ podwójny
Furniture slider SLZ double
Опора SLZ двойная

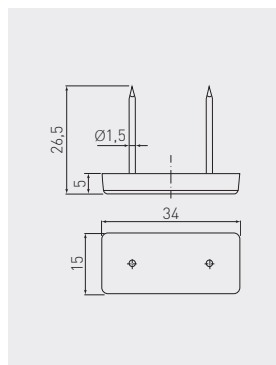

BP-SLZIGW-21



czarny
black
чёрный



tworzywo
plastic
пластмасса

Stopka M6 regulowana
Foot M6 adjustable
Ножка M6 с регулировкой

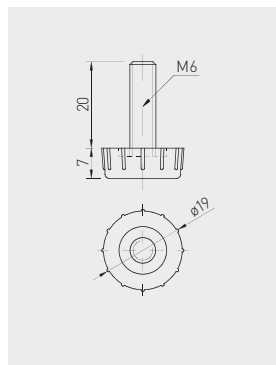

NM-STOPKA-M6



osynek
galvanized
гальваника



stal, tworzywo
steel, plastic
сталь, пластмасса

Stopka M6 regulowana sześciokątna
Foot M6 adjustable hexagonal
Ножка M6 с регулировкой (шестигранная)

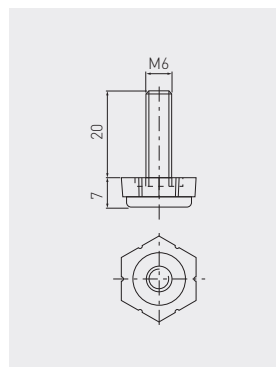

		
NM-STOPKSZESTK-M6	ocynk galvanized гальваника	stal, tworzywo steel, plastic сталь, пластмасса

Mufa M6
Socket M6
Муфта M6







NM-MUFAWB-00

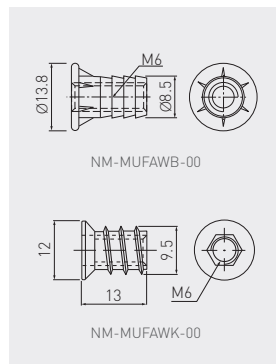

NM-MUFAWK-00



			
NM-MUFAWB-00	wbijana screw-in sleeve врезная	srebrny silver серебряный	ZnAl
NM-MUFAWK-00	wkręcana screwed для вкручивания		

Nóżka DPD z regulacją
Adjustable leg DPD
Ножка DPD с регулировкой

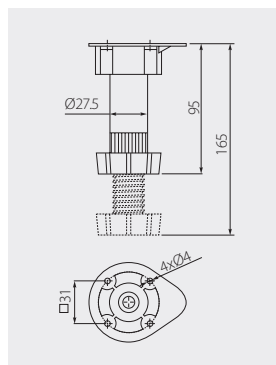

NM-DPD20-100	95 - 165	60	czarny / black / чёрный	tworzywo / plastic / пластмасса
--------------	----------	----	-------------------------	---------------------------------



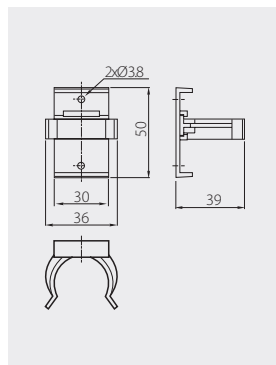



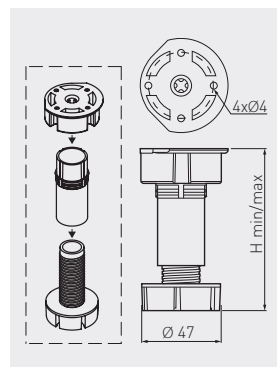

Klip do nóżki DPD
Plinth clip DPD
Клипса к ножке DPD



NM-KL-DPL-20	czarny / black / чёрный	tworzywo / plastic / пластмасса
--------------	-------------------------	---------------------------------

Nóżka DPA
Leg DPA
Ножка DPA



			 H mm	 kg		
NM-DPA20-100	pakowane w karton packing in box картонная упаковка		87 - 120	100		tworzywo plastic пластмасса
NM-DPA20-150			137 - 170			
NM-DPA20-100W	pakowane w worek packing in plastic bag полиэтиленовый пакет		87 - 120			
NM-DPA20-150W			137 - 170			

Klip do nóżki DPA
Plinth clip DPA
Клипса к ножке DPA

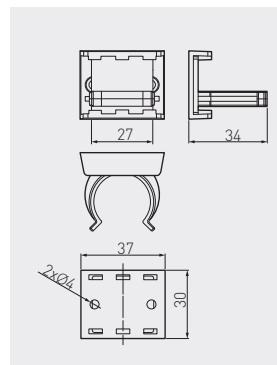

			
NM-KL-DPA-20		czarny / black / чёрный	tworzywo / plastic / пластмасса

Nóżka ML-50 z regulacją
Adjustable leg ML-50
Ножка ML-50 с регулировкой

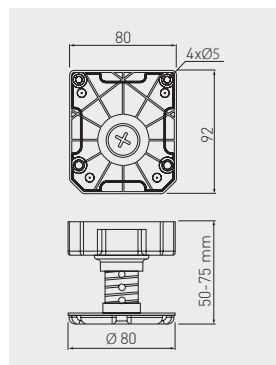

NM-ML-50-75	50-75	450	czarny / black / чёрный	tworzywo / plastic / пластмасса
-------------	-------	-----	-------------------------	---------------------------------

Nóżka ML-65 z regulacją
Adjustable leg ML-65
Ножка ML-65 с регулировкой

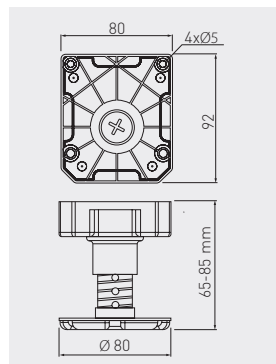

NM-ML-65-85	65-85	450	czarny / black / чёрный	tworzywo / plastic / пластмасса
-------------	-------	-----	-------------------------	---------------------------------

Nóżka ML-85 z regulacją
Adjustable leg ML-85
Ножка ML-85 с регулировкой

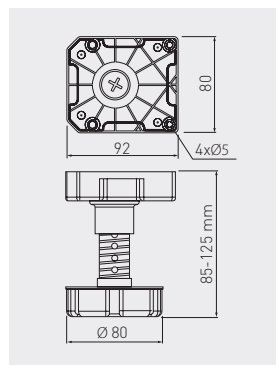

	 H mm	 kg		
NM-ML-85-125	85-125	450	czarny / black / чёрный	tworzywo / plastic / пластмасса

Nóżka ML-95 z regulacją
Adjustable leg ML-95
Ножка ML-95 с регулировкой

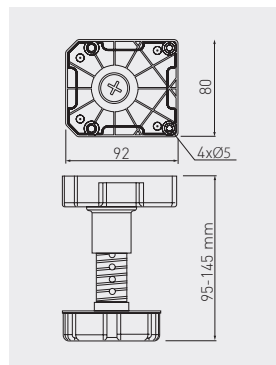

	 H mm	 kg		
NM-ML-95-145	95-145	450	czarny / black / чёрный	tworzywo / plastic / пластмасса

Nóżka ML-125 z regulacją
Adjustable leg ML-125
Ножка ML-125 с регулировкой

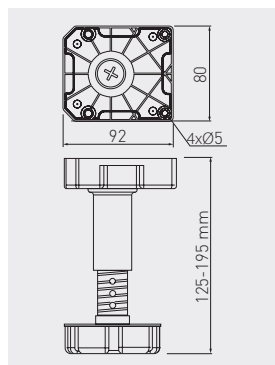

NM-ML-125-195	125-195 mm	450 kg	czarny / black / чёрный	tworzywo / plastic / пластмасса
---------------	---------------	-----------	-------------------------	---------------------------------

Klip do nóżek ML
Clip for ML legs
Клипса к ножке ML

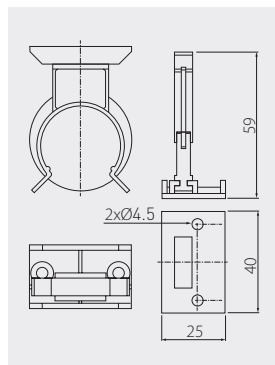

NM-ML-KL	czarny / black / чёрный	tworzywo / plastic / пластмасса
----------	-------------------------	---------------------------------

Mechanizm zapadkowy zagłówek sofy
 Ratchet mechanism of the sofa's bolster
 Механизм трансформации подголовника

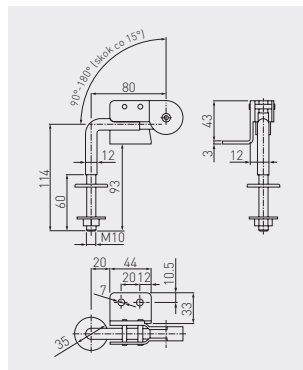

AMS-MPST001-0C



kąt otwarcia 90°-180°
 opening angle 90°-180°
 угол открытия 90°-180°



stal
 steel
 сталь

Mechanizm zapadkowy zagłówek sofy z regulacją
 Ratchet mechanism of the sofa's bolster with adjustment
 Механизм открытия подголовника с регулятором

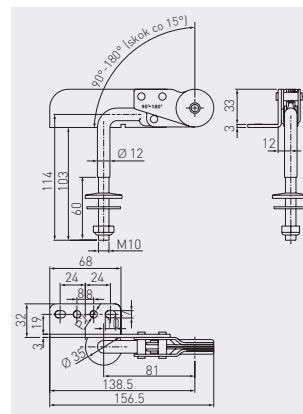

AMS-MPST002-0C



kąt otwarcia 90°-180°
 opening angle 90°-180°
 угол открытия 90°-180°



stal
 steel
 сталь

Mechanizm zapadkowy podłokietnika sofy, z regulacją
 Ratchet mechanism of the sofa's elbow-rest with adjustment
 Механизм трансформации подлокотника, с регулятором

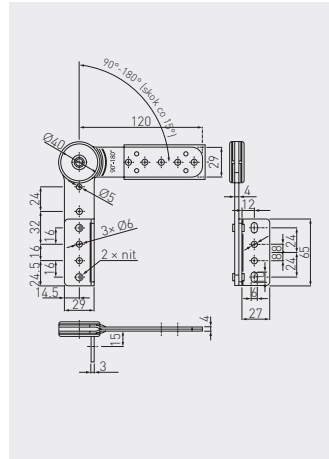

AMS-MPST003-0C





kąt otwarcia 90°-180°
 opening angle 90°-180°
 угол открытия 90°-180°

stal
 steel
 сталь

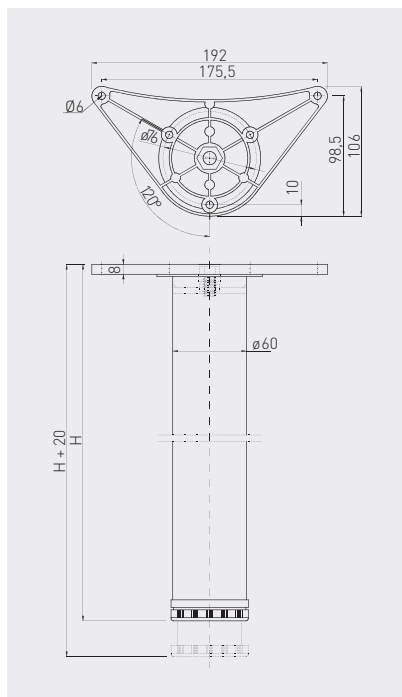

Noga A6 z regulacją
Adjustable leg A6
Опора A6 с регулировкой



		 H mm		
NM-A60710-01	710 + 30		chrom / chrome / хром	
NM-A60710-02			satyna / satin / сатин	
NM-A60710-05			aluminium / aluminium / алюминий	
NM-A60710-10*			biały / white / белый	
NM-A60710-20			czarny / black / чёрный	
NM-A60710-80			srebrny / silver / серебристый	
NM-A60820-01	820 + 30		chrom / chrome / хром	
NM-A60820-02			satyna / satin / сатин	
NM-A60820-05			aluminium / aluminium / алюминий	
NM-A60820-10*			biały / white / белый	
NM-A61100-01	1100 + 30		chrom / chrome / хром	
NM-A61100-02			satyna / satin / сатин	
NM-A61100-05			aluminium / aluminium / алюминий	
NM-A61100-06			stal szczotkowana / brushed steel / шлифованная сталь	
NM-A61100-10*			biały / white / белый	
NM-A61100-20*			czarny / black / чёрный	

* Dostępny na zamówienie / Available only for individual order / Доступен под заказ

Noga G6 z regulacją
Adjustable leg G6
Опора G6 с регулировкой

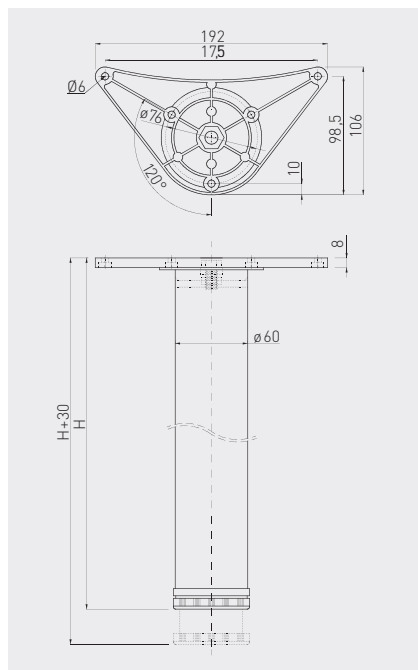

		 H mm		
NM-G60710-01		710 + 30	chrom / chrome / хром	stal, aluminium steel, aluminium сталь, алюминий
NM-G60710-02			satyna / satin / сатин	
NM-G60710-03			mosiądz / brass / латунь	
NM-G60710-05			aluminium / aluminium / алюминий	
NM-G60710-06			stal szczotkowana / brushed steel / шлифованная сталь	
NM-G60710-20			czarny / black / чёрный	
NM-G60710-80		srebrny / silver / серебристый		
NM-G60820-01		820 + 30	chrom / chrome / хром	
NM-G60820-05			aluminium / aluminium / алюминий	
NM-G60820-06			stal szczotkowana / brushed steel / шлифованная сталь	
NM-G60820-20			czarny / black / чёрный	
NM-G61100-01		1100 + 30	chrom / chrome / хром	
NM-G61100-05			aluminium / aluminium / алюминий	
NM-G61100-20			czarny / black / чёрный	

* Na zamówienie dostępna w kolorze białym / For special orders available in white color / Под заказ доступна в белом цвете

Noga S6 z regulacją
Adjustable leg S6
Опора S6 с регулировкой

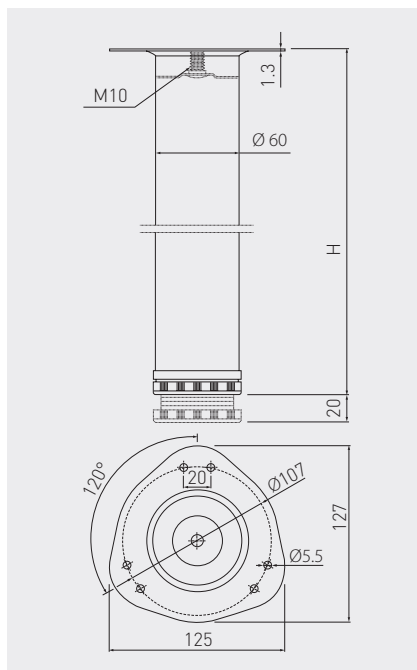

NM-S60710-01 (A)	710 + 20	chrom / chrome / хром	stal / steel / сталь
NM-S60710-02 (A)		satyna / satin / сатин	
NM-S60710-05 (A)		aluminium / aluminium / алюминий	
NM-S60710-10 (A)		biały / white / белый	
NM-S60710-20 (A)		czarny / black / чёрный	
NM-S60820-01 (A)	820 + 20	chrom / chrome / хром	
NM-S60820-02 (A)		satyna / satin / сатин	
NM-S60820-05 (A)		aluminium / aluminium / алюминий	
NM-S60820-10 (A)		biały / white / белый	
NM-S60820-20 (A)		czarny / black / чёрный	

Noga F-50 składana*
 Leg F-50 foldable*
 Складная опора F-50*

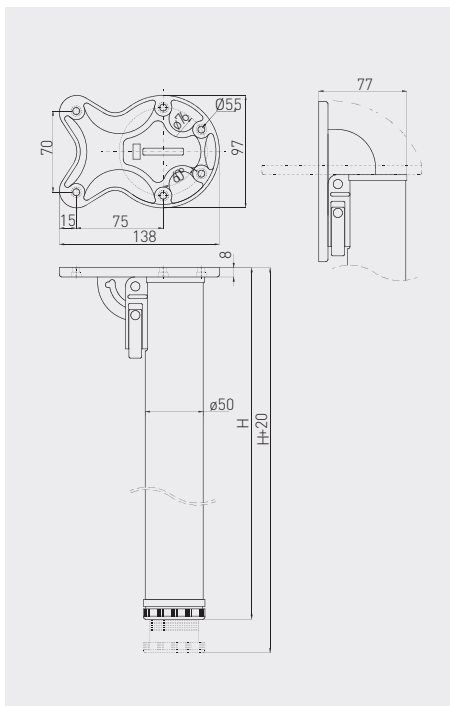



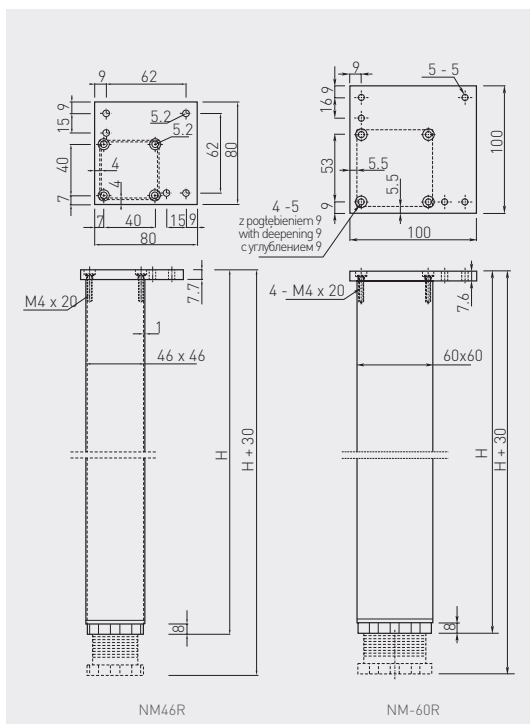
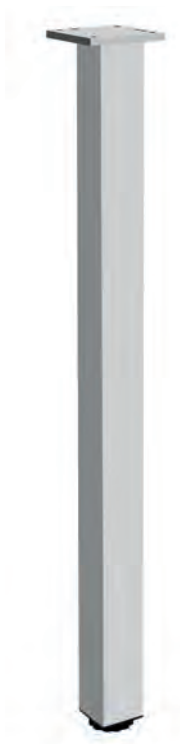

NM-F50710-01	710 + 20	chrom / chrome / хром	ZnAl, stal, ABS ZnAl, steel, ABS ZnAl, сталь, ABS
NM-F50710-06		stal szczotkowana / brushed steel / шлифованная сталь	
NM-F50710-10		biały / white / белый	
NM-F50710-20		czarny / black / чёрный	
NM-F50870-01	870 + 20	chrom / chrome / хром	
NM-F50870-06		stal szczotkowana / brushed steel / шлифованная сталь	
NM-F50870-10		biały / white / белый	
NM-F50870-20		czarny / black / чёрный	

* Dostępny na zamówienie / Available only for individual order / Доступен под заказ

Noga kwadratowa z regulacją
 Square furniture leg
 Мебельная опора с регулировкой



	 H mm		
NM-46R710-05	710 + 30	aluminium / aluminium / алюминий	aluminium aluminium алюминий
NM-46R820-05	820 + 30		
NM-60R710-05	710 + 30		
NM-60R820-05	820 + 30		
NM-60R710-06*	710 + 30	stal szczotkowana / brushed steel / шлифованная сталь	
NM-60R710-20*	710 + 30	czarny / black / чёрный	

* Dostępna na zamówienie / Available only for individual order / Доступен под заказ

* Na indywidualne zamówienie dostępna w wysokości 1100 mm / For special orders 1100 mm height also available
 Под заказ доступна также с высотой 1100 мм

Noga barowa
Bar leg
Барная опора

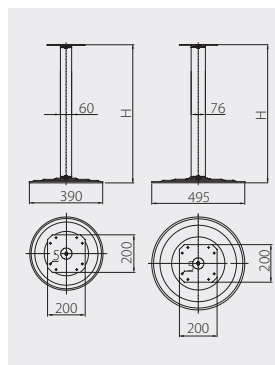

NM-380X730-01	735	60	chrom / chrome / хром	stal / steel / сталь
NM-480X730-01	735	76		

Stelaż biurkowy
Metal frames for desk
Металлический каркас для стола

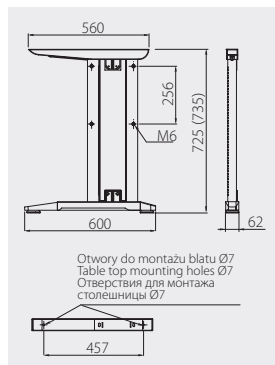

SB-A60X72-80	725 (735)	srebrny / silver/ серебристый	stal / steel / сталь
--------------	-----------	-------------------------------	----------------------

Rolka KM-D20
Furniture caster KM-D20
Колёсики KM-D20

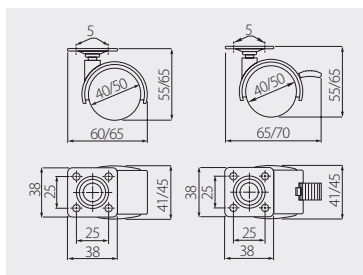

KM-00-40-D20	bez hamulca without break без стопора	40	18	czarny black чёрный	plastik plastic пластмасса
KM-00-50-D20		50	22		
KM-0H-40-D20	z hamulcem with break со стопором	40	18		
KM-0H-50-D20		50	22		

Rolka KM 15 plastikowa
Furniture caster KM 15 plastic
Пластиковые колёсики KM 15

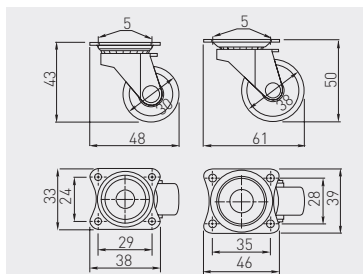

KM-015030-10	30	13,5	biały / white / белый	plastik plastic пластмасса
KM-015030-20	30		czarny / black / чёрный	
KM-015038-10	38	16	biały / white / белый	



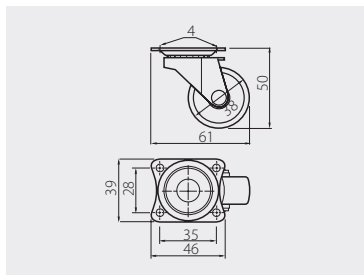



Rolka KM 15 gumowa
 Rubber furniture caster KM 15
 Резиновые колёсики KM 15

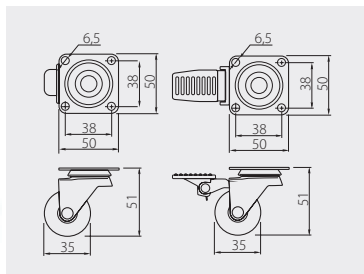

				
KM-015038-GM	38	16	czarny / black / чёрный	guma / rubber / резина





Rolka KMA 35
 Furniture caster KMA 35
 Колёсики KMA 35

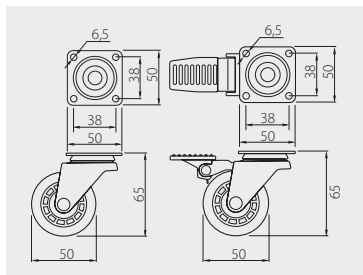

					
KM-A035MM-00	bez hamulca without break без стопора	35	25	przeźroczysty / transparent / прозрачный	PC / PU
KM-A035MM-30				brązowy / brown / коричневый	
KM-AH35MM-00	z hamulcem with break со стопором			przeźroczysty / transparent / прозрачный	
KM-AH35MM-30				brązowy / brown / коричневый	





Rolka KMA 50
Furniture caster KMA 50
Колёсики KMA 50

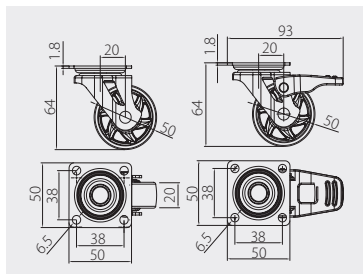

					
KM-A050MM-00	bez hamulca without break	50	35	przeźroczysty / transparent / прозрачный	PC / PU
KM-A050MM-30	bez stopopa			brąz / brown / коричневый	
KM-AH50MM-00	z hamulcem with break			przeźroczysty / transparent / прозрачный	
KM-AH50MM-30	so stopopom			brąz / brown / коричневый	





Rolka SHIFT 50
Furniture caster SHIFT 50
Колёсики SHIFT 50

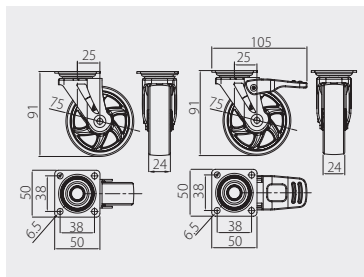

					
KM-B050MM-00	bez hamulca without break	50	30	przeźroczysty / transparent / прозрачный	PC / PU
KM-B050MM-30	bez stopopa			brąz / brown / коричневый	
KM-BH50MM-00	z hamulcem with break			przeźroczysty / transparent / прозрачный	
KM-BH50MM-30	so stopopom			brąz / brown / коричневый	





Rolka SHIFT 75
Furniture caster SHIFT 75
Колёсики SHIFT 75

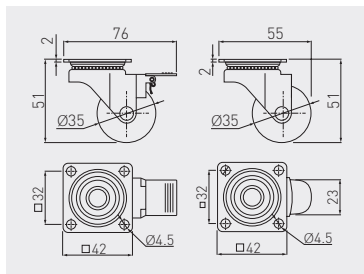

					
KM-B075MM-00	bez hamulca without break без стопора	75	40	przeźroczysty / transparent / прозрачный	PC / PU
KM-B075MM-30				brąz / brown / коричневый	
KM-BH75MM-00	z hamulcem with break со стопором			przeźroczysty / transparent / прозрачный	
KM-BH75MM-30				brąz / brown / коричневый	







Rolka BRAZYLIA 35
Furniture caster BRAZYLIA 35
Колёсики BRAZYLIA 35

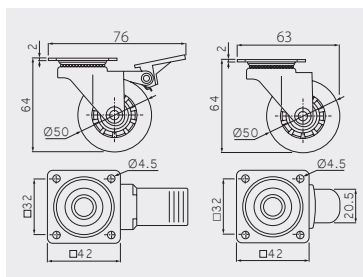

					
KM-RD-35-SF	bez hamulca without break без стопора	35	30	przeźroczysty / transparent / прозрачный	PC, PU
KM-RD-35-SF-20				czarny / black / чёрный	
KM-RD-35-CF	z hamulcem with break со стопором			przeźroczysty / transparent / прозрачный	
KM-RD-35-CF-20				czarny / black / чёрный	







Rolka BRAZYLIA 50
 Furniture caster BRAZYLIA 50
 Колёсики BRAZYLIA 50

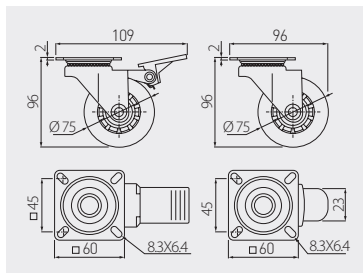

		 mm	 kg		
KM-RD-50-SF	bez hamulca without break	50	40	przeźroczysty / transparent / прозрачный	PC, PU
KM-RD-50-SF-20	bez stopora			czarny / black / чёрный	
KM-RD-50-CF	z hamulcem with break			przeźroczysty / transparent / прозрачный	
KM-RD-50-CF-20	so stoporem			czarny / black / чёрный	

Rolka BRAZYLIA 75
 Furniture caster BRAZYLIA 75
 Колёсики BRAZYLIA 75



		 mm	 kg		
KM-RD-75-SF	bez hamulca without break	75	64	przeźroczysty / transparent / прозрачный	PC, PU
KM-RD-75-SF-20	bez stopora			czarny / black / чёрный	
KM-RD-75-CF	z hamulcem with break			przeźroczysty / transparent / прозрачный	
KM-RD-75-CF-20	so stoporem			czarny / black / чёрный	

Zamek K-138
 Lock K-138
 Замок K-138

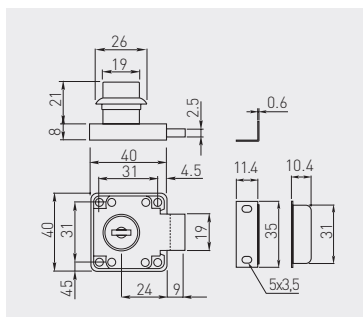

ZZ-KM-138-01



chrom / chrome / хром



ZnAl, stal / ZnAl, steel / ZnAl, сталь

Zamek Z-138 z kluczem łamanym
 Lock Z-138 with folding key
 Замок Z-138 со складным ключом

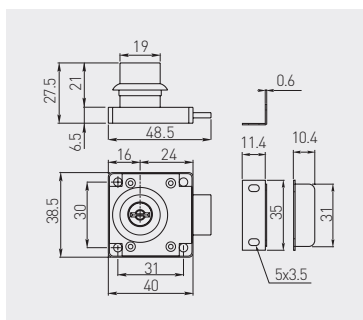

ZZ-ZN-138-01



chrom / chrome / хром



ZnAl, stal / ZnAl, steel / ZnAl, сталь

Zamek C-138 z kluczem cyfrowym
 Lock C-138 with key
 Замок C-138 с цифровым ключом

Kompatybilny z kluczem MASTER
 Compatible with MASTER key
 Подходит для ключа MASTER

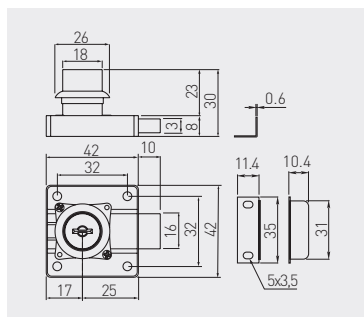

ZZ-CF-138-01



chrom / chrome / хром



ZnAl, stal / ZnAl, steel / ZnAl, сталь

Klucz MASTER do zamka C-138
 MASTER key for C-138 lock
 Ключ MASTER к замку C-138



ZZ-KLMASTER



chrom / chrome / хром



ZnAl, stal / ZnAl, steel / ZnAl, сталь

Zamek Z-338 zatrzaskowy
 Square lock Z-338
 Замок Z-338 с защёлкой

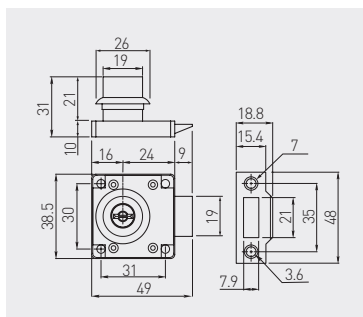

ZZ-ZN-338-01

chrom / chrome / хром

ZnAl, stal / ZnAl, steel / ZnAl, сталь

Zamek B-105 bolcowy
 Pin lock B-105
 Замок B-105 кнопочный

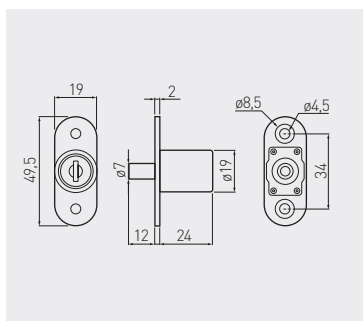





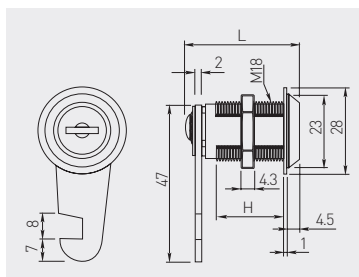

ZZ-B0-105-01

chrom / chrome / хром

ZnAl, stal / ZnAl, steel / ZnAl, сталь

Zamek Z-103 skrzynkowy
Box lock Z-103
Замок Z-103



		 L mm	 H mm		
ZZ-16-103-01		27	12	chrom / chrome / хром	ZnAl, stal / ZnAl, steel / ZnAl, сталь
ZZ-20-103-01		30	16,5		
ZZ-30-103-01		40	26,5		

Zamek S-407 do szyb
Glass door lock S-407
Замок S-407 для стеклянной распашной двери

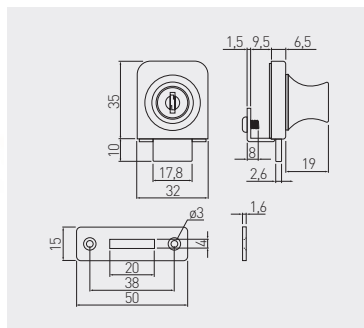

			
ZZ-SZ-407-01		chrom / chrome / хром	ZnAl, stal / ZnAl, steel / ZnAl, сталь

Zamek S-408 do szyb
Glass door lock S-408
Замок S-408 для стеклянных дверей

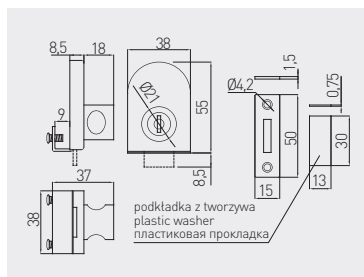

Zastosowanie do szkła 4 - 8 mm
For 4 - 8 mm glass
Толщина стекла 4-8 мм



ZZ-SZ-408-01

chrom / chrome / хром

ZnAl, stal / ZnAl, steel / ZnAl, сталь

Zamek S-409 do szyb
Glass door lock S-409
Замок S-409 для стеклянных дверей

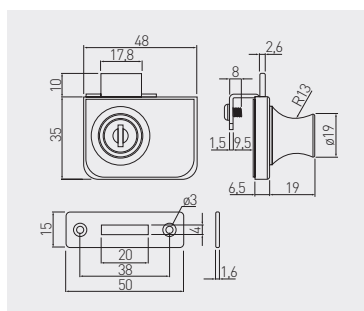

Zastosowanie do szkła 4 - 8 mm
For 4 - 8 mm glass
Толщина стекла 4-8 мм



ZZ-SZ-409-01

chrom / chrome / хром

ZnAl, stal / ZnAl, steel / ZnAl, сталь

Zamek M-201
Lock M-201
Замок M-201

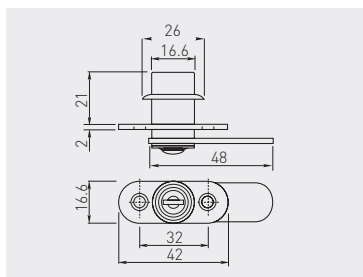

ZZ-M0-201-01



chrom / chrome / хром



ZnAl, stal / ZnAl, steel / ZnAl, сталь

Zamek Z-202 żaluzjowy
Double hook lock Z-202
Замок Z-202 жалюзийный

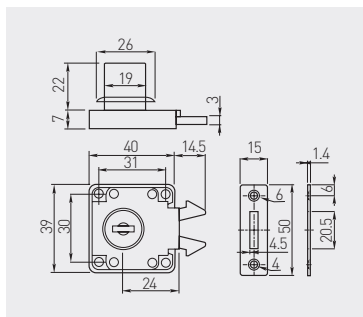

ZZ-Z0-202-01



chrom / chrome / хром



ZnAl, stal / ZnAl, steel / ZnAl, сталь

Zamek G-328 grzbietowy
Sliding glass door lock G-328
Замок G-328 внутренний

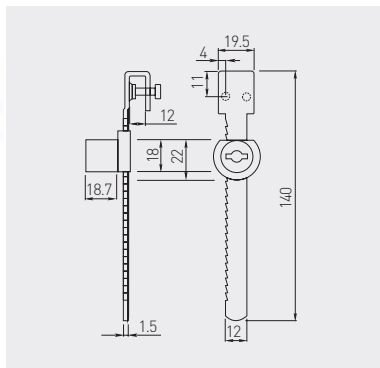

Zastosowanie do szkła 4 - 8 mm
For 4 - 8 mm glass
Толщина стекла 4 - 8 мм



ZZ-G0-328-01

chrom / chrome / хром

ZnAl, stal / ZnAl, steel / ZnAl, сталь

Zamek baskwilowy
Espagnolette lock
Замок шпингалетный

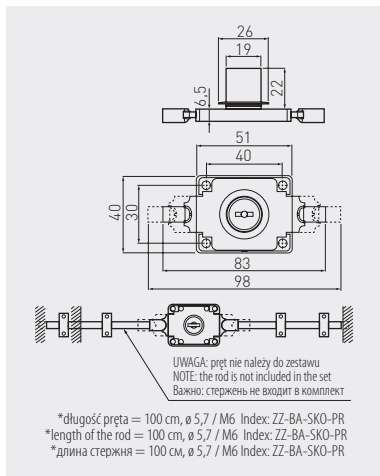

ZZ-BA-SK0-01

chrom / chrome / хром

ZnAl, stal / ZnAl, steel / ZnAl, сталь

Zamek C-288 centralny
Cabinet drawer lock C-288
Замок C-288 центральный боковой

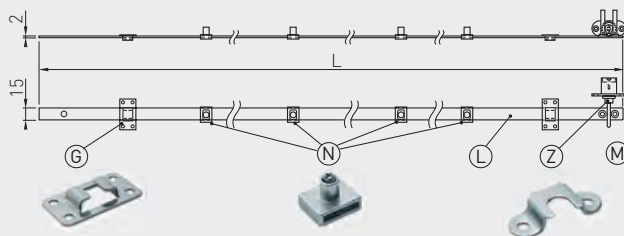

Skład zestawu / Set includes / Состав набора:

- ⓐ Mocowanie listwy / Slat fixing / Крепление планки
- ⓑ Blokady szuflady / Drawer locking mechanism / Блокада ящика
- ⓒ Listwa zamka / Lock slat / Планка замка
- ⓓ Zamek / Lock / Замок
- ⓔ Zaczepek / Hook / Зацепка

Model	C5	C6	C8	C1
L	500	600	800	1200
N	3	3	4	4
M	3	3	4	4
G	2	2	3	3

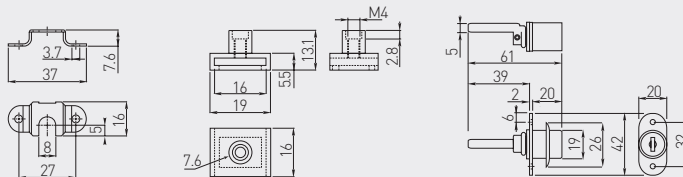

	 mm		
ZZ-C5-288-01	500	chrom / chrome / хром	ZnAl, stal / ZnAl, steel / ZnAl, сталь
ZZ-C6-288-01	600		
ZZ-C8-288-01	800		
ZZ-C1-288-01	1200		

**SYSTEMY PRZESUWNE
SLIDING DOOR SYSTEMS
РАЗДВИЖНЫЕ СИСТЕМЫ**

Dolny układ jezdny
Bottom-running systems
Нижняя ходовая система

394 – 420

Górny układ jezdny
Top-running systems
Верхняя ходовая система



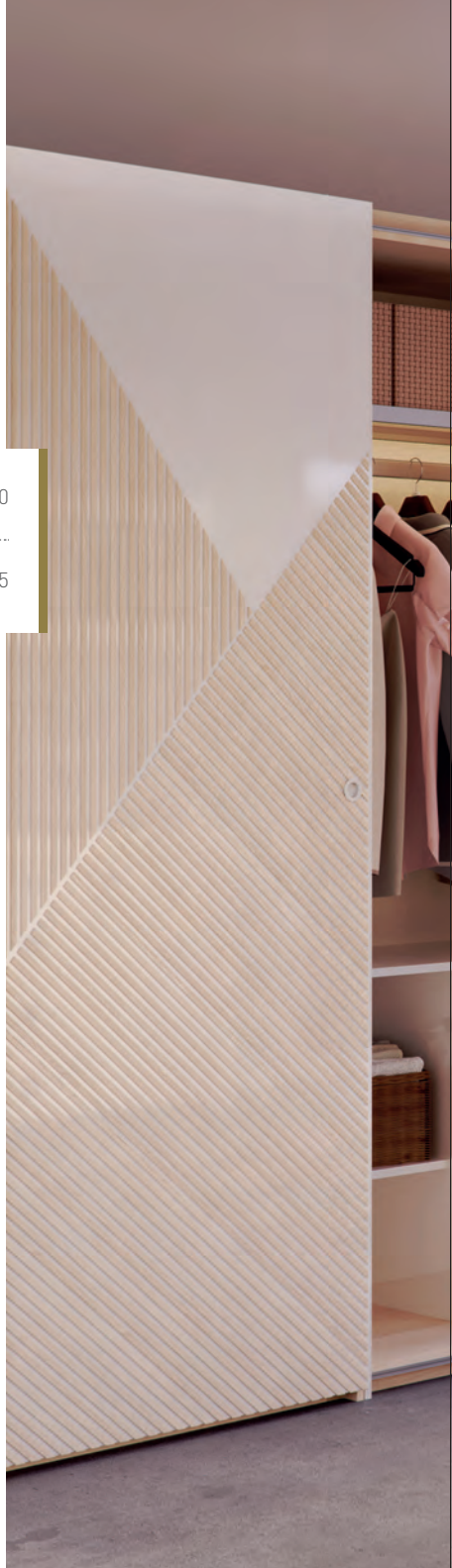

421 – 425



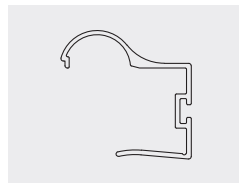

Rączka ERGO
Handle ERGO
Ручка ERGO



	 mm		
A-R18ERG-270-05	2700	aluminium / aluminium / алюминий	aluminium aluminium алюминий
A-R18ERG-270-90		szampan / champagne / шампань	



Rączka ERGO 16
Handle ERGO 16
Ручка ERGO 16

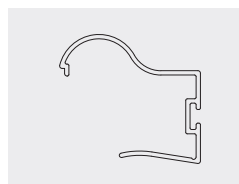

	 mm		
A-R16ERG-270-50	2700	aluminium / aluminium / алюминий	aluminium / aluminium / алюминий



Rączka NOVO 2
Handle NOVO 2
Ручка NOVO 2

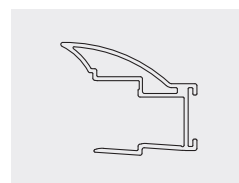



	 mm		
A-RNOV2-270-05	2700	aluminium / aluminium / алюминий	aluminium aluminium алюминий
A-RNOV2-270-10		biały / white / белый	
A-RNOV2-270-90		szampan / champagne / шампань	

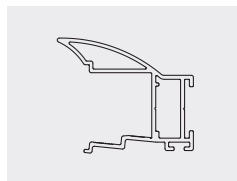

Rączka NOVO S
Handle NOVO S
Ручка NOVO S



	 L mm		
A-R18NOVS-270-05	2700	aluminium / aluminium / алюминий	aluminium aluminium алюминий
A-R18NOVS-270-10		biały / white / белый	
A-R18NOVS-270-20M		czarny / black / чёрный	
A-R18NOVS-270-90		szampan / champagne / шампань	



Rączka NOVO S 19/4 mm
Handle NOVO S 19/4 mm
Ручка NOVO S 19/4 mm



NEW

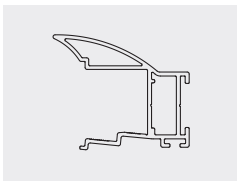





	 L mm		
A-R19NOVS-300-05	3000	aluminium / aluminium / алюминий	aluminium / aluminium / алюминий

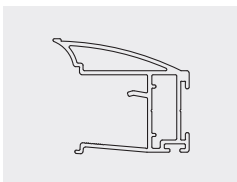

Rączka CARO
Handle CARO
Ручка CARO





	 L mm		
A-R18CARO-270-05	2700	aluminium / aluminium / алюминий	aluminium aluminium алюминий
A-R18CARO-270-90		szampan / champagne / шампань	

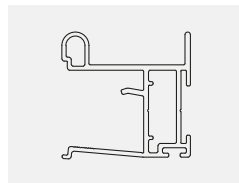

Rączka VISTA
Handle VISTA
Ручка VISTA





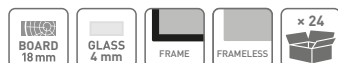

	 mm		
A-R18VIS-270-05	2700	aluminium / aluminium / алюминий	aluminium aluminium алюминий
A-R18VIS-270-90		szampan / champagne / шампань	

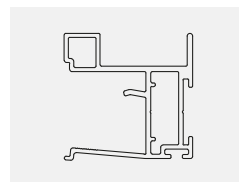

Rączka NERO
Handle NERO
Ручка NERO



	 mm		
A-R18NERO-270-05	2700	aluminium / aluminium / алюминий	aluminium aluminium алюминий
A-R18NERO-270-10		biały / white / белый	
A-R18NERO-270-20M		czarny / black / чёрный	
A-R18NERO-270-90		szampan / champagne / шампань	

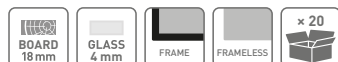

Rączka NERO 19/4 mm
Handle NERO 19/4 mm
Ручка NERO 19/4 mm



NEW

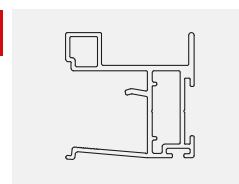



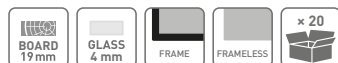

	 mm		
A-R19NERO-300-05	3000	aluminium / aluminium / алюминий	aluminium / aluminium / алюминий

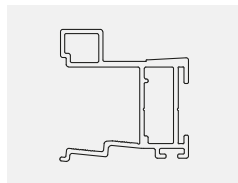

Rączka COTE
Handle COTE
Ручка COTE







	 mm		
A-R18COTE-270-05	2700	aluminium / aluminium / алюминий	aluminium
A-R18COTE-270-90		szampan / champagne / шампань	aluminium алюминий

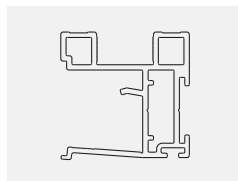

Rączka LOCA
Handle LOCA
Ручка LOCA





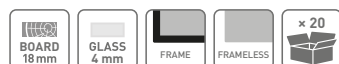

	 mm		
A-R18LOCA-305-05	3050	aluminium / aluminium / алюминий	aluminium
A-R18LOCA-305-90		szampan / champagne / шампань	aluminium алюминий

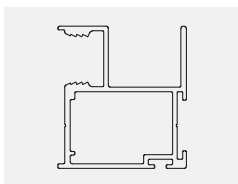

Rączka FLAT LINE
Handle FLAT LINE
Ручка FLAT LINE





	 mm		
A-R10FL-270-05	2700	aluminium / aluminium / алюминий	aluminium aluminium алюминий
A-R10FL-270-10		biały / white / белый	
A-R10FL-270-90		szampan / champagne / шампань	

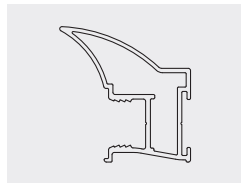

Rączka NOVO 10
Handle NOVO 10
Ручка NOVO 10



	 mm		
A-R10NOV-270-05	2700	aluminium / aluminium / алюминий	aluminium aluminium алюминий
A-R10NOV-270-10		biały / white / белый	
A-R10NOV-270-90		szampan / champagne / шампань	



Rączka FORM
Handle FORM
Ручка FORM

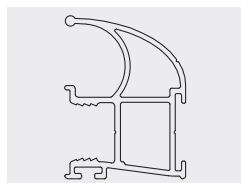





	 mm		
A-R10FORM-270-05	2700	aluminium / aluminium / алюминий	aluminium aluminium алюминий
A-R10FORM-270-90		biały / white / белый	

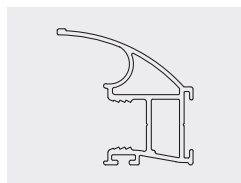

Rączka TRAF0
Handle TRAF0
Ручка TRAF0



	 mm		
A-R10TRAF0-270-05	2700	aluminium / aluminium / алюминий	aluminium aluminium алюминий
A-R10TRAF0-270-90		szampan / champagne / шампань	



Rączka TORO
Handle TORO
Ручка TORO

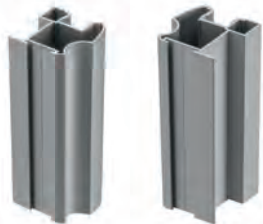

NEW

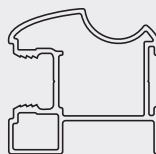

A-R10TORO-270-05	2700	aluminium / aluminium / алюминий	aluminium aluminium алюминий
A-R10TORO-270-90		szampan / champagne / шампань	



Rączka FALDA
Handle FALDA
Ручка FALDA

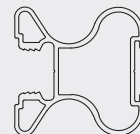

A-R10FALDA-270-05	2700	aluminium / aluminium / алюминий	aluminium aluminium алюминий
A-R10FALDA-270-90		szampan / champagne / шампань	



Rączka ARCO
Handle ARCO
Ручка ARCO

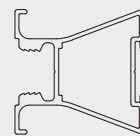

A-R10ARCO-270-05	2700	aluminium / aluminium / алюминий	aluminium aluminium алюминий
A-R10ARCO-270-90		szampan / champagne / шампань	



Rączka GEO
Handle GEO
Ручка GEO



NEW

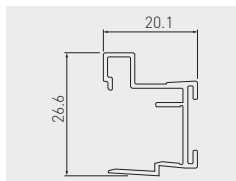

A-R18GEO-270-05

2700

aluminium / aluminium / алюминий

aluminium / aluminium / алюминий



Tor górny
Top track
Верхняя направляющая

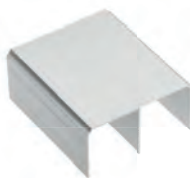

A-TG-170-05	1700	aluminium / aluminium / алюминий	aluminium aluminium алюминий
A-TG-170-90		szampan / champagne / шампань	
A-TG-235-05	2350	aluminium / aluminium / алюминий	
A-TG-235-90		szampan / champagne / шампань	
A-TG-300-05	3000	aluminium / aluminium / алюминий	
A-TG-300-10		biały / white / белый	
A-TG-300-20M		czarny / black / чёрный	
A-TG-300-90		szampan / champagne / шампань	
A-TG-405-05	4050	aluminium / aluminium / алюминий	
A-TG-405-10		biały / white / белый	
A-TG-405-90		szampan / champagne / шампань	
A-TG-600-05	6000	aluminium / aluminium / алюминий	
A-TG-600-90		szampan / champagne / шампань	



Torny dolny EVO
Bottom track EVO
Нижняя направляющая EVO



	 L mm		
A-TDEVO-170-05	1700	aluminium / aluminium / алюминий	aluminium aluminium алюминий
A-TDEVO-170-90		szampan / champagne / шампань	
A-TDEVO-235-05	2350	aluminium / aluminium / алюминий	
A-TDEVO-235-90		szampan / champagne / шампань	
A-TDEVO-300-05	3000	aluminium / aluminium / алюминий	
A-TDEVO-300-10		biały / white / белый	
A-TDEVO-300-20M		czarny / black / чёрный	
A-TDEVO-300-90	4050	szampan / champagne / шампань	
A-TDEVO-405-05		aluminium / aluminium / алюминий	
A-TDEVO-405-10		biały / white / белый	
A-TDEVO-405-90	6000	szampan / champagne / шампань	
A-TDEVO-600-05		aluminium / aluminium / алюминий	
A-TDEVO-600-90		szampan / champagne / шампань	



Maskownica EVO
Masking cover EVO
Декоративная накладка



	 L mm		
A-MEVO-170-05	1700	aluminium / aluminium / алюминий	aluminium aluminium алюминий
A-MEVO-170-90		szampan / champagne / шампань	
A-MEVO-235-05	2350	aluminium / aluminium / алюминий	
A-MEVO-235-90		szampan / champagne / шампань	
A-MEVO-300-05	3000	aluminium / aluminium / алюминий	
A-MEVO-300-10A		biały / white / белый	
A-MEVO-300-20M		czarny / black / чёрный	
A-MEVO-300-90	4050	szampan / champagne / шампань	
A-MEVO-405-05		aluminium / aluminium / алюминий	
A-MEVO-405-10		biały / white / белый	
A-MEVO-405-90	6000	szampan / champagne / шампань	
A-MEVO-600-05		aluminium / aluminium / алюминий	



Torny dolny EVO 2
Bottom track EVO 2
Нижняя направляющая EVO 2

NEW







	 L mm		
A-TDEVO2-170-05	1700	aluminium / aluminium / алюминий	aluminium aluminium алюминий
A-TDEVO2-170-90		szampan / champagne / шампань	
A-TDEVO2-235-05	2350	aluminium / aluminium / алюминий	
A-TDEVO2-235-90		szampan / champagne / шампань	
A-TDEVO2-300-05	3000	aluminium / aluminium / алюминий	
A-TDEVO2-300-90		szampan / champagne / шампань	
A-TDEVO2-405-05	4050	aluminium / aluminium / алюминий	
A-TDEVO2-405-90		szampan / champagne / шампань	
A-TDEVO2-600-05	6000	aluminium / aluminium / алюминий	
A-TDEVO2-600-90		szampan / champagne / шампань	



Tor dolny PRO
Bottom track PRO
Нижняя направляющая PRO







	 L mm		
A-TDPRO-170-05	1700	aluminium / aluminium / алюминий	aluminium aluminium алюминий
A-TDPRO-170-90		szampan / champagne / шампань	
A-TDPRO-235-05	2350	aluminium / aluminium / алюминий	
A-TDPRO-235-90		szampan / champagne / шампань	
A-TDPRO-300-05	3000	aluminium / aluminium / алюминий	
A-TDPRO-300-10		biały / white / белый	
A-TDPRO-300-90	3000	szampan / champagne / шампань	
A-TDPRO-405-05		4050	
A-TDPRO-405-90	szampan / champagne / шампань		
A-TDPRO-600-05	6000	aluminium / aluminium / алюминий	
A-TDPRO-600-90		szampan / champagne / шампань	



Maskownica PRO
Masking cover PRO
Декоративная накладка PRO



	 L mm		
A-MPRO-170-05	1700	aluminium / aluminium / алюминий	aluminium aluminium алюминий
A-MPRO-170-90		szampan / champagne / шампань	
A-MPRO-235-05	2350	aluminium / aluminium / алюминий	
A-MPRO-235-90		szampan / champagne / шампань	
A-MPRO-300-05	3000	aluminium / aluminium / алюминий	
A-MPRO-300-10		biały / white / белый	
A-MPRO-300-90		szampan / champagne / шампань	
A-MPRO-405-05	4050	aluminium / aluminium / алюминий	
A-MPRO-405-90		szampan / champagne / шампань	



Listwa górna 18/4 mm
Top strip 18/4 mm
Профиль горизонтальный верхний 18/4 мм

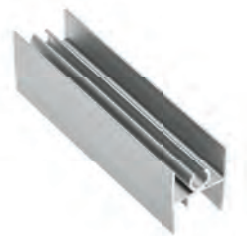

	 L mm		
A-LG18-170-05	1700	aluminium / aluminium / алюминий	aluminium aluminium алюминий
A-LG18-170-90		szampan / champagne / шампань	
A-LG18-235-05	2350	aluminium / aluminium / алюминий	
A-LG18-235-90		szampan / champagne / шампань	
A-LG18-300-05	3000	aluminium / aluminium / алюминий	
A-LG18-300-10		biały / white / белый	
A-LG18-300-20M		czarny / black / чёрный	
A-LG18-300-90		szampan / champagne / шампань	
A-LG18-405-05	4050	aluminium / aluminium / алюминий	
A-LG18-405-90		szampan / champagne / шампань	
A-LG18-600-90	6000	szampan / champagne / шампань	



Listwa górna 19/4 mm
 Top strip 19/4 mm
 Профиль горизонтальный верхний 19/4 мм

NEW



			
A-LG19-300-05	3000	aluminium aluminium алюминий	aluminium aluminium алюминий



Listwa dolna 18/4 mm
 Bottom strip 18/4 mm
 Профиль горизонтальный нижний 18/4 мм



			
A-LD18-170-05	1700	aluminium / aluminium / алюминий	aluminium aluminium алюминий
A-LD18-170-90		szampan / champagne / шампань	
A-LD18-235-05	2350	aluminium / aluminium / алюминий	
A-LD18-235-90		szampan / champagne / шампань	
A-LD18-300-05	3000	aluminium / aluminium / алюминий	
A-LD18-300-10		biały / white / белый	
A-LD18-300-20M		czarny / black / чёрный	
A-LD18-300-90		szampan / champagne / шампань	
A-LD18-405-05	4050	aluminium / aluminium / алюминий	
A-LD18-405-90		szampan / champagne / шампань	
A-LD18-600-90	6000	szampan / champagne / шампань	



Listwa dolna 19/4 mm
Bottom strip 19/4 mm
Профиль горизонтальный нижний 19/4 мм

NEW







	 mm		
A-LD19-300-05	3000	aluminium aluminium алюминий	aluminium aluminium алюминий



Listwa górna 10/4 mm
Top strip 10/4 mm
Профиль горизонтальный верхний 10/4 мм





	 mm		
A-LG10-170-05	1700	aluminium / aluminium / алюминий	aluminium aluminium алюминий
A-LG10-235-05	2350	aluminium / aluminium / алюминий	
A-LG10-235-90		szampan / champagne / шампань	
A-LG10-300-05	3000	aluminium / aluminium / алюминий	
A-LG10-300-10		biały / white / белый	
A-LG10-300-90		szampan / champagne / шампань	
A-LG10-405-05	4050	aluminium / aluminium / алюминий	
A-LG10-405-90		szampan / champagne / шампань	
A-LG10-600-05	6000	aluminium / aluminium / алюминий	
A-LG10-600-90		szampan / champagne / шампань	



Listwa dolna 10/4 mm
Bottom strip 10/4 mm
Профиль горизонтальный нижний 10/4 мм



	 L mm		
A-LD10-170-05	1700	aluminium / aluminium / алюминий	aluminium aluminium алюминий
A-LD10-235-05	2350	aluminium / aluminium / алюминий	
A-LD10-235-90		szampan / champagne / шампань	
A-LD10-300-05	3000	aluminium / aluminium / алюминий	
A-LD10-300-10		biały / white / белый	
A-LD10-300-90		szampan / champagne / шампань	
A-LD10-405-05	4050	aluminium / aluminium / алюминий	
A-LD10-405-90		szampan / champagne / шампань	
A-LD10-600-05	6000	aluminium / aluminium / алюминий	
A-LD10-600-90		szampan / champagne / шампань	



Listwa górna FL 10/4 mm
Top strip FL 10/4 mm
Профиль горизонтальный верхний FL 10/4 мм



	 L mm		
A-LG10FL-235-05	2350	aluminium / aluminium / алюминий	aluminium aluminium алюминий
A-LG10FL-235-90		szampan / champagne / шампань	
A-LG10FL-300-05	3000	aluminium / aluminium / алюминий	
A-LG10FL-300-10		biały / white / белый	
A-LG10FL-300-90		szampan / champagne / шампань	







Listwa dolna FL 10 / 4 mm

Bottom strip FL 10/4 mm

Профиль горизонтальный нижний FL 10/4 мм



	 L mm		
A-LD10FL-235-05	2350	aluminium / aluminium / алюминий	aluminium aluminium алюминий
A-LD10FL-235-90		szampan / champagne / шампань	
A-LD10FL-300-05	3000	aluminium / aluminium / алюминий	
A-LD10FL-300-10		biały / white / белый	
A-LD10FL-300-90		szampan / champagne / шампань	







Kątownik

Angle bar

Профиль угловой







	 L mm		
A-K18-300-05	3000	aluminium / aluminium / алюминий	aluminium aluminium алюминий
A-K18-300-10		biały / white / белый	
A-K18-300-20M		czarny / black / чёрный	
A-K18-300-90		szampan / champagne / шампань	



Profil C18
Profile C18
Профиль C18







	 L mm		
A-C18-300-05	3000	aluminium / aluminium / алюминий	aluminium aluminium алюминий
A-C18-300-10		biały / white / белый	
A-C18-300-20M		czarny / black / чёрный	
A-C18-300-90		szampan / champagne / шампань	



Profil T18
Profile T18
Профиль T18





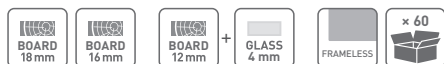

	 L mm		
A-T18-300-05	3000	aluminium / aluminium / алюминий	aluminium aluminium алюминий
A-T18-300-10		biały / white / белый	
A-T18-300-90		szampan / champagne / шампань	



Profil H16
Profile H16
Профиль H16







	 L mm		
A-H16-300-05	3000	aluminium / aluminium / алюминий	aluminium aluminium алюминий
A-H16-300-90		szampan / champagne / шампань	

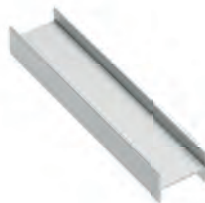

Profil H18
Profile H18
Профиль H18







	 L mm		
A-H18-300-05	3000	aluminium / aluminium / алюминий	aluminium aluminium алюминий
A-H18-300-10		biały / white / белый	
A-H18-300-20M		czarny / black / чёрный	
A-H18-300-90		szampan / champagne / шампань	



Profil HR18
Profile HR18
Профиль HR18



	 L mm		
A-HR18-300-05	3000	aluminium / aluminium / алюминий	aluminium aluminium алюминий
A-HR18-300-10		biały / white / белый	
A-HR18-300-20M		czarny / black / чёрный	
A-HR18-300-90		szampan / champagne / шампань	



Profil HR19
Profile HR19
Профиль HR19

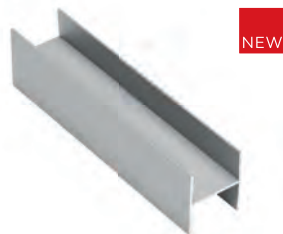





	 L mm		
A-HR19-300-05	3000	aluminium / aluminium / алюминий	aluminium / aluminium / алюминий

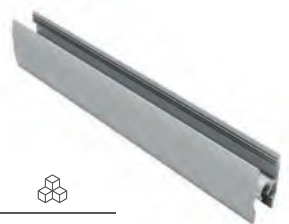

Profil HRS10
Profile HRS10
Профиль HRS10







	 L mm		
A-HRS10-170-05	1700	aluminium / aluminium / алюминий	aluminium aluminium алюминий
A-HRS10-300-05	3000		
A-HRS10-300-90		szampan / champagne / шампань	
A-HRS10-405-05	4050	aluminium / aluminium / алюминий	
A-HRS10-600-05	6000		



Profil HR10 FL
Profile HR10 FL
Профиль HR10 FL





	 L mm		
A-HR10FL-300-05	3000	aluminium / aluminium / алюминий	aluminium aluminium алюминий
A-HR10FL-300-10		biały / white / белый	
A-HR10FL-300-90		szampan / champagne / шампань	





Prowadnik górny PG-18
Top roller PG-18
Верхний ролик PG-18



	 kg	
A-PG-18	50	stal, tworzywo steel, plastic сталь, пластмасса





Prowadnik górny PGR-18
Top roller PGR-18
Верхний ролик PGR-18

		
A-PGR-18	50	stal, tworzywo steel, plastic сталь, пластмасса





Prowadnik górny PGR-10
Top roller PGR-10
Верхний ролик PGR-10

		
A-PGR-10	50	stal, tworzywo steel, plastic сталь, пластмасса





Prowadnik górny PGR-10 symetryczny
Top roller PGR-10 symmetrical
Верхний ролик PGR-10 симметричный

		
A-PGR-10S	50	stal, tworzywo steel, plastic сталь, пластмасса



Płytk dystansowa
Spacer plate
Распорная пластина





		
A-DPG-16	50	stal steel сталь



Wózek dolny EVO
Bottom roller EVO
Нижний ролик EVO





		
A-WD-EVO	50	stal, tworzywo steel, plastic сталь, пластмасса



Wózek dolny PRO
Bottom roller PRO
Нижний ролик PRO





		
A-WD-PRO	50	stal, tworzywo steel, plastic сталь, пластмасса



Wózek dolny EVO rama
Bottom roller EVO frame
Нижний ролик EVO для рамной системы





	 kg	
A-WDR-EVO	50	stal, tworzywo steel, plastic сталь, пластмасса



Wózek dolny PRO rama
Bottom roller PRO frame
Нижний ролик PRO для рамной системы





	 kg	
A-WDR-PRO	50	stal, tworzywo steel, plastic сталь, пластмасса



Pozycjoner górny
Top positioner
Верхний стопор





	 kg	
A-PTG	50	tworzywo plastic пластмасса



Pozycjoner dolny PRO
Bottom positioner PRO
Нижний стопор PRO



		
A-PTD	50	stal steel сталь



Szczotka odbojowa 4,8x4
Buffer strip 4,8x4
Буферная щётка 4,8x4





		
A-SO-48X4	szary gray серый	tworzywo plastic пластмасса



Szczotka odbojowa szeroka 14,5x4
Buffer strip wide 14,5x4
Буферная щётка широкая 4,8x4



		
A-SO-145X4	szary / gray / серый	tworzywo plastic пластмасса
A-SO-145X4-10	biały / white / белый	
A-SO-145X4-20	czarny / black / чёрный	



Szczotka przeciwkurzowa bez kleju 4,8x7
 Anti-dust strip without glue 4,8x7
 Противопылевая щётка без клея 4,8x7



		
A-SP-48X7	szary gray серый	tworzywo plastic пластмасса



Szczotka przeciwkurzowa z klejem 7x12
 Anti-dust strip with glue 7x12
 Противопылевая щётка на клеевой основе 7x12



		
A-SP-7X12	szary gray серый	tworzywo plastic пластмасса



Szczotka przeciwkurzowa bez kleju 4,8x12
 Anti-dust strip without glue 4,8x12
 Противопылевая щётка 4,8x12 (вставная)



		
A-SP-48X12	szary gray серый	tworzywo plastic пластмасса



Klin do rączek
Wedge for handle
Клин для профиль-ручки

		
A-KR-4	biały white белый	tworzywo plastic пластмасса





Klin do listew poziomych
Wedge for horizontal strips
Клин для горизонтальных профилей

		
A-KLP-4	biały white белый	tworzywo plastic пластмасса



Klips do mocowania toru dolnego EVO 2
Mounting clip for bottom track EVO 2
Клипса для крепления нижней направляющей EVO 2

NEW

		
A-ZAT-TDEV02	mleczny milk молочный	tworzywo plastic пластмасса





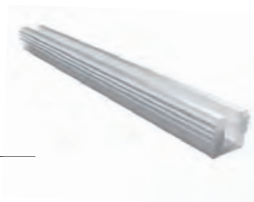

Uszczelka typ CH twarda
Seal type CH, hard
Уплотнитель типа CH, твердый

			
A-USZCZ-CH4	100	przeźroczysty transparent прозрачный	tworzywo plastic пластмасса



Uszczelka typ U, średnio twarda
Gasket U, medium hard
Уплотнитель тип U, средней твердости







	 L m		
A-USZCZ-U4	100	przeźroczysty transparent прозрачный	tworzywo plastic пластмасса



Uszczelka typ CH miękka
Seal type CH, soft
Уплотнитель типа CH, мягкий



	 L m		
A-USZCZ-CHM4	120	przeźroczysty transparent прозрачный	tworzywo plastic пластмасса



Uszczelka do toru dolnego EVO 2
Gasket for EVO 2 track
Уплотнитель для нижней направляющей EVO 2





NEW

	 L m		
A-USZCZ-TDEV02	200	mleczny milk молочный	PVC



Błachowkręt 6,3x40
Steel metal screw 6,3x40
Сборочный винт 6,3x40

	
A-B63-40	stal steel сталь





Błachowkręt 6,3x32
Steel metal screw 6,3x32
Сборочный винт 6,3x40

	
A-B63-32	stal steel сталь





Spowalnicz SIMON skrajny
Internal soft closing damper SIMON
Боковой доводчик SIMON

		
A-SOFT-30	30	stal, tworzywo steel, plastic сталь, пластмасса
A-SOFT-50	50	



Spowalnicz SIMON środkowy
Internal soft closing damper SIMON
Центральный доводчик SIMON





		
A-MSOFT-RAMA	50	stal, tworzywo steel, plastic сталь, пластмасса



Zestaw adaptera do spowalnicza środkowego
Adapter set for soft closing damper
Адаптер для доводчика





		
A-MSOFT-ADAPT	50	stal steel сталь







Ręczny przyrząd wiertarski z dociskiem
Hand drilling tool with locking screws
Ручной сверлильный кондуктор с зажимом



	
A-PW-RC-DOC	stal steel сталь



MITO
MITO
MITO

	A-TMITO-200-05	200	50	aluminium aluminium алюминий	aluminium aluminium алюминий	56	
	A-TMITO-250-05	250		surowe aluminium raw aluminum сырой алюминий			
	A-TMITO-250-00						
	A-TMITO-300-05						300
	Pozycjoner Positioner Стоп	A-POZ-MITO	-	szary gray серый	tworzywo plastic пластмасса	1000	
	Wózek górny Top guide Верхний проводник	A-SG-MITO	-	ocynk zink оцинковка	stal, tworzywo steel, plastic сталь, пластмасса	400	
	Wózek dolny z łożyskiem kulkowym Bottom roller with ball bearing Нижний ролик с шариковым подшипником	A-RD-MITO	-				

Zestaw MITO PLUS
MITO PLUS set
MITO PLUS комплект

2 wózki górne ze sprężyną, 2 wózki dolne z łożyskiem kulkowym, 1 pozycjoner, komplet wkrętów

2 top rollers with spring, 2 bottom ball bearing rollers, 1 positioner, set of screws

2 верхних проводника с пружиной, 2 нижних ролика с шариковым подшипником, 1 стопор, комплект шурупов



A-MITO-PLUS	50	ocynk / zink / оцинковка	stal / steel / сталь
-------------	----	--------------------------	----------------------



Zestaw OVERLINE

OVERLINE set

OVERLINE комплект



2 szt. wózków zewnętrznych, 2 szt. wózków wewnętrznych, 2 szt. pozycjonerów, 2 szt. prowadników dolnych ślizgowych drzwi zewnętrznych
 2 external rollers, 2 internal rollers, 2 positioners, 2 bottom slides for external door, 2 bottom slides of internal door

Внешние ролики-2шт., внутренние ролики-2шт., нижние ходовые элементы внешней двери-2 шт., нижние ходовые элементы внутренней двери-2 шт., позиционер-2 шт.

A-SN-FSET	50	ocynk / zink / оцинковка	stal, tworzywo / steel, plastic / сталь, пластмасса	10	

	A-SN-R19RIV-270-05	2700	-			24
	A-SN-K19-270-05		-	aluminium aluminium алюминий	aluminium aluminium алюминий	48
	A-C18-300-05	3000	-			60
	A-SN-TG-405-00	4050	50	surowe aluminium raw aluminium сырой алюминий	stal steel сталь	80
	A-SN-TDS-405-00				aluminium aluminium алюминий	40
	A-SN-SOFT-25	-	25	szary gray серый	tworzywo plastic пластмасса	100
	A-SN-SOFT-40	-	40			
	A-SN-ADSET	-	-	-	stal, tworzywo steel, plastic сталь, пластмасса	100

Zestaw OVERLINE PLUS

OVERLINE PLUS set

OVERLINE PLUS комплектация



2 szt. wózków zewnętrznych, 2 szt. wózków wewnętrznych, 2 szt. prowadników dolnych tocznych drzwi zewnętrznych, 2 szt. prowadników dolnych tocznych drzwi wewnętrznych, 1 zestaw wkrętów

2 external rollers, 2 internal rollers, 2 bottom slides for external door, 2 bottom slides for internal door, screws

Составляющие: внешние ролики-2шт., внутренние ролики-2шт., нижние ходовые элементы внешней двери-2 шт., нижние ходовые элементы внутренней двери-2 шт., 1 клп. шурупов

						
A-SN-HSET1	50	ocynk / zink / оцинковка	stal, tworzywo / steel, plastic / сталь, пластмасса	1		
						
 Rączka RIVA Handle RIVA Ручка RIVA	A-SN-R19RIV-270-05	2700	-	aluminium aluminium алюминий	stal steel сталь	24
 Profil C19 Handle C19 Ручка C19	A-SN-K19-270-05	-	-	aluminium aluminium алюминий	aluminium aluminium алюминий	48
 Profil C18 Handle C18 Ручка C18	A-C18-300-05	3000	-	-	-	60
 Tor górny Top track Верхняя направляющая	A-SN-TG-405-00	4050	-	surowe aluminium raw aluminium сырой алюминий	stal steel сталь	80
 Tor dolny Bottom track Нижняя направляющая	A-SN-TDT-405-00	-	-	aluminium aluminium алюминий	aluminium aluminium алюминий	20
 Spowalniacz Soft closing damper доводчик	A-SN-SOFT-25	-	25	-	-	100
	A-SN-SOFT-40	-	40	-	tworzywo plastic пластмасса	20
 Pozycjoner Positioner Станоп	A-SN-POZ	-	-	czarny black черный	-	20
 Zestaw do spowalniacza Soft closing damper set доводчик комплектация 1szt. aktywator drzwi zew. i 1 szt. wew., 4 szt. adapterów, 1 zestaw wkrętów 1pc. activator outer door and 1 pc. inner door, 4 pcs. adapter, 1 screw set активатор веш. двери-1 шт., активатор внутр. двери-1 шт., адаптер-4 шт., 1клп. шурупов	A-SN-ADSET	-	-	-	stal, tworzywo steel, plastic сталь, пластмасса	100

Prostownica Warped door straightener Стяжка-выпрямитель



2 szt. listwy ściągającej, 2 szt. płytki naciągającej, 4 szt. płytki dociskowej, zaślepka, tuleja pozycjonująca, klucz do regulacji
Tightening strip 2 pcs, tensioning plate 2 pcs, pressure plate 4 pcs, cover cap, positioning sleeve, adjustment spanner
Планка с резьбой 2 шт., натяжная пластина 2 шт., прижимная пластина 4 шт., заглушка, зажимная гильза, ключ для регулировки



A-SN-SDP-TU

50

ocynk / zink / оцинковка

stal, tworzywo / steel, plastic / сталь, пластмасса

BOARD
16-22mm

x 10



Zestaw QUANTUM
 QUANTUM set
 Комплект QUANTUM



2 szt. wózków, 2 szt. stoperów, 2 szt. przewodników, komplet wkrętów

Rollers 2 pcs, stoppers 2 pcs, guide 2pcs, screw set

Ролики - 2 шт., стопор - 2 шт., проводник - 2 шт., комплект шурупов

A-BUDP-SET	50	aluminium / aluminium / алюминий	stal, tworzywo / steel, plastic / сталь, пластмасса	24

<p>Tor górny Top track Верхняя направляющая</p>	A-TG-BUD-200-00	2000	50	surowe aluminium raw aluminium сырой алюминий	aluminium aluminium алюминий	15
	A-TG-BUD-300-00	3000		aluminium aluminium алюминий	aluminium aluminium алюминий	
<p>Uchwyt boczny Side holder Боковое крепление</p>	A-BUD-UB	-		ocynk zink оцинковка	stal steel сталь	200
<p>Uchwyt górny Top holder Верхнее крепление</p>	A-BUD-UG	-		aluminium aluminium алюминий	aluminium aluminium алюминий	
<p>Uchwyt maskownicy toru górnego Top track masking cover holder Держатель декоративной панели</p>	A-BUD-UM	60		szary gray серый	stal, tworzywo steel, plastic сталь, пластмасса	100
<p>Uchwyt do ramy (4 szt) Frame holder (4 pcs) Крепление плиты</p>	A-BUD-UR	-		ocynk zink оцинковка	stal steel сталь	
<p>Uchwyt do płyty Board holder Держатель для плиты</p>	A-BUD-UP	-				



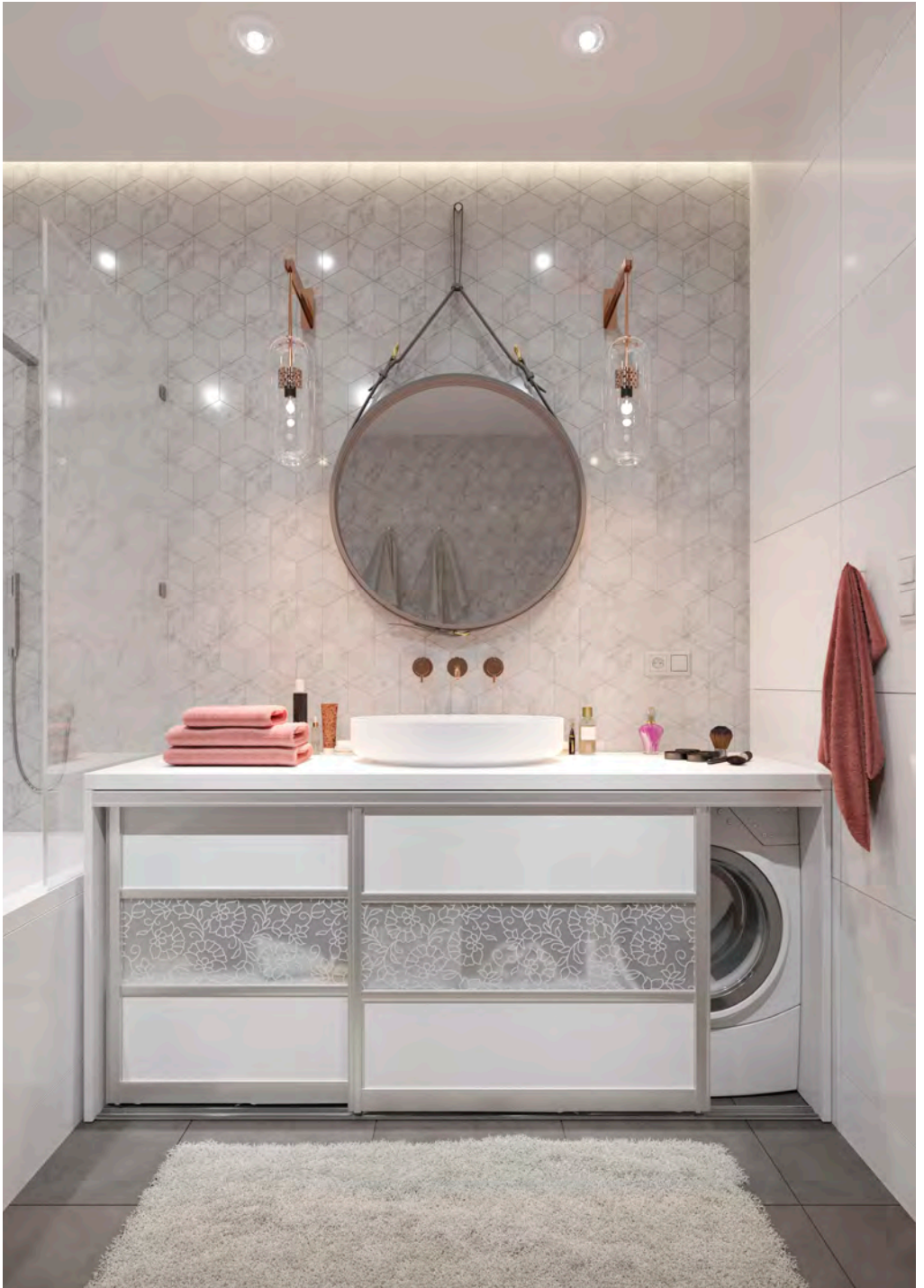

OŚWIETLENIE MEBLOWE FURNITURE LIGHTING МЕБЕЛЬНОЕ ОСВЕЩЕНИЕ

Taśmy LED LED strips Светодиодные ленты	428 – 429
Profile LED LED profiles Профили LED	430 – 448
Oprawy LED LED fittings Светодиодные светильники	449 – 469
Oprawy halogenowe Halogen fittings Галогенные светильники	470 – 471
Akcesoria Accessories Аксессуары	472 – 490
Przedłużacze biurkowe Desk power sockets Выдвижные розетки	491 – 497





ТаЅма LED FLASH
LED strip FLASH
Светоодиодная лента FLASH



	LD-3528-300-20-ZB	12 VDC 4,8 W/m	300 lm/m	● 6500 K	20	120°	5	8	60/m	5
	LD-3528-300-20-NE			● 5000 K						
	LD-3528-300-20-CB			● 3200 K						
	LD-3528-300-20-NI		-	niebieski blue синий						
	LD-3528-300-65-ZB	12 VDC 4,8 W/m	280 lm/m	● 6500 K	65					
	LD-3528-300-65-CB			● 3200 K						
	LD-3528-600-20-ZB	12 VDC 9,6 W/m	550 lm/m	● 6500 K	20	120°	5	8		
	LD-3528-600-20-CB			● 3200 K						
	LD-3528-600-65-ZB	12 VDC 9,6 W/m	520 lm/m	● 6500 K	65	120°	5	8	120/m	2,5
	LD-3528-600-65-CB			● 3200 K						
	LD-2835-300-20-ZB	12 VDC 6 W/m	750 lm/m	● 6500 K	20	120°	5	8	60/m	5
	LD-2835-300-20-NE			● 5000 K						
	LD-2835-300-20-CB			● 3200 K						
	LD-2835-300-65-ZB	12 VDC 6 W/m	700 lm/m	● 6500 K	65					
	LD-2835-300-65-CB			● 3200 K						
	LD-5050-300-20-ZB	12 VDC 14,4 W/m	900 lm/m	● 6500 K	20	120°	5	10	60/m	5
	LD-5050-300-20-CB			● 3200 K						
	LD-5050-300-65-ZB	12 VDC 14,4 W/m	850 lm/m	● 6500 K	65					
	LD-5050-300-65-CB			● 3200 K						
	LD-5630-300-20-ZB	12 VDC 16 W/m	1750 lm/m	● 6500 K	20	120°	5	10	60/m	5
	LD-5630-300-20-CB			● 3200 K						
	LD-5630-300-65-ZB	12 VDC 16 W/m	1700 lm/m	● 6500 K	65					
	LD-5630-300-65-CB			● 3200 K						
	LD-RGB-150-20	12 VDC 7,2 W/m	450 lm/m	● RGB	20	120°	5	10	30/m	10
	LD-RGB-150-65			65						



ТаЅма LED FLASH 50 m
LED FLASH strip 50 m
Светоодиодная лента LED FLASH



LD-2835-300-20-ZB-50	12 VDC 6 W/m	750 lm/m	● 6500 K	20	120°	50 m	8 mm	60/m	5
LD-2835-300-20-NE-50			● 5000 K						
LD-2835-300-20-CB-50			● 3200 K						
LD-3528-300-20-CB-50	● 6500 K								
LD-3528-300-20-NE-50	12 VDC 4,8 W/m	300 lm/m	● 5000 K						
LD-3528-300-20-ZB-50			● 3200 K						



ТаЅма LED BIS
LED strip BIS
Светоодиодная лента BIS



LD-3528B-300-20-CB	12 VDC 4,8 W/m	300 lm/m	● 3200 K	20	120°	5	8	60/m	5	100
LD-3528B-300-20-ZB			● 6500 K							
LD-3528B-300-65-CB		280 lm/m	● 3200 K	65						
LD-3528B-300-65-ZB			● 6500 K							50



Profil GLAX nakładany mini
 GLAX profile mini surface mounted
 Профиль GLAX накладной мини

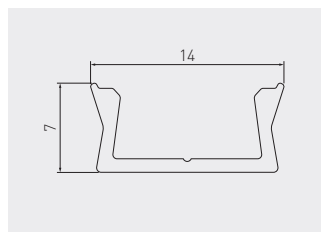

Taśma LED max 10 mm szerokości
 LED strip width max 10 mm
 Ширина светодиодной ленты не более 10 мм

	 L m			
PA-GLAXMNK-AL	2	profil profile профиль	srebrny silver серебристый	aluminium aluminium алюминий
PA-GLAXMNK3M-AL	3			
PA-OSMLGLAXM-00	2	ostonka mini cover mini крышка мини	mleczna frosted молочная	tworzywo plastic пластик
PA-OSMLGLAXM3M-00	3			
PA-OSTRGLAXM-00	2			
PA-OSTRGLAXM3M-00	3		transparentna transparent прозрачная	
PA-OSMLGLAXMK-00	2	ostonka kwadratowa cover square крышка квадратная	mleczna frosted молочная	
PA-OSMLGLAXMO-00		ostonka okrągła cover round крышка круглая		
PA-ZASGLAXMNK-00	-	zaślepka standard end cap standard заглушка стандартная	szary gray серый	ABS
PA-ZASGLAXMNKK-00	-	zaślepka kwadratowa end cap square заглушка квадратная		
PA-ZASGLAXMNKO-00	-	zaślepka okrągła end cap round заглушка круглая		

Ostonki / Covers / Крышки:

 PA-OSMLGLAXM-00
 PA-OSMLGLAXM3M-00

 PA-OSTRGLAXM-00
 PA-OSTRGLAXM3M-00

PA-OSMLGLAXMO-00

PA-OSMLGLAXMK-00

Zaślepki / End caps / Заглушки:



PA-ZASGLAXMNK-00

PA-ZASGLAXMNKK-00

PA-ZASGLAXMNKO-00

Profil GLAX nakładany
GLAX profile surface mounted
Профиль GLAX накладной

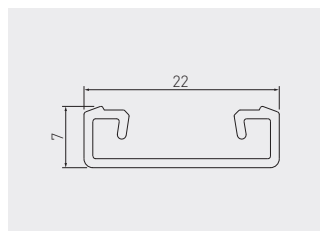

	 L m			
PA-GLAXNK-AL	2	profil profile профиль	srebrny silver серебристый	aluminium aluminium алюминий
PA-GLAXNK3M-AL	3			
PA-ZASGLAXNK-00	-	zaślepka end cap заглушка	szary gray серый	ABS

Ostonki / Covers / Крышки:



PA-OSMLGLAX-00
PA-OSMLGLAX3M-00

PA-OSTRGLAX-00
PA-OSTRGLAX3M-00

Zaślepki / End caps / Заглушки:





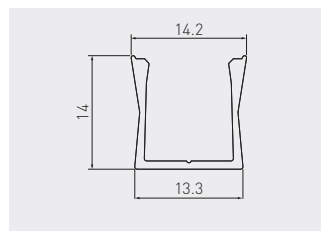

PA-ZASGLAXNK-00

Profil GLAX nakładany mini, wysoki
 Profile GLAX surface mounted mini, high
 Профиль GLAX накладной мини, высокий







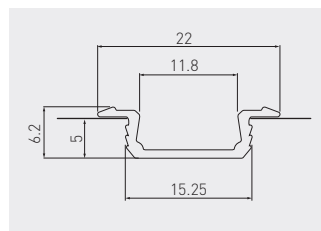

Brak widocznych punktów świetlnych
 Taśma LED max 10 mm szerokości
 No visible points of light
 LED strip width max 10 mm
 Нет видимых точек света
 Ширина светодиодной ленты не более 10 мм

	 L m			
PA-GLAXMNKW-AL	2	profil profile профиль	srebrny silver серебристый	aluminium aluminium алюминий
PA-OSMLGLAXM-00	2	ostonka mini cover mini крышка мини	mleczna frosted молочная	tworzywo plastic пластик
PA-OSTRGLAXM-00			transparentna transparent прозрачная	
PA-ZASGLAXMNKW-00	-	zaślepka end cap заглушка	szary gray серый	ABS



Profil GLAX wpuszczany
 Profile GLAX recessed
 Профиль LED GLAX врезной



	 L m			
PA-GLAX-AL	2	profil profile профиль	srebrny silver серебристый	aluminium aluminium алюминий
PA-GLAX3M-AL	3			
PA-OSMLGLAX-00	2	ostonka cover крышка	mleczna frosted молочная	tworzywo plastic пластик
PA-OSMLGLAX3M-00	3			
PA-OSTRGLAX-00	2		transparentna transparent прозрачная	
PA-OSTRGLAX3M-00	3			
PA-ZASGLAX-00	-	zaślepka end cap заглушка	szary gray серый	ABS

Ostonki / Covers / Крышки:



PA-OSMLGLAXM-00

PA-OSTRGLAXM-00

Zaślepka / End cap / Заглушка:

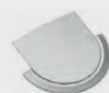

PA-ZASGLAX-00

Profil GLAX wpuszczany, wysoki
 Profile GLAX recessed, high
 Профиль LED GLAX врезной

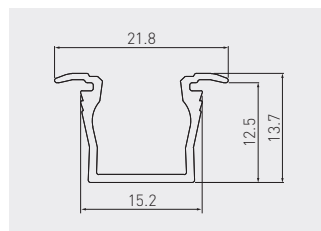





Brak widocznych punktów świetlnych
 Taśma LED max 10 mm szerokości
 No visible points of light
 LED strip width max 10 mm
 Нет видимых точек света
 Ширина светодиодной ленты не более 10 мм

	 L m			
PA-GLAXMW-AL	2	profil profile профиль	srebrny silver серебристый	aluminium aluminium алюминий
PA-OSMLGLAXM-00	2	ostonka mini cover mini крышка мини	mleczna frosted молочная	tworzywo plastic пластик
PA-OSMLGLAXMK-00		ostonka kwadratowa cover square крышка квадратная		
PA-OSTRGLAXM-00		ostonka mini cover mini крышка мини	transparentna transparent прозрачная	
PA-ZASGLAXMW-00	-	zaślepka standard end cap standard заглушка стандартная	szary gray серый	ABS
PA-ZASGLAXMWK-00	-	zaślepka kwadratowa end cap square заглушка квадратная		

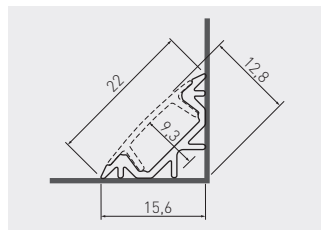

Profil GLAX kątowy
 GLAX corner profile
 Профиль GLAX угловой



	 L m		
PA-GLAXKT-AL	2	profil profile профиль	srebrny silver серебристый
PA-GLAXKT3M-AL	3		
PA-OSMLGLAX-00	2	ostonka cover крышка	mleczna frosted молочная
PA-OSMLGLAX3M-00	3		
PA-OSTRGLAX-00	3		transparentna transparent прозрачная
PA-OSTRGLAX3M-00	2		
PA-ZASGLAXKT-00	-	zaślepka end cap заглушка	szary gray серый

Ostonki / Covers / Крышки:

 PA-OSMLGLAX-00
 PA-OSMLGLAX3M-00

 PA-OSTRGLAX-00
 PA-OSTRGLAX3M-00

Zaślepka / End cap / Заглушка:





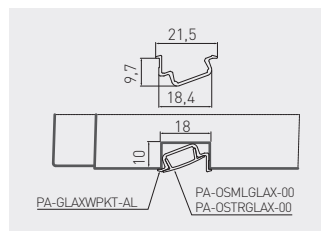

PA-ZASGLAXKT-00

Profil GLAX kątowy, wpuszczany
 Recessed corner profile GLAX
 Профиль GLAX угловой, врезной



Kąt świecenia 22°
 Beam angle 22°
 Угол свечения 22°

				
PA-GLAXWPKT-AL	2	profil profile профиль	srebrny silver серебристый	aluminium aluminium алюминий
PA-OSMLGLAX-00		ostonka cover крышка	mleczna frosted молочная	tworzywo plastic пластик
PA-OSTRGLAX-00			transparentna transparent прозрачная	

Ostonki / Covers / Крышки:



PA-OSMLGLAX-00



PA-OSTRGLAX-00

Profil GLAX kątowy, nakładany
 GLAX aluminium corner profile – surface mounted
 Профиль LED GLAX угловой, накладной

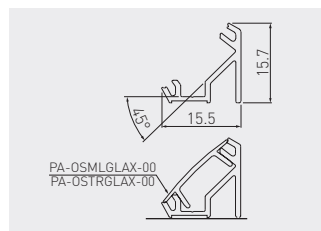

				
PA-GLAXNKKT-AL	2	profil profile профиль	srebrny silver серебристый	aluminium aluminium алюминий
PA-GLAXNKKT3M-AL	3			
PA-OSMLGLAX-00	2	ostonka cover крышка	mleczna frosted молочная	tworzywo plastic пластик
PA-OSMLGLAX3M-00	3		transparentna transparent прозрачная	
PA-OSTRGLAX-00	2			
PA-OSTRGLAX3M-00	3			
PA-OSMLGLAXT-00	2	ostonka trójkątna cover triangular крышка треугольная	mleczna frosted молочная	
PA-ZASGLAXNKKT-00	-	zaślepka standard end cap standard заглушка стандартная	szary gray серый	ABS
PA-ZASGLAXNKKT-00	-	zaślepka trójkątna end cap triangular заглушка треугольная		

Ostonki / Covers / Крышки:

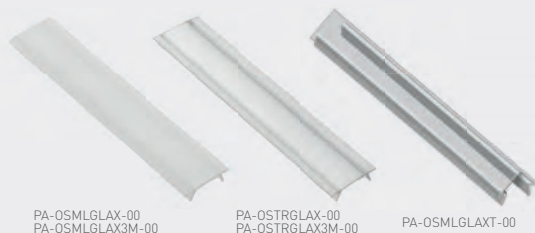
 PA-OSMLGLAX-00
 PA-OSMLGLAX3M-00

 PA-OSTRGLAX-00
 PA-OSTRGLAX3M-00

PA-OSMLGLAXT-00

Zaślepki / End caps / Заглушки:





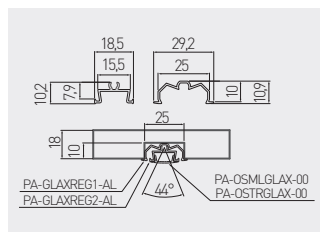

PA-ZASGLAXNKKT-00

PA-ZASGLAXNKKT-00

Profil GLAX z regulowanym kątem
 Profile GLAX with adjustable angle
 Профиль GLAX с регулировкой угла



					
PA-GLAXREG1-AL	2	profil profile профиль	srebrny silver серебристый	aluminium aluminium алюминий	
PA-GLAXREG2-AL					
PA-OSMLGLAX-00	2	osłonka cover крышка	mleczna frosted молочная	tworzywo plastic пластик	
PA-OSTRGLAX-00			transparentna transparent прозрачная		

Ostonki / Covers / Крышки:



PA-OSMLGLAX-00



PA-OSTRGLAX-00

Profil GLAX wieńcowy
Rim profile GLAX
Профиль GLAX, торцевой

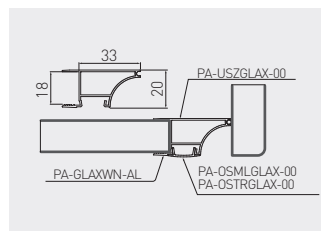

PA-GLAXWN-AL	2	profil profile профиль	srebrny silver серебристый	aluminium aluminium алюминий
PA-OSMLGLAX-00		ostonka cover крышка	mleczna frosted молочная	tworzywo plastic пластик
PA-OSTRGLAX-00			transparentna transparent прозрачная	
PA-USZGLAX-00N	10	uszczelka cord gasket уплотнитель	czarny black чёрный	EPDM

Ostonki / Covers / Крышки:



PA-OSMLGLAX-00



PA-OSTRGLAX-00

Uszczelka / Cord gasket / Уплотнитель







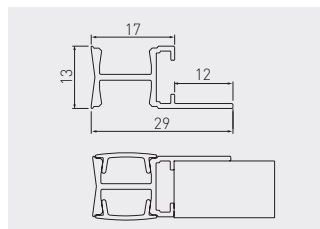

PA-USZGLAX-00N

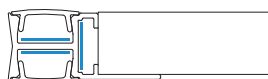
Profil GLAX półkowy mini
Shelf profile GLAX mini
Профиль GLAX полочный мини



Możliwość zastosowania 3 taśm LED
Possibility of using 3 LED strips
Возможность использования
3 светодиодных лент



	 m			
PA-GLAXMPK-AL	2	profil profile профиль	srebrny silver серебристый	aluminium aluminium алюминий
PA-OSMLGLAXM-00		ostonka mini cover mini крышка мини	mleczna frosted молочная	tworzywo plastic пластик
PA-OSTRGLAXM-00			transparentna transparent прозрачная	

Ostonki / Covers / Крышки:



PA-OSMLGLAXM-00



PA-OSTRGLAXM-00

Profil GLAX drążkowy
 GLAX rail profile
 Профиль-штанга GLAX

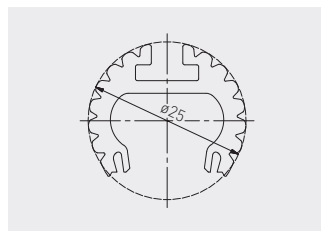





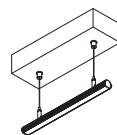
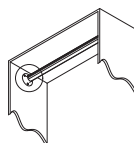

Możliwości montażu jako:

Assembly options as:

Варианты сборки:

- drążek w szafie
- rod in the closet
- стержень в шкафу
- oprawa zwieszana
- suspended luminaire
- подвесной светильник



	 m			
PA-GLAXDR-AL	2	profil profile профиль	srebrny silver серебристый	aluminium aluminium алюминий
PA-OSMLGLAX-00		ostonka cover крышка	mleczna frosted молочная	tworzywo plastic пластик
PA-OSTRGLAX-00			transparentna transparent прозрачная	
PA-ZASGLAXDR-00	-	zaślepka end cap заглушка	szary gray серый	ZnAl
PA-ROZGLAX-53	-	rozetka rail socket монтажный крепеж		
PA-ZAWGLAXDR-00	1,5	zawieszka hanger подвес для профиля	chrom chrome хром	stal steel сталь

Ostonki / Covers / Крышки:



PA-OSMLGLAX-00

PA-OSTRGLAX-00

Zaślepka / End cap
Заглушка



PA-ZASGLAXDR-00

Rozetka / Rail socket
Монтажный крепеж



PA-ROZGLAX-53

Zawieszka / Hanger
Подвес для профиля



PA-ZAWGLAXDR-00

Profil GLAX kątowy, nabijany, jednostronny
 GLAX aluminium edge profile – single-sided
 Профиль LED GLAX торцевой, односторонний

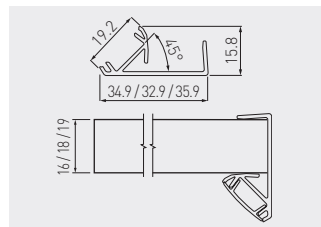

	BOARD mm	L m			
PA-GLAXNBJ2M16-AL	16	2	profil profile профиль	srebrny silver серебристый	aluminium aluminium алюминий
PA-GLAXNBJ3M16-AL	16	3			
PA-GLAXNBJ3M-AL	18	3			
PA-GLAXNBJ2M19-AL	19	2			
PA-GLAXNBJ3M19-AL	19	3			
PA-OSMLGLAX-00	-	2	ostonka cover крышка	mleczna frosted молочная	tworzywo plastic пластик
PA-OSMLGLAX3M-00	-	3		transparentna transparent прозрачная	
PA-OSTRGLAX-00	-	3			
PA-OSTRGLAX3M-00	-	2			

Ostonki / Covers / Крышки:



PA-OSMLGLAX-00
 PA-OSMLGLAX3M-00



PA-OSTRGLAX-00
 PA-OSTRGLAX3M-00

Profil GLAX, kątowy, nabijany, jednostronny (do wypełnienia obrzeżem)
 GLAX aluminium edge profile – single-sided (option to fill with matching edge banding)
 Профиль LED GLAX торцевой, кромочный, односторонний

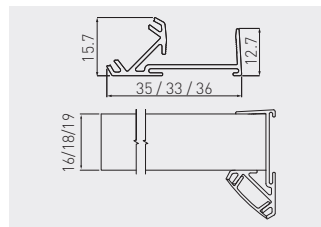

	BOARD mm	L m			
PA-GLAXNB JW2M16-AL	16	2	profil profile профиль	srebrny silver серебристый	aluminium aluminium алюминий
PA-GLAXNB JW3M16-AL	16	3			
PA-GLAXNB JW3M-AL	18	3			
PA-GLAXNB JW2M19-AL	19	2			
PA-GLAXNB JW3M19-AL	19	3			
PA-OSMLGLAX-00	-	2	ostonka cover крышка	mleczna frosted молочная	tworzywo plastic пластик
PA-OSMLGLAX3M-00	-	3		transparentna transparent прозрачная	
PA-OSTRGLAX-00	-	3			
PA-OSTRGLAX3M-00	-	2			

Ostonki / Covers / Крышки:



PA-OSMLGLAX-00
PA-OSMLGLAX3M-00



PA-OSTRGLAX-00
PA-OSTRGLAX3M-00

Profil GLAX kątowy, nabijany, dwustronny
 GLAX aluminium edge profile – double sided
 Профиль LED GLAX торцевой, двухсторонний

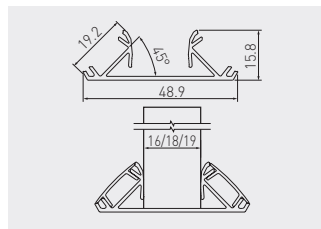

	 BOARD mm	 L m			
PA-GLAXNBD2M16-AL	16	2	profil profile профиль	srebrny silver серебристый	aluminium aluminium алюминий
PA-GLAXNBD3M16-AL	16	3			
PA-GLAXNBD3M-AL	18	3			
PA-GLAXNBD2M19-AL	19	2			
PA-GLAXNBD3M19-AL	19	3			
PA-OSMLGLAX-00	-	2	osłonka cover крышка	mleczna frosted молочная	tworzywo plastic пластик
PA-OSMLGLAX3M-00	-	3		transparentna transparent прозрачная	
PA-OSTRGLAX-00	-	3			
PA-OSTRGLAX3M-00	-	2			

Ostonki / Covers / Крышки:



PA-OSMLGLAX-00
 PA-OSMLGLAX3M-00



PA-OSTRGLAX-00
 PA-OSTRGLAX3M-00

Profil GLAX kątowy, nabijany, dwustronny (do wypełnienia obrzeżem)
 GLAX aluminium edge profile – double sided (option to fill with matching edge banding)
 Профиль LED GLAX торцевой, кромочный, двухсторонний

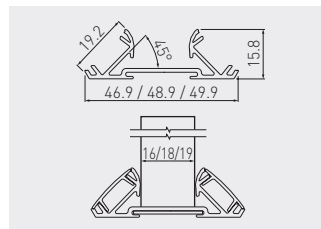

	BOARD mm	L mm			
PA-GLAXNBDW2M16-AL	16	2	profil profile профиль	srebrny silver серебристый	aluminium aluminium алюминий
PA-GLAXNBDW3M16-AL	16	3			
PA-GLAXNBDW3M-AL	18	3			
PA-GLAXNBDW2M19-AL	19	2			
PA-GLAXNBDW3M19-AL	19	3			
PA-OSMLGLAX3M-00	-	3	ostonka cover крышка	mleczna frosted молочная	tworzywo plastic пластик
PA-OSTRGLAX3M-00	-		transparentna transparent прозрачная		

Ostonki / Covers / Крышки:









PA-OSMLGLAX3M-00

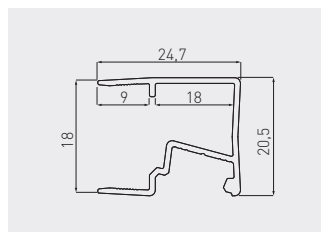

PA-OSTRGLAX3M-00

Profil GLAX kątowy, nabijany, wąski, jednostronny
 Corner profile GLAX, one-sided, edge mounted
 Профиль GLAX угловой, накладной, узкий, односторонний



				
PA-GLAXMNBW3M-AL	3	profil profile профиль	srebrny silver серебристый	aluminium aluminium алюминий
PA-OSMLGLAXM3M-00		ostonka mini cover mini крышка мини	mleczna frosted молочная	tworzywo plastic пластик
PA-OSTRGLAXM3M-00			transparentna transparent прозрачная	

Ostonki / Covers / Крышки:









PA-OSMLGLAXM3M-00

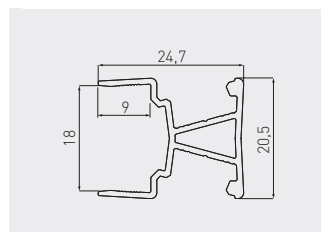

PA-OSTRGLAXM3M-00

Profil GLAX kątowy, nabijany, wąski, dwustronny
 Corner profile GLAX, narrow, two-sided
 Профиль GLAX угловой, накладной, узкий двусторонний



				
PA-GLAXMNBW3M-AL	3	profil profile профиль	srebrny silver серебристый	aluminium aluminium алюминий
PA-OSMLGLAXM3M-00		osłonka mini cover mini крышка мини	mleczna frosted молочная	tworzywo plastic пластик
PA-OSTRGLAXM3M-00			transparentna transparent прозрачная	

Ostonki / Covers / Крышки:



PA-OSMLGLAXM3M-00



PA-OSTRGLAXM3M-00

Profil GLAX wpuszczany z poliwęglanu
 Recessed polycarbonate profile GLAX
 Профиль GLAX врезной из поликарбоната

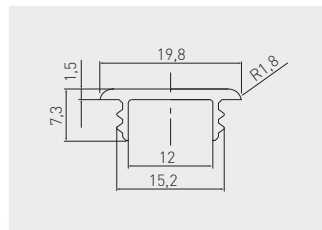

			
PW-PC31209-00N	2	mleczna / frosted / молочная	tworzywo plastic пластик
PW-PC61209-00		transparentna / transparent / прозрачная	



Oprawa VASCO nakładana / wpuszczana
 Fixture Vasco surface mounted / recessed
 Светильник Vasco накладной / врезной



LD-VA24CB-10	130 lm	● 3000 K	biały połysk white gloss белый глянец	tworzywo plastic пластик
LD-VA24NE-10		● 4000 K		
LD-VA24ZB-10		● 6000 K		
LD-VA24CB-20		● 3000 K	czarny połysk black gloss чёрный глянец	
LD-VA24NE-20		● 4000 K		
LD-VA24ZB-20		● 6000 K		
LD-VA24CB-53		● 3000 K	aluminium aluminium алюминий	
LD-VA24NE-53		● 4000 K		
LD-VA24ZB-53		● 6000 K		

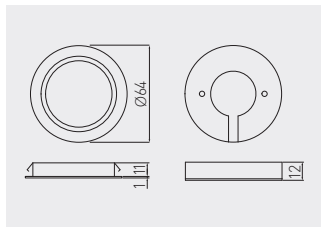

Oprawa LUMINO
 Fixture LUMINO
 Светильник LUMINO



LD-LU16CB-10	70-85 lm	● 2700 K	biały połysk white gloss белый глянец	tworzywo plastic пластик
LD-LU16NE-10		● 4000 K		
LD-LU16ZB-10		● 6500 K		
LD-LU16CB-20		● 2700 K	czarny połysk black gloss чёрный глянец	
LD-LU16NE-20		● 4000 K		
LD-LU16ZB-20		● 6500 K		
LD-LU16CB-53		● 2700 K	aluminium aluminium алюминий	
LD-LU16NE-53		● 4000 K		
LD-LU16ZB-53		● 6500 K		

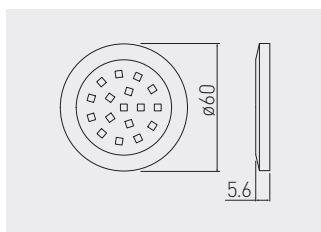

Оправа JOVITA
 Fixture JOVITA
 Светильник JOVITA

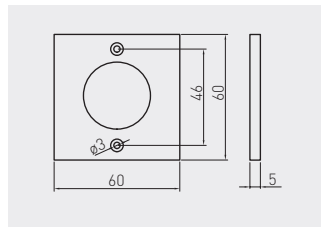

LD-KJVCOB-CB	200 lm	● 3000 K	aluminium aluminium алюминий	aluminium aluminium алюминий
LD-KJVCOB-ZB		● 6400 K		



Оправа JOVITA
 Fixture JOVITA
 Светильник JOVITA

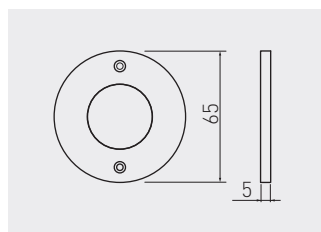

LD-OJVCOB-CB	200 lm	● 3000 K	aluminium aluminium алюминий	aluminium aluminium алюминий
LD-OJVCOB-ZB		● 6400 K		



Оправа JOVITA
 Fixture JOVITA
 Светильник JOVITA

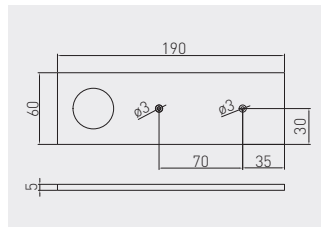

LD-PJVCOB-CB	200 lm	● 3000 K	aluminium	aluminium
LD-PJVCOB-ZB		● 6400 K	aluminium алюминий	aluminium алюминий



Оправа LUGO
 Fixture LUGO
 Светильник LUGO

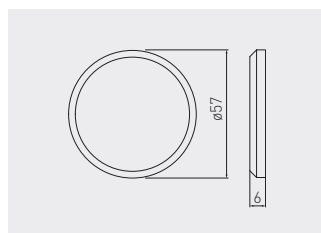

LD-LCG119-53	110 lm	● 3000 K	aluminium	tworzywo plastic пластик
LD-LUG119-53		● 6400 K	aluminium алюминий	
LD-LCG119-40		● 3000 K	chrom	
LD-LUG119-40		● 6400 K	chrome хром	
LD-LCG119-52		● 3000 K	satyna	
LD-LUG119-52		● 6400 K	satin сатин	



Оправа CASTELLO
 Fixture CASTELLO
 Светильник CASTELLO

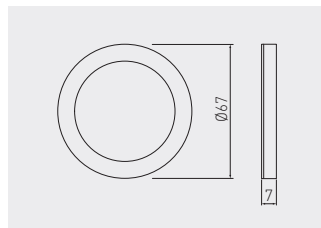

LD-CSN36CB-53	180 lm	● 3000 K	aluminium	tworzywo
LD-CSN36ZB-53		● 6500 K	aluminium алюминий	plastic пластик



Оправа CASTELLO z włącznikiem
 Fixture CASTELLO with switch
 Светильник CASTELLO с выключателем

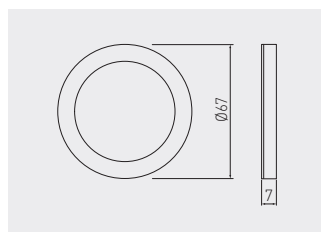

LD-CS36CB-53	180 lm	● 3200 K	aluminium	tworzywo
LD-CS36NE-53		● 4000 K	aluminium алюминий	plastic пластик
LD-CS36ZB-53		● 6200 K		



Оправа ESTELLA
 Fixture ESTELLA
 Светильник ESTELLA

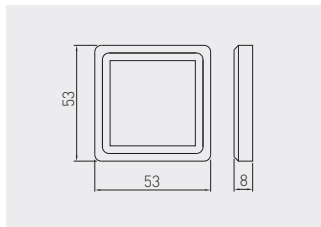

LD-ES21ZB-53	110 lm	6400 K	aluminium aluminium алюминий	tworzywo plastic пластик



Оправа VEGAS
 Fixture VEGAS
 Светильник VEGAS

NEW

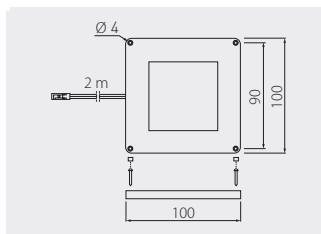

LD-VE15CB-53	140 lm	3000 K	aluminium aluminium алюминий	tworzywo / aluminium plastic / aluminium пластмасса / алюминий
LD-VE15NE-53	145 lm	4000 K		
LD-VE15ZB-53	150 lm	6400 K		



Оправа VEGAS 2 w 1
 Fixture VEGAS 2 in 1
 Светильник VEGAS 2 в 1

NEW

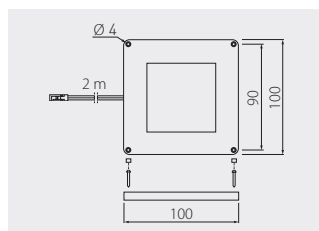

Powiązane produkty:
 Włącznik, regulator światła
 AE-WLKON-20

Related products:
 Switch, colour temperature controller
 AE-WLKON-20

Связанных с ними продуктов:
 Выключатель, регулятор цветовой температуры
 AE-WLKON-20



LD-VE15CBZB-53	140 lm	● 3000 K - ● 6400 K	aluminium aluminium алюминий	tworzywo / aluminium plastic / aluminium пластмасса / алюминий



Оправа CALDAS
 Fixture CALDAS
 Светильник CALDAS

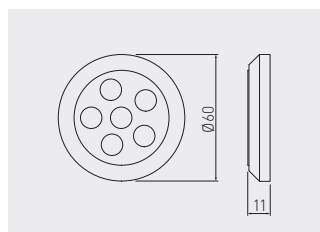

LD-CD06ZB-53	190 lm	● 6400 K	aluminium aluminium алюминий	tworzywo plastic пластик



Oprawa ISLA
Fixture ISLA
Светильник ISLA

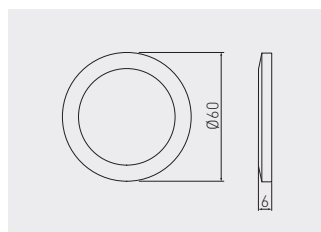

LD-IS09CB-53	56 lm	● 3200 K	aluminium aluminium алюминий	tworzywo plastic пластик
LD-IS09NE-53		● 4000 K		
LD-IS09ZB-53		● 6400 K		



Oprawa ALVARO wpuszczana
Recessed fixture ALVARO
Врезной светильник ALVARO

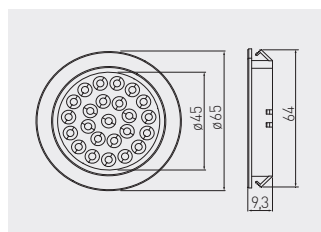

LD-AL24CB-53	130 lm	● 3000 K	aluminium aluminium алюминий	tworzywo plastic пластик
LD-AL24NE-53		● 4000 K		
LD-AL24ZB-53		● 6400 K		



Oprawa TREVI
Fixture TREVI
Светильник TREVI

NEW

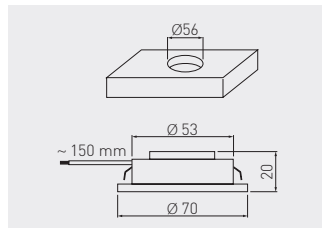

LD-TR24CB-53	300 lm	● 3000 K	aluminium aluminium алюминий	tworzywo plastic пластик						
LD-TR24ZB-53										

Oprawa trójkątna z włącznikiem
Triangle fixture with switch
Треугольный светильник с выключателем

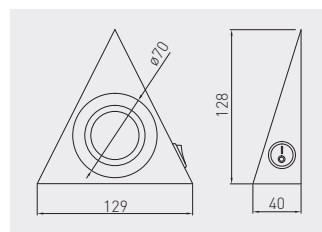

LD-OPT30S-53N	100 lm	● 3000 K	aluminium / aluminium / алюминий	stal steel сталь
LD-OPT60S-53N		● 6400 K		
LD-OPT30S-51N		● 3000 K	stal szorstkowana / brushed steel / шлифованная сталь	
LD-OPT60S-51N		● 6400 K		
LD-OPT30S-52N		● 3000 K	satyna / satin / сатин	
LD-OPT60S-52N		● 6400 K		

--	--	--	--	--	--	--	--	--	--	--

Zestaw opraw trójkątnych z włącznikiem
 Triangle fixture kit with switch
 Комплект треугольных светильников с выключателем

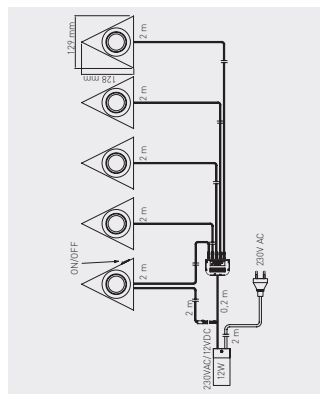

LD-Z50TCB-51	5 x 100 lm	3000 K	stal szcztokowana brushed steel шлифованная сталь	stal, tworzywo steel, plastic сталь, пластмасса				
	AC 220-240V 50-60 Hz	5 x 1,6 W	120°	5x18	2 m	ON OFF	mini AMP	x10

Zestaw opraw CASTELLO z włącznikiem
 Fixture kit with switch CASTELLO
 Комплект светильников CASTELLO с выключателем

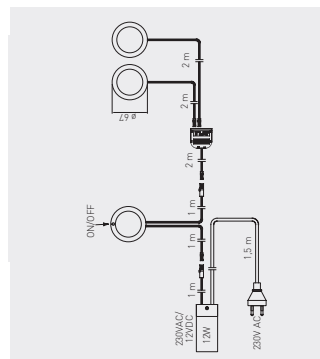

LD-Z3CSCB-53	3 x 180 lm	3000 K	aluminium / aluminium / алюминий	tworzywo / plastic / пластик				
	AC 220-240V 50-60 Hz	x3 2,8 W	120°	3x36	2 m	ON OFF	mini AMP	x30

Zestaw opraw CASTELLO z włącznikiem
 Fixture kit CASTELLO with switch
 Комплект светильников CASTELLO с выключателем

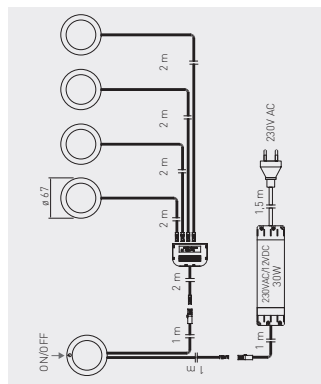

LD-Z5CSCB-53	5x180 lm	3000 K	aluminium / aluminium / алюминий	tworzywo / plastic / пластик



Zestaw opraw LUGO
 Fixture kit LUGO
 Комплект светильников LUGO

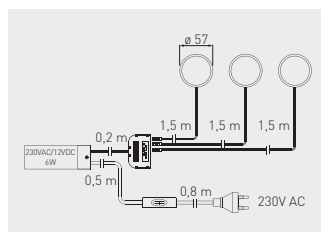

LD-LCG319-53	3x110 lm	3000 K	aluminium / aluminium / алюминий	tworzywo plastic / пластик	10
LD-LUG319-53		6400 K			20
LD-LCG319-40		3000 K	chrom / chrome / хром		16
LD-LUG319-40		6400 K			20
LD-LCG319-52		3000 K	satyna / satin / сатин		20
LD-LUG319-52		6400 K			20



Zestaw opraw BARRI
 Fixture kit BARRI
 Комплект светильников BARRI

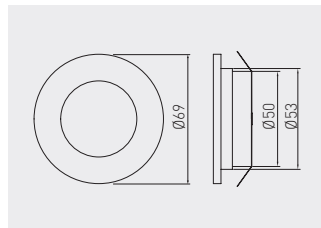

LD-OBP27CB-53	3x80 lm	2700 K	aluminium aluminium	aluminium, tworzywo aluminium, plastic
LD-OBP27ZB-53		6400 K	алюминий	алюминий, пластмасса



Zestaw opraw MARBELLA
 Fixture kit MARBELLA
 Комплект светильников MARBELLA

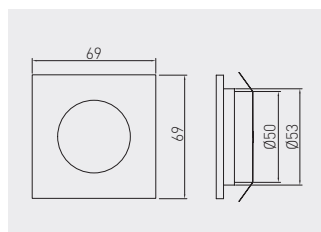
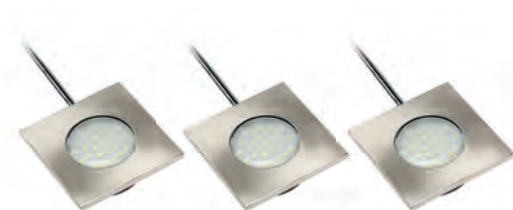

LD-KWP27CB-53	3x80 lm	2700 K	aluminium aluminium	aluminium, tworzywo aluminium, plastic
LD-KWP27ZB-53		6400 K	алюминий	алюминий, пластмасса



Listwa LED z zasilaczem
LED strip with power supply
Светодиодная планка с трансформатором

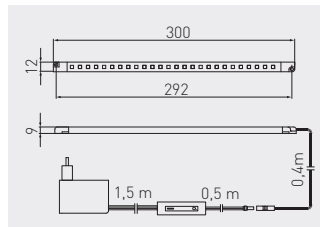

LD-LL27CB-00	140 lm	3000 K	chrom	tworzywo plastic пластик
LD-LL27ZB-00		6400 K	chrom chrome хром	



Oprawa OVIEDO wpuszczana
Recessed fixture OVIEDO
Врезной светильник OVIEDO

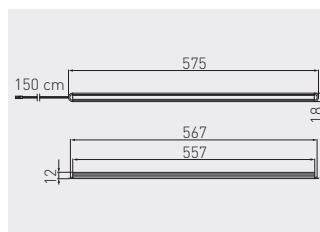

LD-WL2457-53	90 lm	6400 K	aluminium aluminium алюминий	aluminium, tworzywo aluminium, plastic алюминий, пластмасса



Oprawa FRAGA podszafkowa z włącznikiem
 Cabinet fixture with switch FRAGA
 Светильник под шкафчики FRAGA с выключателем

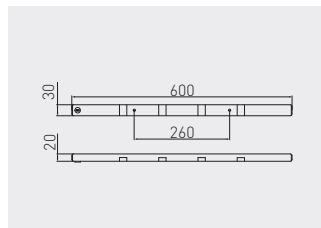
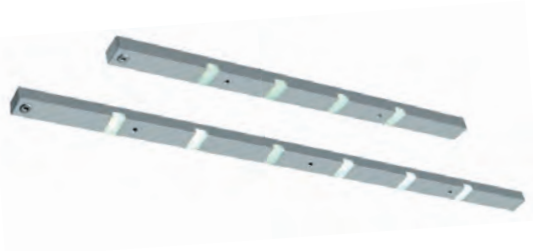

LD-OP408C-53	3 W	90 lm	● 6400 K	aluminium aluminium алюминий	aluminium, tworzywo aluminium, plastic алюминий, пластмасса
LD-OP608C-53	4,1 W	135 lm			



Oprawa ROTA podszafkowa
 Cabinet ROTA fixture
 Светильник ROTA под шкафчики

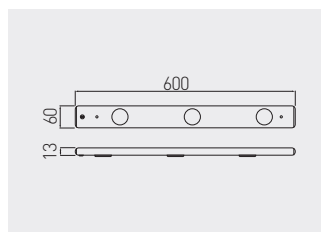

LD-OP456C-53	4,2 W	230 lm	● 6400 K	aluminium aluminium алюминий	aluminium, tworzywo aluminium, plastic алюминий, пластмасса
LD-OP609C-53	5,5 W	310 lm			



Oprowa OPD podszafkowa
Under cabinet LED lamp fixture OPD
Светодиодный светильник OPD под шкафчик

NEW

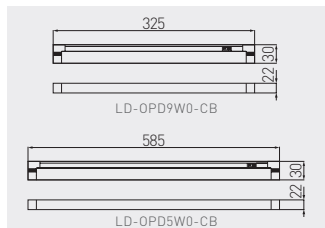

LD-OPD5W0-CB	5 W	300 lm	● 3000 K	chrom	metal
LD-OPD9W0-CB	9 W	350 lm		chrom хром	metal металл



Oprowa SORIA z czujnikiem zbliżeniowym
Fixture with proximity sensor SORIA
Светильник с датчиком приближения SORIA

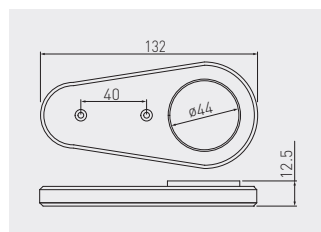

LD-SR16CB-53	90-110 lm	● 3000 K	aluminium aluminium алюминий	aluminium aluminium алюминий
LD-SR16NE-53		● 4000 K		
LD-SR16ZB-53		● 6400 K		



Оправа FOCUS на wysięgniku
 Fixture with arm FOCUS
 Светильник типа „дуга” FOCUS

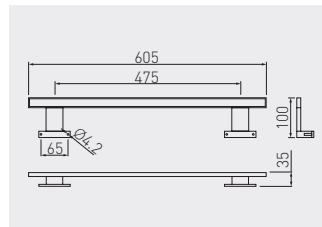

LD-FO120CB-40	740 lm	● 3000 K	chrom chrome хром	aluminium, tworzywo aluminium, plastic алюминий, пластмасса
LD-FO120ZB-40		● 6400 K		



Оправа RADIUS на wysięgniku
 Fixture with arm RADIUS
 Светильник типа „дуга” RADIUS

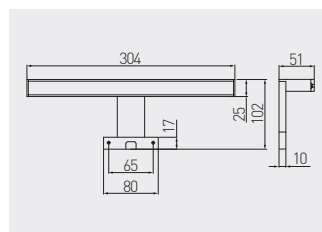

LD-RA60CB-40	300 lm	● 3000 K	chrom chrome хром	aluminium, tworzywo aluminium, plastic алюминий, пластмасса
LD-RA60ZB-40	350 lm	● 6400 K		



Оправа MAXIMUS на wysięgniku
 Fixture with arm MAXIMUS
 Светильник типа „дуга” MAXIMUS

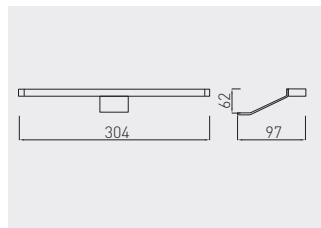

LD-MAX60CB-40N	160 lm	● 3000 K	chrom chrome	aluminium, tworzywo aluminium, plastic алюминий, пластмасса
LD-MAX60ZB-40N		● 6400 K	хром	



Оправа COSTA на wysięgniku
 Fixture with arm COSTA
 Светильник типа „дуга” COSTA

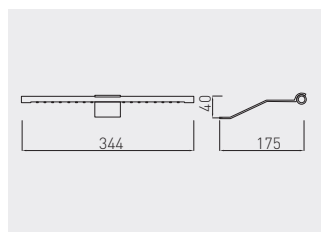

LD-CO20CB-53	100 lm	● 3000 K	aluminium aluminium	aluminium, tworzywo aluminium, plastic алюминий, пластмасса
LD-CO20ZB-53		● 6400 K	алюминий	



Оправа ABELLA na wysięgniku
 Fixture with arm ABELLA
 Светильник типа „дуга” ABELLA

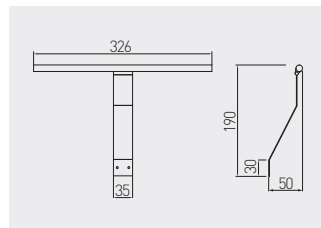

LD-AB18CB-53	460 lm	● 3000 K	aluminium aluminium алюминий	stal, aluminium, tworzywo steel, aluminium, plastic сталь, алюминий, пластмасса
LD-AB18ZB-53		● 6400 K		



Оправа EVITA na wysięgniku
 Fixture with arm EVITA
 Светильник типа „дуга” EVITA

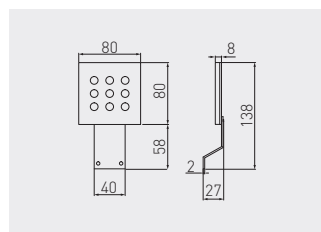

LD-EIW09CB-CZ	120 lm	● 3000 K	czarny / black / чёрный	aluminium, tworzywo aluminium, plastic алюминий, пластмасса



Оправа NOELIA на wysięgniku
 Fixture with arm NOELIA
 Светильник типа „дуга” NOELIA

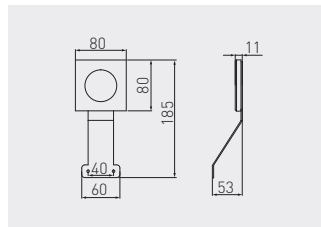

LD-NO24CB-00	330 lm	● 3000 K	aluminium aluminium алюминий	aluminium, tworzywo aluminium, plastic алюминий, пластмасса
LD-NO24ZB-00		● 6400 K		



Оправа FIDELIA на wysięgniku
 Fixture with arm FIDELIA
 Светильник типа „дуга” FIDELIA

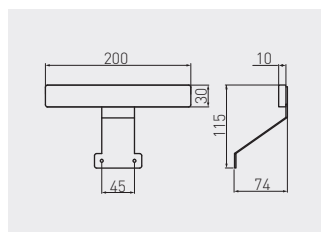

LD-FL36CB-00	155 lm	● 3000 K	aluminium aluminium алюминий	aluminium, tworzywo aluminium, plastic алюминий, пластмасса
LD-FL36ZB-00	165 lm	● 6400 K		



Oprawa CALDERON na wysięgniku
 Fixture with arm CALDERON
 Светильник типа „дуга” CALDERON

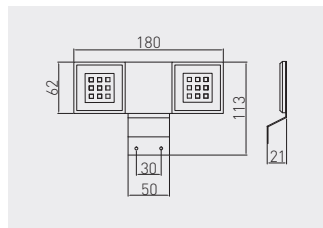

LD-NKW18CB-40	270lm	● 3000 K	chrom	stal, tworzywo
LD-NKW18ZB-40		● 6400 K	chrome хром	steel, plastic сталь, пластмасса



Oprawa COMA bezprzewodowa
 Wireless fixture COMA
 Беспроводной светильник COMA



LD-IRUSB-53

LD-PIRUSB-53

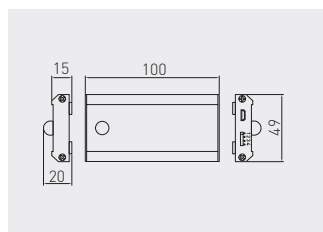

Dodatkowy przewód USB (do ładowania) - 0,5 m w komplecie
 Additional 0,5m USB cable (for charging)
 Дополнительный кабель USB (для зарядки) - 0,5 m

LD-IRUSB-53	40-50 lm	● 4000 K	Czujnik zbliżeniowy IR, jedno- lub dwu-biegowy Proximity sensor IR, single or double-pole Датчик движения IR, одно- и многофункциональный	aluminium aluminium алюминий	metal, tworzywo metal, plastic металл, пластик
LD-PIRUSB-53			Czujnik ruchu PIR, jednobiegowy Proximity sensor IR, single-pole Датчик движения PIR, однофункциональный		



Lampka CHICAGO z portem USB
 Bed lamp with USB CHICAGO
 Гибкая лампа с USB-разъемом CHICAGO

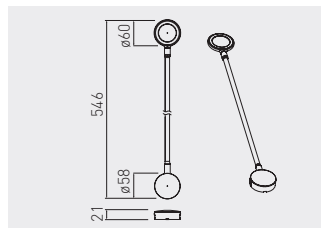

Wymaga zasilacza 12 V, 30 W
 Requires 12 V, 30 W power supply
 Требуется блок питания 12 В, 30 Вт

LD-CHIC16NE-10		120 lm	● 4000 K	biały / white / белый	stal, tworzywo steel, plastic
LD-CHIC16NE-20				czarny / black / чёрный	stal, tworzywo steel, plastic



Lampka BOSTON
 Lamp BOSTON
 Лампа BOSTON

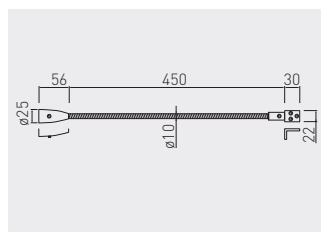

Wymaga zasilacza 12 V, 6 W
 Requires 12 V, 6 W power supply
 Требуется блок питания 12 В, 6 Вт

LD-BOS1CBWG-53		90 lm	● 3000 K	aluminium aluminium алюминий	stal, aluminium, tworzywo steel, aluminium, plastic
LD-BOS1CBWB-53					stal, aluminium, tworzywo steel, aluminium, plastic



Klip plastikowy LED do półek
Plastic LED clip for shelves
Пластиковая клипса LED для стеклянных полок

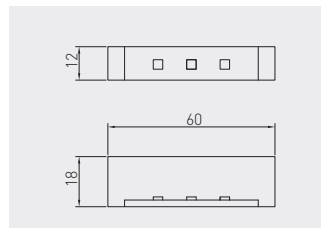

LD-KLPCB-00N	10 lm	● 3200 K	tworzywo plastic пластик
LD-KLPNB-00N	-	niebieski / blue / синий	
LD-KLPZB-00N	12 lm	● 6200 K	



Klip metalowy LED do półek
Metal LED clip for shelves
Металлическая клипса LED для стеклянных полок

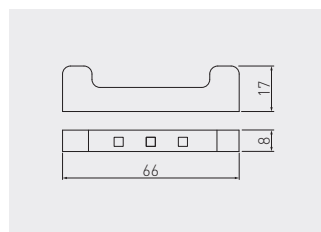





LD-3SKL-CBN	10 lm	● 3200 K	stal steel
LD-3SKL-NBN	-	niebieski / blue / синий	
LD-3SKL-ZBN	12 lm	● 6200 K	

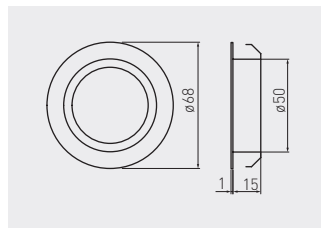

Оправа punktowa wpuszczana
 Recessed spot fixture
 Точечный светильник, врезной



			
OM-OPW000-60	max.20 W	złoto / gold / золото	stal steel
OM-OPW000-61		stare złoto / antique gold / старое золото	stal steel



Zestaw opraw halogenowych
Halide lamp fixture set
Комплект галогенных светильников

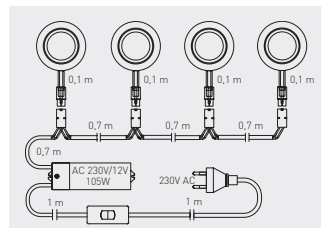

OM-ZH4200-53	max.5x20 W	aluminium / aluminium / алюминий	stal, tworzywo steel, plastic
OM-ZH4200-60		złoto / gold / золото	сталь, пластмасса



Zestaw opraw halogenowych
Halide lamp fixture set
Комплект галогенных светильников

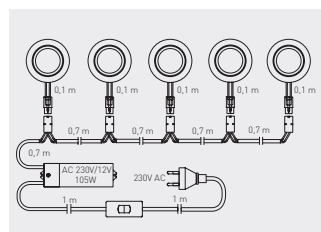

OM-ZH5200-53	max.5x20 W	aluminium / aluminium / алюминий	stal, tworzywo steel, plastic
OM-ZH5200-60		złoto / gold / золото	сталь, пластмасса



Zasilacz LED

Power supply

Блок питания для светодиодных светильников

			
LD-ZAS06W-30N	max 6 W	tworzywo plastic пластик	 107 x 39 x 25
LD-ZAS12W-30N	max 12 W		 122 x 45 x 25
LD-ZAS15W-30N	max 15 W		 122 x 45 x 25
LD-ZAS30W-30N	max 30 W		 169 x 48 x 31
LD-ZAS50W-30N	max 50 W		 169 x 48 x 31
LD-ZAS75W-30	max 75 W		 180 x 52 x 30



			
LD-ZAS150-NW	max 150 W	aluminium aluminium алюминий	 160 x 98 x 50
LD-ZAS350-NW	max 350 W		 197 x 98 x 50



Zasilacz LED puszkowy
LED power supply
Светодиодный трансформаторLED

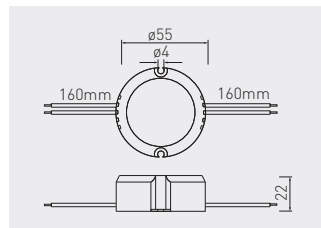

		
LD-ZASPU15W-30N	15 W	tworzywo / plastic / пластик



Układ zasilający LED SLIM, super cienki
 LED SLIM power supply set, ultra-thin
 Блок питания LED SLIM, сверхтонкий

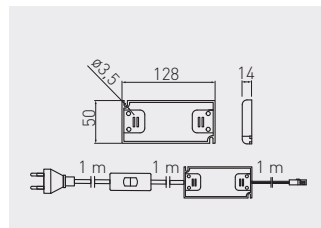

LD-SZA06W-MA	6 W	tworzywo / plastic / пластик	100
LD-SZA15W-MA	15 W		50
LD-SZA30W-MA	30 W		25
LD-SZA50W-MA	50 W		



Układ zasilający LED SLIM
 LED SLIM slim power supply set
 Блок питания LED SLIM

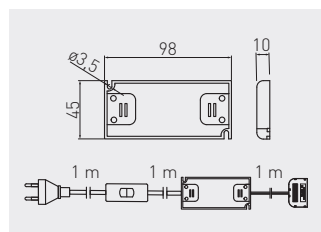

LD-SZA06W-24	6 W	tworzywo / plastic / пластик	100
LD-SZA15W-24	15 W		50



Układ zasilający do klipów LED 5-punktowy
 Power supply set for 5 LED clips
 Блок питания для светодиодных клипс, 5 разъёмов

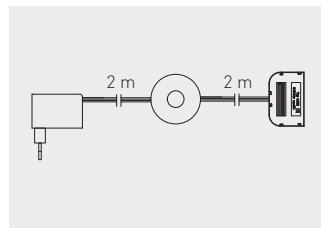

LD-ZSKL15-00

tworzywo / plastic / пластик



Układ zasilający
 Power supply set
 Блок питания

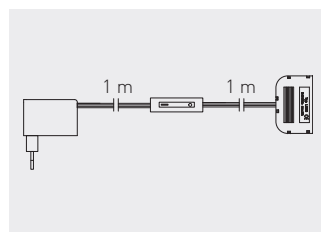

LD-ZWND6W-10

max 6 W

LD-ZWND12-10

max 12 W

tworzywo / plastic / пластик



Układ zasilający z przewodami bez włącznika i dystrybutorem 6x mini amp

Power supply without switch, with 6x mini AMP distributor

Блок питания с проводами и дистрибьютором 6х мини амр, без выключателя



LD-ZZAS06KD6	6 W	tworzywo / plastic / пластик
LD-ZZAS12KD6	12 W	
LD-ZZAS15KD6	15 W	
LD-ZZAS30KD6	30 W	

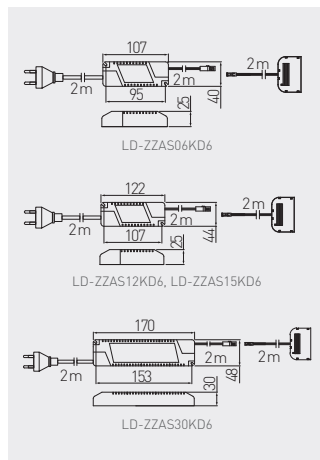

Transformator elektroniczny do żarówek halogenowych

Electronic power supply for halogen lamp

Электронный трансформатор для галогенной лампы



TE-600000-30	max 60 W	tworzywo / plastic / пластик
TE-150000-30	max 150 W	
TE-200000-30	max 200 W	

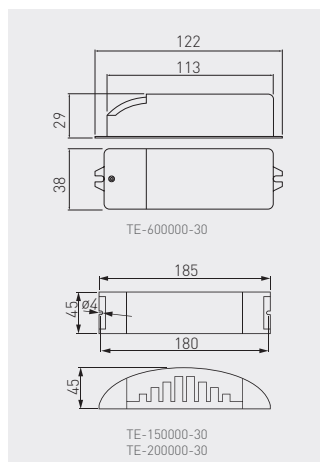

Kontroler RGB mini z pilotem
Mini RGB controller with remote
Миниконтроллер RGB с пультом

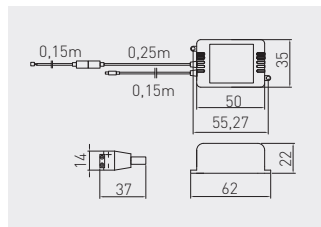

LD-KONMINI-RGB	RGB	tworzywo / plastic / пластик



Kontroler RGB z pilotem
RGB controller with remote
RGB контроллер с пультом

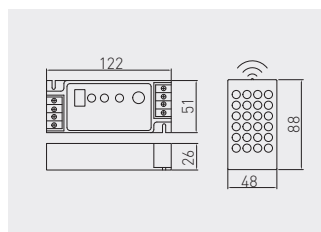

LD-KONRGRB-00	RGB	tworzywo / plastic / пластик



Zestaw RGB - kontroler, zasilacz LED 6W, pilot i dystrybutor
 RGB kit - RGB controller, power supply, remote and distributor
 Комплект RGB – контролер, трансформатор 6W, пульт, дистрибьютор

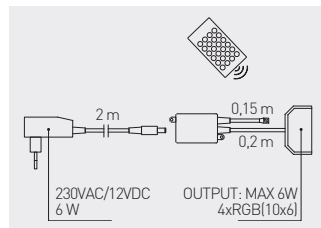

LD-ZAC6WDE-RGB	RGB	tworzywo / plastic / пластик



Zestaw RGB, taśma LED 5 m, kontroler, zasilacz, pilot
 RGB-set, LED band 5 m, RGB controller, LED-transformator, pilot
 Комплект RGB, лента LED 5 м, контролер, трансформатор, пульт

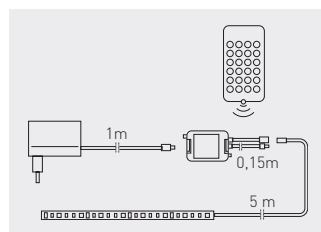

LD-ZL5RGB150-00	RGB	tworzywo / plastic / пластик



Ładowarka indukcyjna z zasilaczem
 Wireless charger with power supply
 Беспроводное зарядное устройство с блоком питания

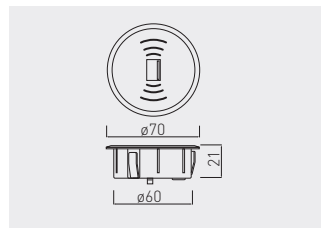

		
AE-ZUSB-20	czarny black чёрный	tworzywo plastic пластмасса



Ładowarka indukcyjna
 Wireless charger
 Беспроводное зарядное устройство

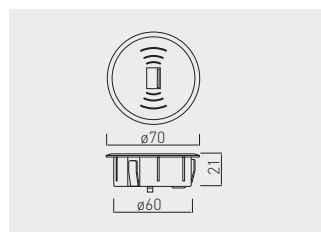

		
AE-USBCH-20	czarny black чёрный	tworzywo plastic пластмасса



Ładowarka bezprzewodowa, podblatowa z zasilaczem
 Wireless surface charger
 Беспроводное зарядное устройство, под столешницу

NEW

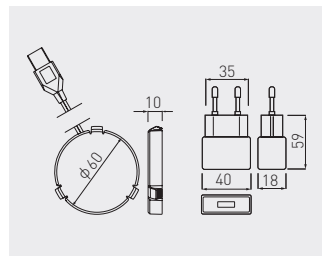

AE-ZLADPOD-20	czarny black чёрный	tworzywo plastic пластмасса



Włącznik bezdotkowy
 Touchless switch
 Бесконтактный датчик

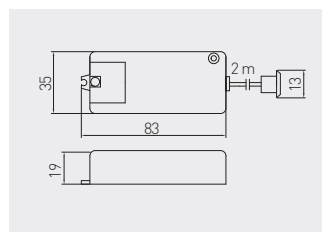



AE-WBEZDC-10S	dwubiegowy two-pole двухфункциональный	tworzywo plastic пластик
AE-WBEZDB-10S	jednobiegowy single-pole однофункциональный	

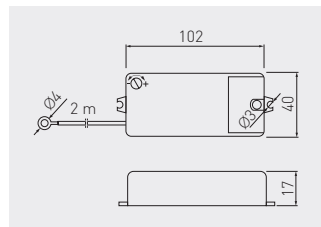

Włącznik dotykowy pod śrubę
Touch switch under screw
Сенсорный выключатель под винт

NEW





	
AE-WBEZDK15-10	tworzywo plastic пластмасса

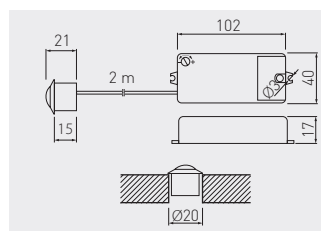

Włącznik z czujnikiem ruchu PIR
Switch with PIR motion detector
Выключатель с датчиком движения PIR

NEW



	
AE-WBEZDPIR-10	tworzywo plastic пластмасса



Włącznik z dwoma sensorami ruchu PIR II
 Switch with two PIR II motion sensors
 Выключатель с двумя датчиками движения PIR II

NEW

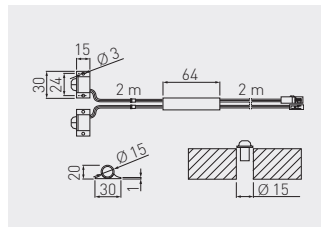



	
AE-WBEZDPIR2-20	tworzywo plastic / пластмасса

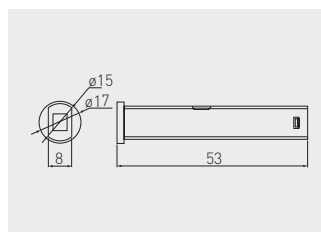

Włącznik bezdotykowy uniwersalny 3 w 1
 3 in 1 all-purpose touchless switch
 Бесконтактный выключатель 3 в 1





		
AE-WBBUNI-10DIM	biały / white / белый	tworzywo plastic / пластик
AE-WBCUNI-10DIM	czarny / black / чёрный	

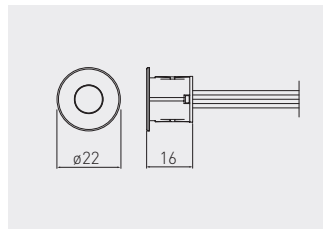

Włącznik dotykowy ściemniający
Dimmable touch switch
Выключатель с регулятором яркости



		
AE-WDSB-10DIM	biały / white / белый	tworzywo plastic пластик
AE-WDSC-10DIM	czarny / black / чёрный	



Włącznik dotykowy ściemniający
Dimmable touch switch
Выключатель с регулятором яркости

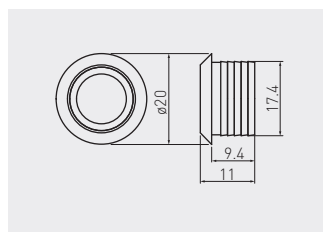

		
AE-WBEZD-NB	chrom chrome хром	tworzywo plastic пластик



Włącznik podblatowy
Countertop switch
Выключатель под столешницу

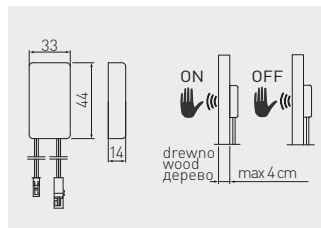

Grubość blatu max 40 mm
Countertop thickness max 40 mm
Толщина столешницы макс. 40 мм

	
AE-WPDRW-00	tworzywo / plastic / пластик



Włącznik do taśm LED montowany w profil
Switch for LED strips mounted in profile
Выключатель для ленты LED

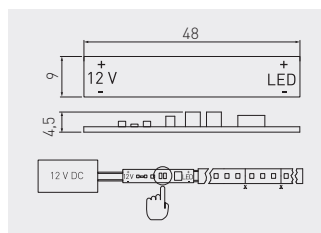

				
AE-WLPR-60	-	biały white белый	płytko elektroniczna circuit board электронная плата	1000
AE-WLPR-60P2	2 m			500



Włącznik kotykowski
Switch
Выключатель кнопочный

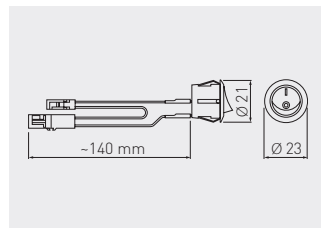

AE-WLB01-10	biały / white / белый	tworzywo plastic / пластик
AE-WLC01-20	czarny / black / чёрный	



Włącznik, regulator światła
Switch, colour temperature controller
Выключатель, регулятор цветовой температуры

NEW

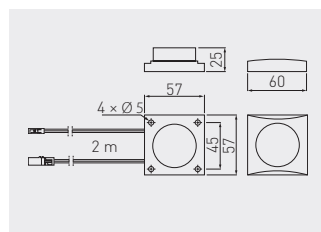

AE-WLKON-20	czarny / black / чёрный	tworzywo plastic / пластмасса



Włącznik łańcuszkowy
Pull chain switch
Выключатель для бра и торшеров с цепочкой

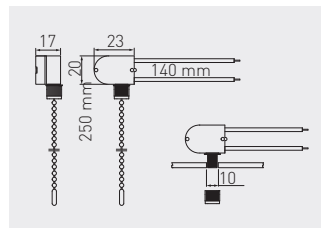

AE-WLLAN1-10

chrom / chrome / хром

tworzywo / plastic / пластик



Kabel zasilający z wtyczką i włącznikiem
Cable with plug & switch
Кабель с вилкой и выключателем

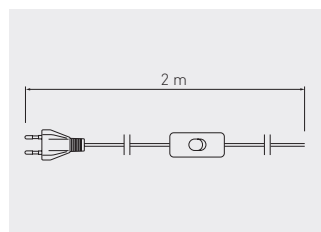

LD-KABE2M-00

biały / white / белый

tworzywo / plastic / пластик



Przewód ze złączkami mini AMP
 Cable with Mini AMP
 Кабель с соединителями мини-AMP

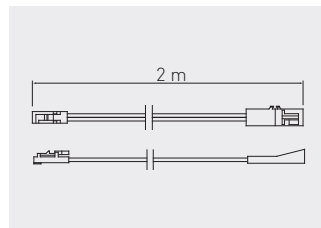

		
LZ-KAPR2M-10	czarny / black / чёрный	tworzywo / plastic / пластик



Złączka do oświetlenia ledowego z dystrybutorem, 3 gniazda
 LED lamp connector with distributor, 3 sockets
 Соединитель LED с распределителем, 3 гнезда

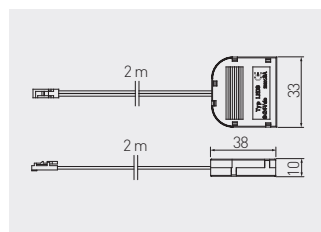

		
LZ-AKZ312-10N	czarny / black / чёрный	tworzywo / plastic / пластик



Złączka do oświetlenia ledowego z dystrybutorem, 6 gniazd
 LED lamp connector with distributor, 6 sockets
 Соединитель LED с распределителем, 6 гнезд

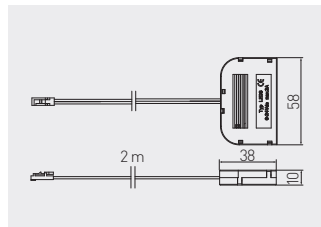

LZ-AKZ612-10N	czarny / black / чёрный	tworzywo / plastic / пластик



Złączka XC11 do taśm LED
 Connector XC11 for LED strips
 Соединитель XC11 для лент LED

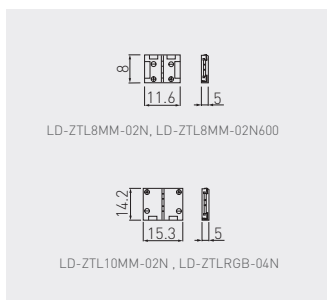

LD-ZTL8MM-02N	8 mm	tworzywo plastic пластик
LD-ZTL8MM-02N600	8 mm / 600 LED	
LD-ZTL10MM-02N	10 mm	
LD-ZTLRGB-04N	RGB	



Złącza XC11 do taśm LED kątowa
 Angular connector XC11 for LED strips
 Угловой соединитель XC11 для лент LED

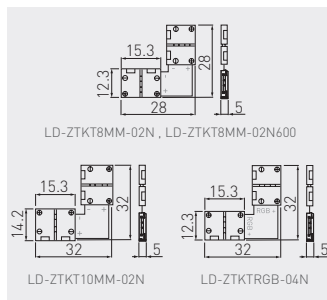



		
LD-ZTKT8MM-02N	8 mm	tworzywo plastic пластик
LD-ZTKT8MM-02N600	8 mm / 600 LED	
LD-ZTKT10MM-02N	10 mm	
LD-ZTKTRGB-04N	RGB	

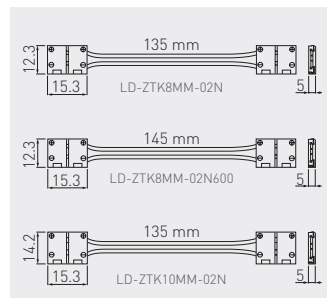

Złącza XC11 do taśm LED z przewodem 15 cm
 Connector XC11 with 15 cm cord, for strips
 Соединитель XC11 для лент LED, с проводом 15 см



		
LD-ZTK8MM-02N	8 mm	tworzywo plastic пластик
LD-ZTK8MM-02N600	8 mm / 600 LED	
LD-ZTK10MM-02N	10 mm	



Złącza XC11 do taśm LED z przewodem 2 m
 Connector XC11 with 2 m cord, for LED strips
 Соединитель XC11 для лент LED, с проводом 2 м



LD-ZTL82M-2N LD-ZTL82M-2N600 LD-ZTL102M-2N LD-ZTLRGB2M-4N

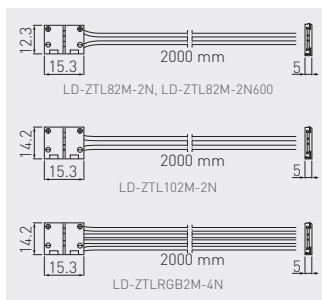

LD-ZTL82M-2N	8 mm	tworzywo plastic пластик
LD-ZTL82M-2N600	8 mm / 600 LED	
LD-ZTL102M-2N	10 mm	
LD-ZTLRGB2M-4N	RGB	



Złącza XC11 do taśm LED z przewodem 2 m i mini amp
 Connector XC11 with 2 m cord and mini AMP, for LED strips
 Соединитель XC11 для лент LED, с проводом 2 м и мини amp

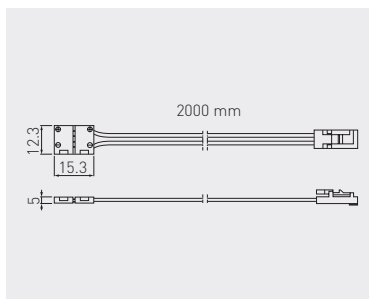

LD-ZTL8MMAMP-02N	8 mm	tworzywo / plastic / пластик
LD-ZTL8MMAMP-02N600	8 mm / 600 LED	



Przedłużacz biurkowy wpuszczany ELITE
 Pull-out power socket ELITE
 Выдвижной настольный удлинитель ELITE

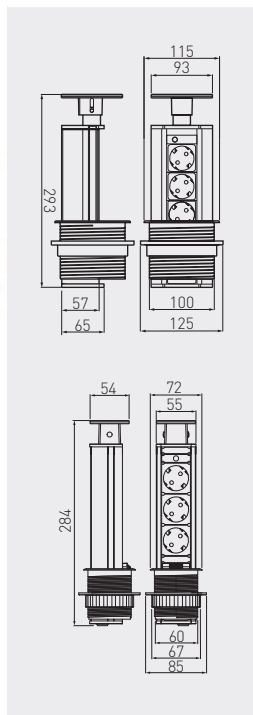

AE-BPWE3GS-00	100	schuko	-	srebrny silver серебристый	aluminium, tworzywo	8
AE-BPWE3GU-00		french	-			
AE-BPWE3S60-00	60	schuko	-		aluminium, plastic алюминий, пластмасса	10
AE-BPWE3S60U-00		5V USB	-			
AE-BPWE3U60-00		french	-			
AE-BPWE3U60U-00		5V USB	-			



Pokrywka i pierścień do przedłużaczy ELITE
 Cap and ring for pull-out power socket ELITE
 Крышка для удлинителя ELITE

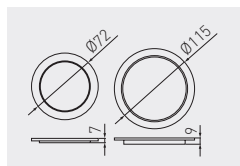

AE-CAP100-40	100	chrom / chrome / хром		stal steel	20
AE-CAP100-51		stal szcztokowana / brushed steel / шлифованная сталь			
AE-CAP60-40	60	chrom / chrome / хром		stal steel	70
AE-CAP60-51		stal szcztokowana / brushed steel / шлифованная сталь			

Przedłużacz biurkowy wpuszczany okrągły \varnothing 60
 Pull-out power socket – round \varnothing 60
 Выдвижной настольный удлинитель, круглый \varnothing 60



AE-BPW3U60-20



AE-BPW3U60-80



AE-BPW3U60U-20



AE-BPW3U60U-80

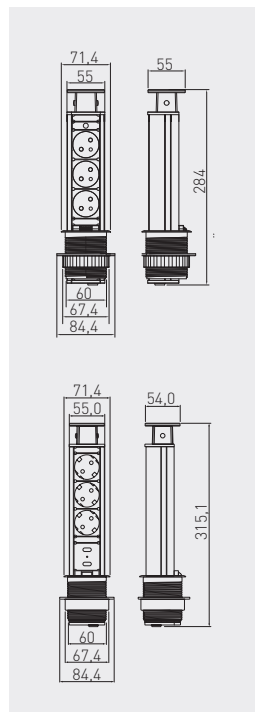

AE-BPW3U60-20	60	french	-	czarny / black / чёрный	aluminium, tworzywo aluminium, plastic алюминий, пластмасса	
AE-BPW3U60-80				srebrny / silver / серебристый		
AE-BPW3S60-20		schuko		czarny / black / чёрный		
AE-BPW3S60-80				srebrny / silver / серебристый		
AE-BPW3U60U-20		french		5V USB		czarny / black / чёрный
AE-BPW3U60U-80						srebrny / silver / серебристый
AE-BPW3S60U-20		schuko				czarny / black / чёрный
AE-BPW3S60U-80						srebrny / silver / серебристый



Przedłużacz biurkowy wpuszczany okrągły \varnothing 100
 Pull-out power socket – round \varnothing 100
 Выдвижной настольный удлинитель, круглый \varnothing 100



AE-BPW3GU-80



AE-BPW3GU-20

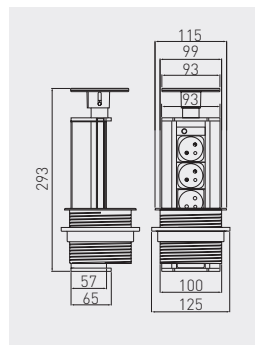

AE-BPW3GU-20	100	french	czarny / black / чёрный	aluminium, tworzywo aluminium, plastic алюминий, пластмасса
AE-BPW3GU-80			srebrny / silver / серебристый	
AE-BPW3GS-20		schuko	czarny / black / чёрный	
AE-BPW3GS-80			srebrny / silver / серебристый	



Przedłużacz biurkowy wpuszczany prostokątny
 Rectangular pop-up power and connection socket
 Настольный удлинитель, прямоугольный, врезной



AE-PB02GS-53



AE-PBC2GU-53

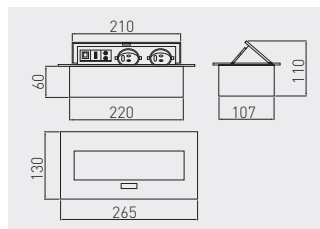

AE-PB02GS-53	schuko	-	aluminium aluminium алюминий	stal, tworzywo steel, plastic сталь, пластмасса
AE-PB02GU-53	french	-		
AE-PBC2GU-53	french	1,5 m		



Przedłużacz biurkowy wpuszczany prostokątny
 Rectangular pop-up power and connection socket
 Настольный удлинитель, прямоугольный, врезной



AE-PB03GS-53	schuko	-	aluminium aluminium алюминий	stal, tworzywo steel, plastic сталь, пластмасса	
AE-PB03GU-53	french	-			
AE-PBC3GU-53	french	1,5 m			
AE-PBC3GU-20	french	1,5 m	czarny / black / чёрный		
AE-PBC3GU-10	french	1,5 m	biały / white / белый		



Przedłużacz biurkowy wpuszczany prostokątny
 Rectangular pop-up power and connection socket
 Настольный удлинитель, прямоугольный, врезной



AE-PBU2GU-10	french	biały / white / белый	stal, tworzywo steel, plastic сталь, пластмасса	
AE-PBU2GU-20	schuko	czarny / black / чёрный		



Przedłużacz biurkowy kątowy
 Corner power socket
 Настольный удлинитель, угловой

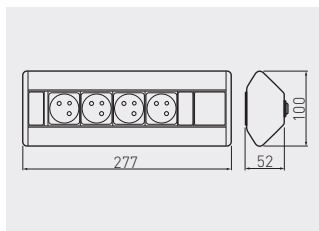

AE-PBKT4U-80	french	-	srebrny silver серебристый	aluminium, tworzywo aluminium, plastic алюминий, пластмасса
AE-PBKT4S-80	schuko			
AE-PBKT3U2U-80	french	5V USB		
AE-PBKT3S2U-80	schuko			



Przedłużacz biurkowy MULTI
 Power socket MULTI
 Настольный удлинитель MULTI

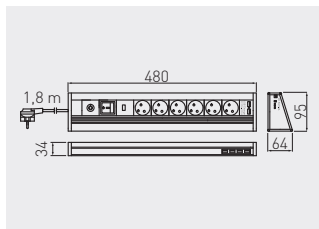

AE-PBMUL6U6U-53	french	aluminium aluminium алюминий	aluminium, tworzywo aluminium, plastic алюминий, пластмасса
AE-PBMUL6S6U-53	schuko		



Przedłużacz biurkowy wpuszczany CHARGER
 Desk recessed power socket CHARGER
 Настольный удлинитель, встраиваемый CHARGER



AE-BPW1S2UCH-80

AE-BPW1U2UCH-80

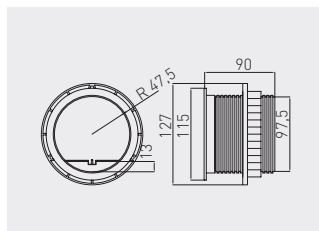

AE-BPW1S2UCH-80	100	schuko	srebrny silver серебристый	tworzywo plastic пластмасса
AE-BPW1U2UCH-80		french		



Przedłużacz biurkowy bez kasety
 Through-desk power socket without housing
 Настольный удлинитель без корпуса



AE-PBC3GS-51BK

AE-PBC3GU-51BK

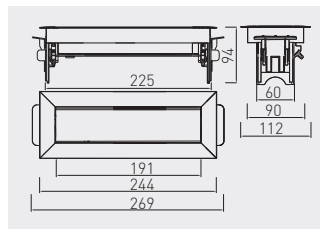

AE-PBC3GS-51BK	schuko	stal szczotkowana brushed steel шлифованная сталь	stal, aluminium, tworzywo steel, aluminium, plastic сталь, алюминий, пластмасса
AE-PBC3GU-51BK	french		



Przedłużacz biurkowy przepustowy z USB
Through-desk power socket letterbox brush cable access with USB
Настольный удлинитель с пропуском под кабель с USB

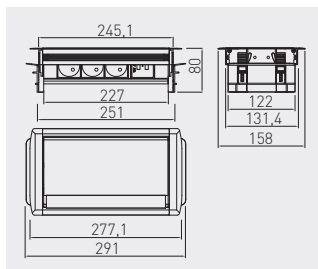

AE-PBC3GS-53BKS	schuko	-	aluminium aluminium алюминий	aluminium, tworzywo aluminium, plastic алюминий, пластмасса
AE-PBC3GU-53BKS	french	-		
AE-PBC3GS2U-53BKS	schuko	USB		
AE-PBC3GU2U-53BKS	french	USB		



Przedłużacz biurkowy przepustowy z HDMI
Through-desk power socket letterbox brush cable access with HDMI port
Настольный удлинитель с пропуском под кабель, с выходом HDMI

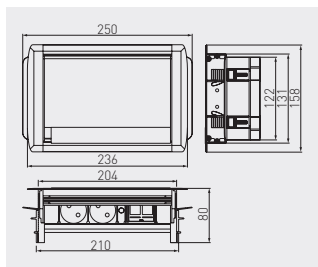

AE-PBC2GS1HDMI-53BKS	schuko	1 x HDMI	aluminium aluminium алюминий	aluminium, tworzywo aluminium, plastic алюминий, пластмасса
AE-PBC2GU1HDMI-53BKS	french			



OBJAŚNIENIA IKON / ICONS EXPLANATION / ОПИСАНИЕ ИКОНОК



indeks
index
индекс



szerokość
width
ширина



dotatkowe informacje
additional information
дополнительная информация



wysokość prowadnika
guide height
высота чашки



wymiary (mm)
dimensions (mm)
размеры (мм)



stopień ochrony IP
protection rating IP
степень защиты IP



wkręty zwykłe
wood screws
саморезы



wymiary (m)
dimensions (m)
размеры (м)



odległość cięcia
cutting distance
длина отрезка



euro wkręty
euro screws
евро саморезы



grubość
thickness
толщина



szerokość taśmy
strip width
ширина ленты



pokrycie
finish
покрытие



szerokość zewnętrzna szafki
outside width of the cabinet
наружная ширина ящика



USB
USB
USB



kolor
color
цвет



materiał
material
материал



rodzaj gniazda
socket type
тип гнезда



obciążenie
load
нагрузка



wysuw
extension
выдвижение



moc
power
номинальный режим



pojemność
capacity
емкостельность



kształt
shape
форма

Aksesoria meblowe
Furniture accessories
Мебельная фурнитура



siła oporu
strenight
сила опоры



strumień świetlny
luminous flux
номинальный световой поток



zawias nakładany
overlay door
накладная петля



długość
length
длина



długość przewodu
wire length
длина провода



zawias bliźniaczy
twin overlay
полунакладная петля



rozstaw
size
межцентровое расстояние



ilość diod
number of diodes
количество диод



zawias wpuszczany
inset door
вкладная петля



wysokość
height
высота



kolor obudowy
housing color
цвет корпуса



zawias kątowy
corner hinge
угловая петля



strata wysuwu
extension loss
потеря выдвижения



temperatura barwowa światła
color temperature
температура оттенка света



zawias o szerokim kącie otwarcia
wide angle hinge
петля с широким углом открывания



średnica
diameter
диаметр



kąt świecenia
beam angle
угол свечения



zawias równoległy
parallel hinge
петля под фальшьпанель (равнолежащая)

	zawias równoległy nakładany parallel hinge for overlay door петля накладная под фальшпанель		SLIDE-ON sposób montażu slide-on slide-on mounting надвижной монтаж slide-on		PUSH push-to-open
	zawias uzupełniający complementary hinge петля для складных дверей		SLOW zawias z mechanizmem cichego domyku hinge with soft closing петля с доводчиком Soft Close		FULL pełny wysuw full extension полное выдвижение
	regulacja adjustment регулировка				szuflada standard standard drawer стандартный ящик
	działanie jednostopniowe single action hinge одношаговая петля		zawias ze sprężyną dociągającą hinge with closing spring петля с прижимной пружиной		szuflada zlewozmywakowa under sink drawer ящик под мойку
	działanie dwustopniowe double action hinge двухшаговая петля		zawias bez sprężyny hinge without spring петля без пружины		szuflada narożna corner drawer ящик угловой
	SPECIAL zawias do zastosowań specjalnych special hinge петля для специальных конструкций		A szuflada niska low drawer низкий ящик		szuflada standardowa standard drawer стандартный ящик
	∅ 35 mm średnica puszki hinge cup diameter диаметр чашки		B szuflada średnia medium drawer средний ящик		szuflada wewnętrzna inner drawer внутренний ящик
	45 mm rozstaw otworów puszek hinge cup drilling spacing межцентровое расстояние отверстий на чашке		C szuflada wysoka high drawer высокий ящик		przewodnica dolnego montażu under mount drawer направляющая нижнего монтажа
	montaż puszek na wkręty do drewna wood screw hinge cup mounting монтаж чашки на саморезы по дереву		regulacja pion i poziom vertical and horizontal adjustment регулировка по ширине и высоте		przewodnica kulkowa ball-bearing slide шариковая направляющая
	montaż prowadnika na wkręty do drewna wood screw mounting plate installation установка ответной планки на саморезы по дереву		opcja wypięcia release option снятие ящика без инструментов		przewodnica rolkowa roller slide роликовая направляющая
	montaż prowadnika na wkręty euro euro screw mounting plate installation установка ответной планки на евровинты		H=83 wysokość boku MB Square drawer side height MB Square высота боковой стенки MB Square		metalbox metalbox металбок
	montaż prowadnika na kolki dowel mount hinge монтаж чашки на саморезы с дюбелями		H=83 wysokość boku MB drawer side height MB высота боковой стенки MB		SLOW cichy domyk quiet shut бесшумное закрыwanie
	regulacja mimośrodowa eccentric adjustment эксцентриковая регулировка		H=95 wysokość boku AXIS drawer side height AXIS высота боковой стенки AXIS		SELF CLOSING samodociąg self closing доводчик
	x 100 pakowanie packing упаковка		3D dostępna bryła 3D 3D model available есть 3D модель		montaż nasuwany ze sprzęgłem push mounting with locking device надвижной монтаж с креплением фасада
	CLIP-ON sposób montażu clip-on clip-on mounting быстрый монтаж clip-on		CERTIFICATE 60.000 trwałość tested durability кол-во циклов откр./закрыт.		montaż nakładany put on mounting накладной монтаж



Oświetlenie meblowe Furniture lighting Мебельное освещение

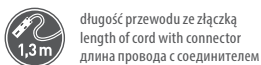
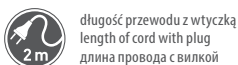
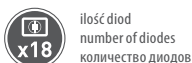
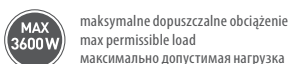
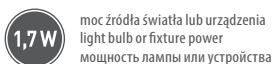
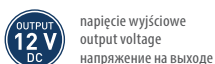
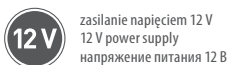
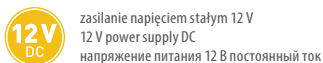
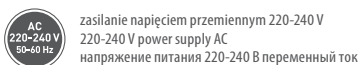
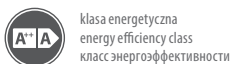

	długość przewodu z wtyczką length of cord with plug длина провода с вилкой		czas pracy nominal lifetime время работы
	długość przewodu ze złączką length of cord with connector длина провода с соединителем		czas włączania starting time (max) время включения
	rodzaj złączki type of connector тип соединителя		trzonek źródła światła G4 base type G4 тип цоколя G4
	rodzaj złączki type of connector тип соединителя		temperatura pracy working temperature рабочая температура
	rodzaj złączki type of connector тип соединителя		gniazdo USB USB port USB – порт
	stopień ochrony IP international protection marking пылевлагозащита IP		maksymalne obciążenie gniazd USB max load USB ports максимальная нагрузка портов USB
	współczynnik oddawania barw colour rendering index индекс цветопередачи		gniazdo UK UK socket гнездо UK
	współczynnik mocy power factor коэффициент мощности		ethernet ethernet port ethernet – порт
	liczb cykli wł./wyl. switching cycle количество циклов вкл./выкл.		nie współpracuje ze ściemniaczami non-dimmable нет возможности подключения диммера
	włącznik dotykowy ściemniający dimnable touch switch выключатель с регулятором яркости		współpracuje ze ściemniaczami dimmable есть возможность подключения диммера
	oprawa z włącznikiem fixture with switch светильник с выключателем		montaż na ścianie / suficie application: indoor / ceiling mounted монтаж на стене / потолке
	sterowanie pilotem IR remote control IR управление с помощью пульта ИК		rekomendowana odległość montażu od powierzchni recommended mounting distance from surfaces рекомендуется монтаж устройства на расстоянии
	włącznik bezdotykowy dwubiegowy two-pole touchless switch бесконтактный переключатель / двухфункциональный		średnica otworu montażowego mounting hole diameter монтажное отверстие диаметром
	włącznik do szafy / jednobiegowy single-pole touchless switch переключатель для шкафов / однофункциональный		akumulator battery аккумулятор
	zasięg czujki ruchu range of motion sensor площадь действия сенсора		

KOLORY
COLORS
ЦВЕТА



10
biały
white
белый



80
srebrny
silver
серебристый



20
czarny
black
чёрный



10M
biały mat
white matt
белый матовый



7
antyczne srebro
antique silver
античное серебро



20M
czarny mat
black matt
чёрный матовый



mleczny
milk
молочный



2, 52
satyna
satin
сатин



58
wenge
wenge
венге



CS
kremowy
ecru
экрю



6, 51
stal szczotkowana
brushed steel
шлифованная сталь



3
mosiądz
brass
латунь



1, 40
chrom
chrome
хром



11
tytan szczotkowany
brushed titanium
шлифованный титан



4
antyczny mosiądz
antique brass
античная латунь



5, 53
aluminium
aluminium
алюминий



12
czarny chrom
black chrome
чёрный хром



9
antyczny mosiądz
szczotkowany
antique brushed brass
античная шлифованная латунь



30
szary
gray
серый



13
tytan
titanium
титан



22
kość słoniowa
ivory
слоновая кость



ocynk
zink – plated
оцинковка



14
antyczna miedź
antique cooper
античная медь



50
beż
beige
кремовый



44
buk
beech
бук



61
ciemny mahoń
dark mahogany
темное красное дерево



41
olcha
alder
ольха



20, 48, 731
mahoń
mahogany
красное дерево



43
jasny brąz
light brown
светло-коричневый



NB
niebieski
blue
синий



51
calvados
calvados
кальвадос



ZL
zielony
green
зеленый



52
wiśnia
cherry
вишня



RZ
różowy
pink
розовый



42
grusza
pear
груша



PM
pomarańczowy
orange
оранжевый



30
brąz
brown
коричневый



7, 31, 732
ciemny brąz
dark brown
темно-коричневый

Klasa ochronności na pył, ciała stałe i wodę
Dust, solids & water ingress protection rating
Класс защиты от пыли, твердых тел и воды

IP	Stopień ochrony I Protection rating I Степень защиты I
0	Brak ochrony None Отсутствие защиты
1	Ochrona przed ciałami obcymi stałymi o wielkości ponad 50 mm. Protection against ingress of > 50 mm bodies. Защита от попадания инородных твердых тел размером более 50 мм.
2	Ochrona przed ciałami stałymi przekraczającymi 12 mm. Protection against ingress of > 12 mm bodies. Защита от попадания инородных твердых тел размером более 12 мм.
3	Ochrona przed ciałami stałymi przekraczającymi 2,5 mm. Protection against ingress of > 2.5 mm bodies. Защита от попадания инородных твердых тел размером более 2,5 мм.
4	Ochrona przed ciałami stałymi przekraczającymi 1 mm. Protection against ingress of > 1 mm bodies. Защита от попадания инородных твердых тел размером более 1 мм.
5	Pyłoodporność Protection against ingress of dust Пылестойкость
6	Pyłoszczelność Dustproof Пылестойкость

IP	Stopień ochrony II Protection rating II Степень защиты II
0	Brak ochrony None Отсутствие защиты
1	Ochrona przed pionowo wpadającymi kroplami wody. Protection against dripping water (vertically falling drops). Защита от вертикально падающих капель воды.
2	Ochrona przed kroplami wody przy przechyleniu do 15°. Protection against dripping water when tilted up to 15°. Защита от капель воды, падающих под углом до 15°.
3	Ochrona przed rozpyloną wodą Protection against spraying water. Защита от распыленной воды.
4	Ochrona przed bryzgami wody Protection against splashing of water. Защита от брызг воды.
5	Ochrona przed strugami wody Protection against water jets Защита от струй воды
6	Ochrona przed falami Protection against powerful water jets (waves) Защита от волн
7	Ochrona przed zanurzeniem Protection against immersion Защита от погружения
8	Ochrona przed głębokim zanurzeniem Protection against deep immersion Защита от глубокого погружения

Klasa ochronności przed porażeniem elektrycznym

Electric shock protection class

Класс защиты от поражения электрическим током

Klasa bezpieczeństwa Safety class Класс безопасности	Symbol Symbol Символ	Wyjaśnienie Definition Пояснение
0	Brak None Нет Keine Nincs	<p>Ochronę przed porażeniem elektrycznym stanowi izolacja podstawowa. W przypadku uszkodzenia izolacji ochronę przeciwporażeniową powinny zapewnić odpowiednio korzystne warunki środowiskowe oraz położenie urządzenia poza dotykem bezpośrednim.</p> <p>The protection against electric shock relies on basic insulation only. In the event of insulation failure, electric shock protection shall be assured by suitably favourable environmental conditions and locating the equipment beyond the reach of direct touch.</p> <p>Защиту от поражения электрическим током обеспечивает основная изоляция. В случае повреждения изоляции защиту от поражения электрическим током должны обеспечить соответствующие благоприятные условия окружающей среды и размещение оборудования вне зоны прямого контакта.</p>
I		<p>W urządzeniach z I klasą ochronności bezpieczeństwo zapewnione jest przez połączenie wszystkich czynnych przewodzących elementów z przewodem ochronnym lub bezpośrednio z uziemieniem.</p> <p>Class I equipment provides protection by connecting all live conductive parts to a protective wire or directly to earth.</p> <p>В устройствах с I классом защиты безопасность обеспечивается посредством объединения всех действующих проводящих элементов с защитным проводом или непосредственно с заземлением.</p>
II		<p>W urządzeniach z II klasą ochronności bezpieczeństwo zapewnione jest przez zastosowanie izolacji podwójnej lub wzmocnionej, której w danych warunkach środowiskowych i przy napięciu znamionowym uważa się nie do przebicia.</p> <p>Class II equipment provides protection by the use of double or strengthened insulation, which is deemed breakdown-proof under given environmental conditions at the rated voltage.</p> <p>В устройствах с II классом защиты безопасность обеспечивается путем применения двойной или усиленной изоляции, которая в данных условиях окружающей среды и при номинальном напряжении считается непробиваемой.</p>
III		<p>Ochrona przeciwporażeniowa w urządzeniach z III klasy ochronności jest zapewniona przez obniżenie napięcia zasilania do wartości bezpiecznej w danych warunkach środowiskowych.</p> <p>Class III equipment protection against electric shock is provided by reduction of power voltage to a safe limit under given environmental conditions.</p> <p>Защита от поражения электрическим током в устройствах с III классом защиты обеспечивается снижением напряжения питания до безопасного в данных условиях окружающей среды значения.</p>

Indeksy

A-B63-32.....	418
A-B63-40.....	418
A-BUDP-SET.....	424
A-BUD-UB.....	424
A-BUD-UG.....	424
A-BUD-UM.....	424
A-BUD-UR.....	424
A-C18-300-05.....	408
A-C18-300-05.....	421
A-C18-300-05.....	422
A-C18-300-10.....	408
A-C18-300-20M.....	408
A-C18-300-90.....	408
A-DPG-16.....	412
AE-BPW1S2UCH-80.....	496
AE-BPW1U2UCH-80.....	496
AE-BPW3GS-20.....	493
AE-BPW3GS-80.....	493
AE-BPW3GU-20.....	493
AE-BPW3GU-80.....	493
AE-BPW3S60-20.....	492
AE-BPW3S60-80.....	492
AE-BPW3S60U-20.....	492
AE-BPW3S60U-80.....	492
AE-BPW3U60-20.....	492
AE-BPW3U60-80.....	492
AE-BPW3U60U-20.....	492
AE-BPW3U60U-80.....	492
AE-BPWE3GS-00.....	491
AE-BPWE3GU-00.....	491
AE-BPWE3S60-00.....	491
AE-BPWE3S60U-00.....	491
AE-BPWE3U60-00.....	491
AE-BPWE3U60U-00.....	491
AE-CAP60-40.....	491
AE-CAP60-51.....	491
AE-CAP100-40.....	491
AE-CAP100-51.....	491
AE-PB02GS-53.....	493
AE-PB02GU-53.....	493
AE-PB03GS-53.....	494
AE-PB03GU-53.....	494
AE-PBC2GS1HDMI-53BKS.....	497
AE-PBC2GU1HDMI-53BKS.....	497
AE-PBC2GU-53.....	493
AE-PBC3GS2U-53BKS.....	497
AE-PBC3GS-51BK.....	496
AE-PBC3GS-53BKS.....	497
AE-PBC3GU2U-53BKS.....	497
AE-PBC3GU-10.....	494
AE-PBC3GU-20.....	494
AE-PBC3GU-51BK.....	496
AE-PBC3GU-53.....	494
AE-PBC3GU-53BKS.....	497
AE-PBKT3S2U-80.....	495
AE-PBKT3U2U-80.....	495
AE-PBKT4S-80.....	495
AE-PBKT4U-80.....	495
AE-PBMUL6S6U-53.....	495
AE-PBMUL6U6U-53.....	495
AE-PBU2GU-10.....	494
AE-PBU2GU-20.....	494
AE-USBCH-20.....	479
AE-WBBUNI-10DIM.....	482
AE-WBCUNI-10DIM.....	482
AE-WBEZDB-10S.....	480
AE-WBEZDC-10S.....	480
AE-WBEZDK15-10.....	481
AE-WBEZD-NB.....	483
AE-WBEZDPIR2-20.....	482
AE-WBEZDPIR-10.....	481
AE-WDSB-10DIM.....	483
AE-WDSC-10DIM.....	483
AE-WLB01-10.....	485
AE-WLC01-20.....	485
AE-WLKON-20.....	485
AE-WLLAN1-10.....	486

AE-WLPR-60.....	484
AE-WLPR-60P2.....	484
AE-WPDRW-00.....	484
AE-ZLADPOD-20.....	480
AE-ZUSB-20.....	479
A-H16-300-05.....	408
A-H16-300-90.....	408
A-H18-300-05.....	409
A-H18-300-10.....	409
A-H18-300-20M.....	409
A-H18-300-90.....	409
A-HR10FL-300-05.....	410
A-HR10FL-300-10.....	410
A-HR10FL-300-90.....	410
A-HR18-300-05.....	409
A-HR18-300-10.....	409
A-HR18-300-20M.....	409
A-HR18-300-90.....	409
A-HR19-300-05.....	409
A-HRS10-170-05.....	410
A-HRS10-300-05.....	410
A-HRS10-300-90.....	410
A-HRS10-405-05.....	410
A-HRS10-600-05.....	410
A-K18-300-05.....	407
A-K18-300-10.....	407
A-K18-300-20M.....	407
A-K18-300-90.....	407
A-KLP-4.....	416
A-KR-4.....	416
A-LD10-170-05.....	406
A-LD10-235-05.....	406
A-LD10-235-90.....	406
A-LD10-300-05.....	406
A-LD10-300-10.....	406
A-LD10-300-90.....	406
A-LD10-405-05.....	406
A-LD10-405-90.....	406
A-LD10-600-05.....	406
A-LD10-600-90.....	406
A-LD10FL-235-05.....	407
A-LD10FL-235-90.....	407
A-LD10FL-300-05.....	407
A-LD10FL-300-10.....	407
A-LD10FL-300-90.....	407
A-LD18-170-05.....	404
A-LD18-170-90.....	404
A-LD18-235-05.....	404
A-LD18-235-90.....	404
A-LD18-300-05.....	404
A-LD18-300-10.....	404
A-LD18-300-20M.....	404
A-LD18-300-90.....	404
A-LD18-405-05.....	404
A-LD18-405-90.....	404
A-LD18-600-90.....	404
A-LD19-300-05.....	405
A-LG10-170-05.....	405
A-LG10-235-05.....	405
A-LG10-235-90.....	405
A-LG10-300-05.....	405
A-LG10-300-10.....	405
A-LG10-300-90.....	405
A-LG10-405-05.....	405
A-LG10-405-90.....	405
A-LG10-600-05.....	405
A-LG10-600-90.....	405
A-LG10FL-235-05.....	406
A-LG10FL-235-90.....	406
A-LG10FL-300-05.....	406
A-LG10FL-300-10.....	406
A-LG10FL-300-90.....	406
A-LG18-170-05.....	403
A-LG18-170-90.....	403
A-LG18-235-05.....	403
A-LG18-235-90.....	403
A-LG18-300-05.....	403
A-LG18-300-10.....	403
A-LG18-300-20M.....	403

A-LG18-300-90.....	403
A-LG18-405-05.....	403
A-LG18-405-90.....	403
A-LG18-600-90.....	403
A-LG19-300-05.....	404
AM-ADAPOA-10.....	42
AM-ADAPOA-60.....	42
AM-ADAPOB-10.....	42
AM-ADAP0B-60.....	42
AM-BOCZ01-60.....	40
A-MEVO-170-05.....	401
A-MEVO-170-90.....	401
A-MEVO-235-05.....	401
A-MEVO-235-90.....	401
A-MEVO-300-05.....	401
A-MEVO-300-10A.....	401
A-MEVO-300-20M.....	401
A-MEVO-300-90.....	401
A-MEVO-405-05.....	401
A-MEVO-405-10.....	401
A-MEVO-405-90.....	401
A-MITO-PLUS.....	420
AM-KRZYZ-KPL.....	47
AM-MBSOFT-P2.....	87
AM-OAD-DL-GM.....	43
AM-OAD-DL-MG.....	43
AM-OAD-KR-GM.....	43
AM-OAD-KR-MG.....	43
AM-OADS-DL-GM.....	43
AM-OADS-DL-MG.....	43
AM-OADS-KR-GM.....	43
AM-ODB000-10.....	41
AM-ODB000-60.....	41
AM-ODB01S-60.....	41
AM-OWP-DL-GM.....	44
AM-OWP-DL-MG.....	44
AM-OWP-KR-GM.....	44
AM-OWP-KR-MG.....	44
AM-OWPS-DL-GM.....	44
AM-OWPS-DL-MG.....	44
AM-OWPS-KR-GM.....	44
AM-OWPS-KR-MG.....	44
AM-PLA-DLU-0.....	43
AM-PL-DL-MAG.....	43
A-MPRO-170-05.....	403
A-MPRO-170-90.....	403
A-MPRO-235-05.....	403
A-MPRO-235-90.....	403
A-MPRO-300-05.....	403
A-MPRO-300-10.....	403
A-MPRO-300-90.....	403
A-MPRO-405-05.....	403
A-MPRO-405-90.....	403
AM-PROST-KPL.....	40
AMR-BP-0715.....	45
AMR-BP-1003.....	45
AMS-MPST001-OC.....	371
AMS-MPST002-OC.....	371
AMS-MPST003-OC.....	372
A-MSOFT-ADAPT.....	419
A-MSOFT-RAMA.....	419
AM-ZAT-A1-10.....	44
A-PG-18.....	410
A-PGR-10.....	411
A-PGR-10S.....	411
A-PGR-18.....	411
A-POZ-MITO.....	420
A-PTD.....	414
A-PTG.....	413
A-PW-RC-DOC.....	419
A-R10ARCO-270-05.....	399
A-R10ARCO-270-90.....	399
A-R10FALDA-270-05.....	399
A-R10FALDA-270-90.....	399
A-R10FL-270-05.....	397
A-R10FL-270-10.....	397
A-R10FL-270-90.....	397
A-R10FORM-270-05.....	398
A-R10FORM-270-90.....	398

A-R10NOV-270-05.....	398	A-TDEVO-300-10.....	401	GZ-CRPA20-A1.....	324
A-R10NOV-270-10.....	398	A-TDEVO-300-20M.....	401	GZ-CRPA25-01.....	324
A-R10NOV-270-90.....	398	A-TDEVO-300-90.....	401	GZ-CRPA25-03.....	324
A-R10TORO-270-05.....	399	A-TDEVO-405-05.....	401	GZ-CRPA25-A1.....	324
A-R10TORO-270-90.....	399	A-TDEVO-405-10.....	401	GZ-CRPA30-01.....	324
A-R10TRAF0-270-05.....	398	A-TDEVO-405-90.....	401	GZ-CRPA30-03.....	324
A-R10TRAF0-270-90.....	398	A-TDEVO-600-05.....	401	GZ-CRPA30-A1.....	324
A-R16ERG-270-50.....	394	A-TDEVO-600-90.....	401	GZ-CRPA40-01.....	324
A-R18CARO-270-05.....	395	A-TDPRO-170-05.....	402	GZ-CRPA40-03.....	324
A-R18CARO-270-90.....	395	A-TDPRO-170-90.....	402	GZ-CRPA40-A1.....	324
A-R18COTE-270-05.....	397	A-TDPRO-235-05.....	402	GZ-CRBP20-01.....	324
A-R18COTE-270-90.....	397	A-TDPRO-235-90.....	402	GZ-CRBP20-03.....	324
A-R18ERG-270-05.....	394	A-TDPRO-300-05.....	402	GZ-CRBP20-A1.....	324
A-R18ERG-270-90.....	394	A-TDPRO-300-10.....	402	GZ-CRBP25-01.....	324
A-R18GEO-270-05.....	400	A-TDPRO-300-90.....	402	GZ-CRBP25-03.....	324
A-R18LOCA-305-05.....	397	A-TDPRO-405-05.....	402	GZ-CRBP25-A1.....	324
A-R18LOCA-305-90.....	397	A-TDPRO-405-90.....	402	GZ-CRBP30-01.....	324
A-R18NERO-270-05.....	396	A-TDPRO-600-05.....	402	GZ-CRBP30-03.....	324
A-R18NERO-270-10.....	396	A-TDPRO-600-90.....	402	GZ-CRBP30-A1.....	324
A-R18NERO-270-20M.....	396	A-TG-170-05.....	400	GZ-CRBP40-01.....	324
A-R18NERO-270-90.....	396	A-TG-170-90.....	400	GZ-CRBP40-03.....	324
A-R18NOVS-270-05.....	395	A-TG-235-05.....	400	GZ-CRBP40-A1.....	324
A-R18NOVS-270-10.....	395	A-TG-235-90.....	400	GZ-CRPC30-01.....	325
A-R18NOVS-270-20M.....	395	A-TG-300-05.....	400	GZ-CRPC30-A1.....	325
A-R18NOVS-270-90.....	395	A-TG-300-10.....	400	GZ-CRPC40-01.....	325
A-R18VIS-270-05.....	396	A-TG-300-20M.....	400	GZ-CRPC40-A1.....	325
A-R18VIS-270-90.....	396	A-TG-300-90.....	400	GZ-FROSI-1-04.....	317
A-R19NERO-300-05.....	396	A-TG-405-05.....	400	GZ-FROSI-1-09.....	317
A-R19NOVS-300-05.....	395	A-TG-405-10.....	400	GZ-GANZA-1-01.....	245
A-RD-MITO.....	420	A-TG-405-90.....	400	GZ-GANZA-1-05.....	245
A-RNOV2-270-05.....	394	A-TG-600-05.....	400	GZ-GANZA-1-10.....	245
A-RNOV2-270-10.....	394	A-TG-600-90.....	400	GZ-GANZA-1-12.....	245
A-RNOV2-270-90.....	394	A-TG-BUD-200-00.....	424	GZ-HILL-1-01.....	246
A-SG-MITO.....	420	A-TG-BUD-300-00.....	424	GZ-HILL-1-05.....	246
A-SN-ADSET.....	421	A-TMITO-200-05.....	420	GZ-HILL-1-06.....	246
A-SN-ADSET.....	422	A-TMITO-250-00.....	420	GZ-HILL-1-12.....	246
A-SN-FSET.....	421	A-TMITO-250-05.....	420	GZ-IMOLA-1-01.....	256
A-SN-HSET1.....	422	A-TMITO-300-05.....	420	GZ-IMOLA-1-02.....	256
A-SN-K19-270-05.....	421	A-USZCZ-CH4.....	416	GZ-IMOLA-1-05.....	256
A-SN-K19-270-05.....	422	A-USZCZ-CHM4.....	417	GZ-IMOLA-1-06.....	256
A-SN-POZ.....	422	A-USZCZ-TDEVO2.....	417	GZ-OLBIA-1-04.....	310
A-SN-R19RIV-270-05.....	421	A-USZCZ-U4.....	417	GZ-OLIVA-16-01.....	248
A-SN-R19RIV-270-05.....	422	A-WD-EVO.....	412	GZ-PALER-1-07.....	302
A-SN-SDP-TU.....	423	A-WD-PRO.....	412	GZ-ROMA-1-01.....	256
A-SN-SOFT-25.....	421	A-WDR-EVO.....	413	GZ-ROMA-1-02.....	256
A-SN-SOFT-25.....	422	A-WDR-PRO.....	413	GZ-ROMA-1-05.....	256
A-SN-SOFT-40.....	421	A-ZAT-TDEVO2.....	416	GZ-ROMA-1-06.....	256
A-SN-SOFT-40.....	422	BP-SLZIGW-10.....	363	GZ-ROYAL3-1-10/03.....	313
A-SN-TDS-405-00.....	421	BP-SLZIGW-21.....	364	GZ-SENIOR-1-01.....	244
A-SN-TDT-405-00.....	422	EM-SBL060-01.....	154	GZ-SENIOR-1-05.....	244
A-SN-TG-405-00.....	421	EM-SBL100-01.....	154	GZ-TERNI-1-01.....	286
A-SN-TG-405-00.....	422	EM-SBL150-01.....	154	GZ-TERNI-1-02.....	286
A-SO-48X4.....	414	GA-IMPER-1-02B.....	318	GZ-TERNI-1-05.....	286
A-SO-145X4.....	414	GA-IMPER-1-11.....	318	GZ-TERNI-1-06.....	286
A-SO-145X4-10.....	414	GA-IMPER-1-20M.....	318	GZ-TERNI-1-09.....	286
A-SO-145X4-20.....	414	GP-0728-J4-A-04.....	300	GZ-TERNI-1-10.....	286
A-SOFT-30.....	418	GP-0728-J4-A-07.....	300	GZ-TERNI-1-12.....	286
A-SOFT-50.....	418	GP-0728-J4-B.....	300	GZ-TERNI-1-20M.....	286
A-SP-7X12.....	415	GP-0728-J4-C-04.....	300	GZ-UDINE-1-01.....	285
A-SP-48X7.....	415	GP-0728-J4-R.....	300	GZ-UDINE-1-02.....	285
A-SP-48X12.....	415	GS-BERGA-1-01.....	285	GZ-UDINE-1-05.....	285
A-T18-300-05.....	408	GS-BERGA-1-02.....	285	GZ-UDINE-1-06.....	285
A-T18-300-10.....	408	GS-BERGA-1-05.....	285	GZ-UDINE-1-10M.....	285
A-T18-300-90.....	408	GS-BERGA-1-06.....	285	GZ-UDINE-1-12.....	285
A-TDEVO2-170-05.....	402	GS-BERGA-1-10.....	285	GZ-UDINE-1-20M.....	285
A-TDEVO2-170-90.....	402	GS-BERGA-1-12.....	285	GZ-VETA-1-01.....	245
A-TDEVO2-235-05.....	402	GS-BERGA-1-20M.....	285	GZ-VETA-1-05.....	245
A-TDEVO2-235-90.....	402	GZ-71C024-01.....	319	GZ-VETA-1-12.....	245
A-TDEVO2-300-05.....	402	GZ-ARDEA-1-04.....	305	GZ-WP1136-04.....	314
A-TDEVO2-300-90.....	402	GZ-CAD032-01.....	249	GZ-WP1148-04.....	315
A-TDEVO2-405-05.....	402	GZ-CENTO-1-04.....	317	GZ-WP1152-04.....	315
A-TDEVO2-405-90.....	402	GZ-CENTO-1-07.....	317	GZ-WP1155-01.....	286
A-TDEVO2-600-05.....	402	GZ-CENTO-1-14.....	317	GZ-ZH-011-01A.....	288
A-TDEVO2-600-90.....	402	GZ-CENTO-1-20M.....	317	GZ-ZH-011-06A.....	288
A-TDEVO-170-05.....	401	GZ-CLEO-1-01.....	244	HB-USB-4X-20.....	234
A-TDEVO-170-90.....	401	GZ-CLEO-1-05.....	244	HB-USB-4X-60.....	234
A-TDEVO-235-05.....	401	GZ-CLEO-1-06.....	244	KK-D50-80-06.....	239
A-TDEVO-235-90.....	401	GZ-CRPA20-01.....	324	KK-D50100-06.....	239
A-TDEVO-300-05.....	401	GZ-CRPA20-03.....	324	KK-W60800-M0.....	240

KK-W60800-M1.....240
 KK-W80800-D0.....240
 KK-W80800-D1.....240
 KM-00-40-D20.....379
 KM-00-50-D20.....379
 KM-0H-40-D20.....379
 KM-0H-50-D20.....379
 KM-015030-10.....379
 KM-015030-20.....379
 KM-015038-10.....379
 KM-015038-GM.....380
 KM-A035MM-00.....380
 KM-A035MM-30.....380
 KM-A050MM-00.....381
 KM-A050MM-30.....381
 KM-AH35MM-00.....380
 KM-AH35MM-30.....380
 KM-AH50MM-00.....381
 KM-AH50MM-30.....381
 KM-B050MM-00.....381
 KM-B050MM-30.....381
 KM-B075MM-00.....382
 KM-B075MM-30.....382
 KM-BH50MM-00.....381
 KM-BH50MM-30.....381
 KM-BH75MM-00.....382
 KM-BH75MM-30.....382
 KM-RD-35-CF.....382
 KM-RD-35-CF-20.....382
 KM-RD-35-SF.....382
 KM-RD-35-SF-20.....382
 KM-RD-50-CF.....383
 KM-RD-50-CF-20.....383
 KM-RD-50-SF.....383
 KM-RD-50-SF-20.....383
 KM-RD-75-CF.....383
 KM-RD-75-CF-20.....383
 KM-RD-75-SF.....383
 KM-RD-75-SF-20.....383
 KO-1502B0-10.....221
 KO-1502B0-CR.....221
 KO-1502B0-SR.....221
 KO-1502MD-CR.....222
 KO-1502MD-SR.....222
 KO-2002B0-10.....221
 KO-2002B0-CR.....221
 KO-2002B0-SR.....221
 KO-2002MD-CR.....222
 KO-2002MD-SR.....222
 KO-3002B0-10.....221
 KO-3002B0-CR.....221
 KO-3002B0-SR.....221
 KO-3002MD-CR.....222
 KO-3002MD-SR.....222
 KO-4002MD-CR.....222
 KO-4002MD-SR.....222
 KO-5002MD-CR.....222
 KO-5002MD-SR.....222
 KO-6002MD-CR.....222
 KO-6002MD-SR.....222
 KO-CMB150-PW-01.....223
 KO-CMB150-PW-10.....223
 KO-CMB150-PW-OC.....223
 KO-CMB200-PW-01.....223
 KO-CMB200-PW-10.....223
 KO-CMB200-PW-OC.....223
 KO-CMB300-PW-01.....223
 KO-CMB300-PW-10.....223
 KO-CMB300-PW-OC.....223
 KO-SRH4550-30-10.....192
 KO-SRH4550-30-OC.....192
 KO-SRH4550-40-10.....192
 KO-SRH4550-40-OC.....192
 KO-SRH4550-50-10.....192
 KO-SRH4550-50-OC.....192
 KO-SRH4550-60-10.....192
 KO-SRH4550-60-OC.....192
 KO-SRH35100-30-10.....191
 KO-SRH35100-30-OC.....191

KO-SRH35100-40-10.....191
 KO-SRH35100-40-OC.....191
 KO-SRH35100-50-10.....191
 KO-SRH35100-50-OC.....191
 KO-SRH35100-60-10.....191
 KO-SRH35100-60-OC.....191
 KO-SRH35150-30-10.....191
 KO-SRH35150-30-OC.....191
 KO-SRH35150-40-10.....191
 KO-SRH35150-40-OC.....191
 KO-SRH35150-50-10.....191
 KO-SRH35150-50-OC.....191
 KO-SRH35150-60-10.....191
 KO-SRH35150-60-OC.....191
 KO-SRH35200-30-10.....191
 KO-SRH35200-30-OC.....191
 KO-SRH35200-40-10.....191
 KO-SRH35200-40-OC.....191
 KO-SRH35200-50-10.....191
 KO-SRH35200-50-OC.....191
 KO-SRH35200-60-10.....191
 KO-SRH35200-60-OC.....191
 KO-SRH45100-30-10.....192
 KO-SRH45100-30-OC.....192
 KO-SRH45100-40-10.....192
 KO-SRH45100-40-OC.....192
 KO-SRH45100-50-10.....192
 KO-SRH45100-50-OC.....192
 KO-SRH45100-60-10.....192
 KO-SRH45100-60-OC.....192
 KO-SRH45150-30-10.....192
 KO-SRH45150-30-OC.....192
 KO-SRH45150-40-10.....192
 KO-SRH45150-40-OC.....192
 KO-SRH45150-50-10.....192
 KO-SRH45150-50-OC.....192
 KO-SRH45150-60-10.....192
 KO-SRH45150-60-OC.....192
 KO-SRH45200-30-10.....192
 KO-SRH45200-30-OC.....192
 KO-SRH45200-40-10.....192
 KO-SRH45200-40-OC.....192
 KO-SRH45200-50-10.....192
 KO-SRH45200-50-OC.....192
 KO-SRH45200-60-10.....192
 KO-SRH45200-60-OC.....192
 KO-SRPR100-30-10.....193
 KO-SRPR100-30-OC.....193
 KO-SRPR100-40-10.....193
 KO-SRPR100-40-OC.....193
 KO-SRPR100-50-10.....193
 KO-SRPR100-50-OC.....193
 KO-SRPR100-60-10.....193
 KO-SRPR100-60-OC.....193
 KO-SRPR150-30-10.....193
 KO-SRPR150-30-OC.....193
 KO-SRPR150-40-10.....193
 KO-SRPR150-40-OC.....193
 KO-SRPR150-50-10.....193
 KO-SRPR150-50-OC.....193
 KO-SRPR150-60-10.....193
 KO-SRPR150-60-OC.....193
 KO-SRPR200-30-10.....193
 KO-SRPR200-30-OC.....193
 KO-SRPR200-40-10.....193
 KO-SRPR200-40-OC.....193
 KO-SRPR200-50-10.....193
 KO-SRPR200-50-OC.....193
 KO-SRPR200-60-10.....193
 KO-SRPR200-60-OC.....193
 KO-UMC4645C.....220
 KO-UMC4845C.....220
 KT-APRIL-1-04.....306
 KT-WP1147-04.....316
 KW-FS0125-01.....146
 KW-FS0140-01.....146
 KW-FS0335-01.....146
 KW-FS0350-01.....146
 KW-FS0375-01.....146

KW-FS0425-03.....147
 KW-FS0430-03.....147
 KW-FS0440-03.....147
 KW-FS0450-03.....147
 KW-FS0460-03.....147
 KW-FS0475-03.....147
 KW-FS0650-01.....147
 LB-80X160-05.....236
 LB-80X160-20.....236
 LB-80X280-05.....236
 LB-80X280-20.....236
 LB-80X500-05.....237
 LB-80X500-20.....237
 LB-K80X80-05.....235
 LB-K80X80-20.....235
 LB-K80X100-05.....235
 LB-K80X100-20.....235
 LD-3SKL-CBN.....469
 LD-3SKL-ZBN.....469
 LD-3SKL-ZBN.....469
 LD-2835-300-20-CB.....428
 LD-2835-300-20-CB-50.....429
 LD-2835-300-20-NE.....428
 LD-2835-300-20-NE-50.....429
 LD-2835-300-20-ZB.....428
 LD-2835-300-20-ZB-50.....429
 LD-2835-300-65-CB.....428
 LD-2835-300-65-ZB.....428
 LD-3528-300-20-CB.....428
 LD-3528-300-20-CB-50.....429
 LD-3528-300-20-NE.....428
 LD-3528-300-20-NE-50.....429
 LD-3528-300-20-NI.....428
 LD-3528-300-20-ZB.....428
 LD-3528-300-20-ZB-50.....429
 LD-3528-300-65-CB.....428
 LD-3528-300-65-ZB.....428
 LD-3528-600-20-CB.....428
 LD-3528-600-20-ZB.....428
 LD-3528-600-65-CB.....428
 LD-3528-600-65-ZB.....428
 LD-3528B-300-20-CB.....429
 LD-3528B-300-20-ZB.....429
 LD-3528B-300-65-CB.....429
 LD-3528B-300-65-ZB.....429
 LD-5050-300-20-CB.....428
 LD-5050-300-20-ZB.....428
 LD-5050-300-65-CB.....428
 LD-5050-300-65-ZB.....428
 LD-5050-300-65-ZB.....428
 LD-5630-300-20-CB.....428
 LD-5630-300-20-ZB.....428
 LD-5630-300-65-CB.....428
 LD-5630-300-65-ZB.....428
 LD-AB18CB-53.....465
 LD-AB18ZB-53.....465
 LD-AL24CB-53.....455
 LD-AL24NE-53.....455
 LD-AL24ZB-53.....455
 LD-BOS1CBWB-53.....468
 LD-BOS1CBWG-53.....468
 LD-CD06ZB-53.....454
 LD-CHIC16NE-10.....468
 LD-CHIC16NE-20.....468
 LD-CO20CB-53.....464
 LD-CO20ZB-53.....464
 LD-CS36CB-53.....452
 LD-CS36NE-53.....452
 LD-CS36ZB-53.....452
 LD-CSN36CB-53.....452
 LD-CSN36ZB-53.....452
 LD-EIW09CB-CZ.....465
 LD-ES21ZB-53.....453
 LD-FL36CB-00.....466
 LD-FL36ZB-00.....466
 LD-FO120CB-40.....463
 LD-FO120ZB-40.....463
 LD-IRUSB-53.....467
 LD-IS09CB-53.....455
 LD-IS09NE-53.....455

LD-IS09ZB-53.....	455
LD-KABE2M-00.....	486
LD-KJVC0B-CB.....	450
LD-KJVC0B-ZB.....	450
LD-KLPCB-00N.....	469
LD-KLPNB-00N.....	469
LD-KLPZB-00N.....	469
LD-KONMINI-RGB.....	477
LD-KONRGB-00.....	477
LD-KWP27CB-53.....	459
LD-KWP27ZB-53.....	459
LD-LCG119-40.....	451
LD-LCG119-52.....	451
LD-LCG119-53.....	451
LD-LCG319-40.....	458
LD-LCG319-52.....	458
LD-LCG319-53.....	458
LD-LL27CB-00.....	460
LD-LL27ZB-00.....	460
LD-LU16CB-10.....	449
LD-LU16CB-20.....	449
LD-LU16CB-53.....	449
LD-LU16NE-10.....	449
LD-LU16NE-20.....	449
LD-LU16NE-53.....	449
LD-LU16ZB-10.....	449
LD-LU16ZB-20.....	449
LD-LU16ZB-53.....	449
LD-LUG119-40.....	451
LD-LUG119-52.....	451
LD-LUG119-53.....	451
LD-LUG319-40.....	458
LD-LUG319-52.....	458
LD-LUG319-53.....	458
LD-MAX60CB-40N.....	464
LD-MAX60ZB-40N.....	464
LD-NKW18CB-40.....	467
LD-NKW18ZB-40.....	467
LD-NO24CB-00.....	466
LD-NO24ZB-00.....	466
LD-OBP27CB-53.....	459
LD-OBP27ZB-53.....	459
LD-OJVC0B-CB.....	450
LD-OJVC0B-ZB.....	450
LD-OP408C-53.....	461
LD-OP456C-53.....	461
LD-OP608C-53.....	461
LD-OP609C-53.....	461
LD-OPD5W0-CB.....	462
LD-OPD9W0-CB.....	462
LD-OPT30S-51N.....	456
LD-OPT30S-52N.....	456
LD-OPT30S-53N.....	456
LD-OPT60S-51N.....	456
LD-OPT60S-52N.....	456
LD-OPT60S-53N.....	456
LD-PIRUSB-53.....	467
LD-PJVC0B-CB.....	451
LD-PJVC0B-ZB.....	451
LD-RA60CB-40.....	463
LD-RA60ZB-40.....	463
LD-RGB-150-20.....	428
LD-RGB-150-65.....	428
LD-SR16CB-53.....	462
LD-SR16NE-53.....	462
LD-SR16ZB-53.....	462
LD-SZA06W-24.....	474
LD-SZA06W-MA.....	474
LD-SZA15W-24.....	474
LD-SZA15W-MA.....	474
LD-SZA30W-MA.....	474
LD-SZA50W-MA.....	474
LD-TR24CB-53.....	456
LD-TR24ZB-53.....	456
LD-VA24CB-10.....	449
LD-VA24CB-20.....	449
LD-VA24CB-53.....	449
LD-VA24NE-10.....	449
LD-VA24NE-20.....	449

LD-VA24NE-53.....	449
LD-VA24ZB-10.....	449
LD-VA24ZB-20.....	449
LD-VA24ZB-53.....	449
LD-VE15CB-53.....	453
LD-VE15CBZB-53.....	454
LD-VE15NE-53.....	453
LD-VE15ZB-53.....	453
LD-WL2457-53.....	460
LD-Z3CSCB-53.....	457
LD-Z5CSCB-53.....	458
LD-Z50TCB-51.....	457
LD-ZAC6WDE-RGB.....	478
LD-ZAS06W-30N.....	472
LD-ZAS12W-30N.....	472
LD-ZAS15W-30N.....	472
LD-ZAS30W-30N.....	472
LD-ZAS50W-30N.....	472
LD-ZAS75W-30.....	472
LD-ZAS150-NW.....	472
LD-ZAS350-NW.....	472
LD-ZASPU15W-30N.....	473
LD-ZL5RGB150-00.....	478
LD-ZSKL15-00.....	475
LD-ZTK8MM-02N.....	489
LD-ZTK8MM-02N600.....	489
LD-ZTK10MM-02N.....	489
LD-ZTK8MM-02N.....	489
LD-ZTK8MM-02N600.....	488
LD-ZTL82M-2N.....	490
LD-ZTL82M-2N600.....	490
LD-ZTL102M-2N.....	490
LD-ZTLR6B2M-4N.....	490
LD-ZTLR6B-04N.....	488
LD-ZWN06W-10.....	475
LD-ZWN012-10.....	475
LD-ZZAS06KD6.....	476
LD-ZZAS12KD6.....	476
LD-ZZAS15KD6.....	476
LD-ZZAS30KD6.....	476
LMB-BOCZ38L-ALU.....	159
LMB-BOCZ38P-ALU.....	159
LMB-KAT28-ALU.....	159
LMB-KAT38-ALU.....	160
LMB-SZCZ28-ALU.....	160
LMB-SZCZ38-ALU.....	161
LO-00-00-001.....	158
LO-00-00-003.....	158
LO-M2M-00-125.....	153
LO-P0-00-010.....	158
LO-P0-00-030.....	158
LZ-AKZ312-10N.....	487
LZ-AKZ612-10N.....	488
LZ-KAPR2M-10.....	487
MA-MATA-0-00.....	232
MC-J01A-12-01.....	136
MC-J01A-12-06.....	136
MC-J01A-16-01.....	136
MC-J01A-16-06.....	136
MC-J01A-19-01.....	136
MC-J01A-19-06.....	136
MC-J01A-25-01.....	136
MC-J01A-25-06.....	136
MC-J02A-25-01.....	137
MC-J04A2-14-01.....	137
MC-J04A2-14-06.....	137
MC-J04A2-18-01.....	137
MC-J04A2-22-01.....	137
MC-J04A2-22-06.....	137
MC-J60A27-01.....	138
MC-J60A27-06.....	138
MC-J62-06.....	138

MC-J63-01.....	134
MC-J63-06.....	134
MC-J65-08-01.....	135
MC-J65-08-05.....	135
MC-J65-10-01.....	135
MC-J65-10-05.....	135
MC-J65-12-01.....	135
MC-J65-12-05.....	135
MC-J123-01.....	135
MC-J123-05.....	135
MC-K090-AR-01.....	139
MC-K091-SQ-01.....	139
MC-K135-06-01.....	136
MG-MENSA-010.....	156
MG-MENSA-030.....	156
MM-FI20X6X7-PL10.....	154
MM-FI20X6X7-PL20.....	154
MM-FI20X6X7-PL30.....	154
MM-FI20X6X7-PL80.....	154
MM-FI20X6X7-ZN.....	154
MP-054350-10.....	83
MP-054400-10.....	83
MP-054450-10.....	83
MP-054450-80.....	83
MP-054500-10.....	83
MP-054500-80.....	83
MP-086270-10.....	83
MP-086270-80.....	83
MP-086300-10.....	83
MP-086300-80.....	83
MP-086350-10.....	83
MP-086350-80.....	83
MP-086400-10.....	83
MP-086400-80.....	83
MP-086450-10.....	83
MP-086450-80.....	83
MP-086500-10.....	83
MP-086500-80.....	83
MP-086550-10.....	83
MP-086550-80.....	83
MP-118350-10.....	83
MP-118400-10.....	83
MP-118450-10.....	83
MP-118500-10.....	83
MP-150270-10.....	83
MP-150270-80.....	83
MP-150300-10.....	83
MP-150300-80.....	83
MP-150350-10.....	83
MP-150350-80.....	83
MP-150400-10.....	83
MP-150400-80.....	83
MP-150450-10.....	83
MP-150450-80.....	83
MP-150500-10.....	83
MP-150500-80.....	83
MP-150550-10.....	83
MP-150550-80.....	83
MR-R0050-001.....	164
MR-RDRO-0000.....	162
MR-R0525-001.....	164
MR-T1824-KPL.....	170
MR-TDLO11-01.....	141
MR-TH001-01.....	174
MR-TH002-L01.....	175
MR-TH002-P01.....	175
MR-TH004-001.....	169
MR-TH005-001.....	168
MR-TH009-001.....	172
MR-TH010-001.....	172
MR-TH011-001.....	171
MR-TH016-001.....	169
MR-TH018-KPL.....	170
MR-TH018-L01.....	175
MR-TH018-P01.....	175
MR-TH019-001.....	176
MR-TH019-003.....	177
MR-TH024-KPL.....	171
MR-TH035-KPL.....	173

MR-TH048-001.....	177	NM-BD-780-M1.....	345	NM-STGY135-100-01.....	356
MR-THA12-001.....	167	NM-BD-780-M2.....	345	NM-STGY135-120-01.....	357
MR-THB12-001.....	167	NM-BD-780-M5.....	345	NM-STGY135-130-01.....	356
MR-THQZ1-001.....	176	NM-BD867-100.....	348	NM-STGY135-150-01.....	356
MR-WP-010-01.....	166	NM-BD868-100.....	348	NM-STOMP-120-01.....	358
MR-WP-011-01.....	166	NM-BD868-150.....	348	NM-STOMP-120-20.....	357
MR-WP013-001.....	168	NM-BD869-150.....	349	NM-STOPKA-M6.....	364
MR-WP-14-KPL.....	173	NM-DAK27-060.....	353	NM-STOPKSZESTK-M6.....	365
MR-WP-15-KPL.....	174	NM-DAK27-080.....	353	NM-STPL-135-01.....	358
MR-WP-028-01.....	163	NM-DAK27-100.....	353	NM-STR50-100-01.....	346
MR-WP2802-01.....	179	NM-DAK27-120.....	353	NM-STR50-120-01.....	346
MR-WP2804-01.....	180	NM-DAK27-150.....	353	NM-STR50-150-01.....	346
MR-WP2806-01.....	180	NM-DAP77-60.....	349	NM-STR60-80-01.....	346
MR-WP2807-20.....	181	NM-DAP77-100.....	349	NM-STSL-170-60-01.....	362
MR-WP2815-01.....	179	NM-DAP77-150.....	349	NM-TOKYO40-150-01.....	354
MR-WPS01-001.....	182	NM-DPA20-100.....	367	NM-WPJ22-D20.....	363
MR-WPS03-001.....	182	NM-DPA20-100W.....	367	NM-XH3065-05.....	359
MR-WP2002-01.....	165	NM-DPA20-150.....	367	NM-XH8273-01.....	360
MR-WP2003-01.....	165	NM-DPA20-150W.....	367	OC-2PV340-01.....	225
MR-WP2006-01.....	178	NM-DPD20-100.....	366	OC-2PV340-01-18.....	225
MR-WP2023-01.....	181	NM-F50710-01.....	376	OC-2PV350-01.....	225
MR-ZSL011-01.....	141	NM-F50710-06.....	376	OC-2PV350-01-18.....	225
NM-46R710-05.....	377	NM-F50710-10.....	376	OC-2PV360-01.....	225
NM-46R820-05.....	377	NM-F50710-20.....	376	OC-2PV360-01-18.....	225
NM-60R710-05.....	377	NM-F50870-01.....	376	OC-2PV370-01.....	225
NM-60R710-06.....	377	NM-F50870-06.....	376	OC-2PV370-01-18.....	225
NM-60R710-20.....	377	NM-F50870-10.....	376	OC-2PV380-01.....	225
NM-60R820-05.....	377	NM-F50870-20.....	376	OC-2PV380-01-18.....	225
NM-380X730-01.....	378	NM-G60710-01.....	374	OC-2PV390-01.....	225
NM-480X730-01.....	378	NM-G60710-02.....	374	OC-2PV390-01-18.....	225
NM-A60710-01.....	373	NM-G60710-03.....	374	OC-A0150-06.....	224
NM-A60710-02.....	373	NM-G60710-05.....	374	OC-A0160-06.....	224
NM-A60710-05.....	373	NM-G60710-06.....	374	OC-A0170-06.....	224
NM-A60710-10.....	373	NM-G60710-20.....	374	OC-A0180-06.....	224
NM-A60710-20.....	373	NM-G60710-80.....	374	OC-A0190-06.....	224
NM-A60710-80.....	373	NM-G60820-01.....	374	OC-A0350K-06.....	226
NM-A60820-01.....	373	NM-G60820-05.....	374	OC-A0450-06.....	226
NM-A60820-02.....	373	NM-G60820-06.....	374	OC-A0460D-06.....	227
NM-A60820-05.....	373	NM-G60820-20.....	374	OC-A0660-06.....	224
NM-A60820-10.....	373	NM-G61100-01.....	374	OC-A0680-06.....	224
NM-A61100-01.....	373	NM-G61100-05.....	374	OC-E0707D-CZ.....	227
NM-A61100-02.....	373	NM-G61100-20.....	374	OM-OBK150-20.....	241
NM-A61100-05.....	373	NM-KL-DPA-20.....	367	OM-OB0300-05.....	241
NM-A61100-06.....	373	NM-KL-DPL-20.....	366	OM-OB0350-05.....	241
NM-A61100-10.....	373	NM-MDN926-01.....	360	OM-OB0400-05.....	241
NM-A61100-20.....	373	NM-MDN927-01.....	361	OM-OPW000-60.....	470
NM-B103-80-01.....	343	NM-MDN941-01.....	361	OM-OPW000-61.....	470
NM-B103-80-06.....	343	NM-MDN-D4-01.....	359	OM-ZH4200-53.....	471
NM-B103-100-01.....	343	NM-ML-50-75.....	368	OM-ZH4200-60.....	471
NM-B103-100-06.....	343	NM-ML-65-85.....	368	OM-ZH5200-53.....	471
NM-B103-120-01.....	343	NM-ML-85-125.....	369	OM-ZH5200-60.....	471
NM-B103-120-06.....	343	NM-ML-95-145.....	369	PA-0241-35-50.....	298
NM-B104-100-01.....	351	NM-ML-125-195.....	370	PA-0242-35-50.....	296
NM-B104-150-01.....	351	NM-ML-KL.....	370	PA-0243-35-50.....	297
NM-B104-200-01.....	351	NM-MUFAWB-00.....	365	PA-0244-35-50.....	297
NM-B-140-060.....	345	NM-MUFAWK-00.....	365	PA-0245-35-50.....	298
NM-B-140-080.....	345	NM-NAC-27651-06.....	350	PA-GA4560-10.....	202
NM-B-140-100.....	345	NM-NAC-27651-10.....	350	PA-GA4560-20.....	202
NM-B-140-120.....	345	NM-NAC-27651-15.....	350	PA-GLAX3M-AL.....	433
NM-B-140-150.....	345	NM-NACK27651-06.....	354	PA-GLAX-AL.....	433
NM-B-140-180.....	345	NM-NACK27651-10.....	354	PA-GLAXDR-AL.....	441
NM-B-140-200.....	345	NM-RIO-050-01.....	344	PA-GLAXKT3M-AL.....	435
NM-BAHIA40-150-01.....	350	NM-RIO-080-01.....	344	PA-GLAXKT-AL.....	435
NM-BD-001-M1B.....	355	NM-RIO-100-01.....	344	PA-GLAXMNBW3M-AL.....	447
NM-BD-003-01.....	344	NM-S60710-01(A).....	375	PA-GLAXMNBW3M-AL.....	446
NM-BD-003-02.....	344	NM-S60710-02(A).....	375	PA-GLAXMNB3M-AL.....	430
NM-BD-003-150-01.....	344	NM-S60710-05(A).....	375	PA-GLAXMNBK-AL.....	430
NM-BD-003-150-02.....	344	NM-S60710-10(A).....	375	PA-GLAXMNBK-AL.....	432
NM-BD-100-01.....	347	NM-S60710-20(A).....	375	PA-GLAXMPK-AL.....	440
NM-BD-100-02.....	347	NM-S60820-01(A).....	375	PA-GLAXMW-AL.....	434
NM-BD-100-05.....	347	NM-S60820-02(A).....	375	PA-GLAXMNB2M16-AL.....	444
NM-BD-100-06.....	347	NM-S60820-05(A).....	375	PA-GLAXMNB2M19-AL.....	444
NM-BD-150-01.....	343	NM-S60820-10(A).....	375	PA-GLAXMNB3M16-AL.....	444
NM-BD-150-02.....	343	NM-S60820-20(A).....	375	PA-GLAXMNB3M19-AL.....	444
NM-BD-712-M1.....	355	NM-SQ40ADJ-060.....	351	PA-GLAXMNB3M-AL.....	444
NM-BD727-100.....	352	NM-SQ40ADJ-100.....	351	PA-GLAXMNBW2M16-AL.....	445
NM-BD-739-05.....	353	NM-SQA100-01.....	352	PA-GLAXMNBW2M19-AL.....	445
NM-BD-762-01.....	347	NM-SQA150-01.....	352	PA-GLAXMNBW3M16-AL.....	445
NM-BD-762-05.....	347	NM-STGC50-95-01.....	356	PA-GLAXMNBW3M19-AL.....	445

PA-GLAXNBDW3M-AL.....445
PA-GLAXNBJM2M16-AL.....442
PA-GLAXNBJM19-AL.....442
PA-GLAXNBJM3M16-AL.....442
PA-GLAXNBJM3M19-AL.....442
PA-GLAXNBJM3M-AL.....442
PA-GLAXNBJW2M16-AL.....443
PA-GLAXNBJW2M19-AL.....443
PA-GLAXNBJW3M16-AL.....443
PA-GLAXNBJW3M19-AL.....443
PA-GLAXNBJW3M-AL.....443
PA-GLAXNK3M-AL.....431
PA-GLAXNK-AL.....431
PA-GLAXNKKT3M-AL.....437
PA-GLAXNKKT-AL.....437
PA-GLAXREG1-AL.....438
PA-GLAXREG2-AL.....438
PA-GLAXWN-AL.....439
PA-GLAXWPKT-AL.....436
PA-OSMLGLAX-00.....433
PA-OSMLGLAX-00.....435
PA-OSMLGLAX-00.....436
PA-OSMLGLAX-00.....437
PA-OSMLGLAX-00.....438
PA-OSMLGLAX-00.....439
PA-OSMLGLAX-00.....441
PA-OSMLGLAX-00.....442
PA-OSMLGLAX-00.....443
PA-OSMLGLAX-00.....444
PA-OSMLGLAX3M-00.....433
PA-OSMLGLAX3M-00.....435
PA-OSMLGLAX3M-00.....437
PA-OSMLGLAX3M-00.....442
PA-OSMLGLAX3M-00.....443
PA-OSMLGLAX3M-00.....444
PA-OSMLGLAX3M-00.....445
PA-OSMLGLAXM-00.....430
PA-OSMLGLAXM-00.....432
PA-OSMLGLAXM-00.....434
PA-OSMLGLAXM-00.....440
PA-OSMLGLAXM3M-00.....430
PA-OSMLGLAXM3M-00.....446
PA-OSMLGLAXM3M-00.....447
PA-OSMLGLAXMK-00.....430
PA-OSMLGLAXMK-00.....434
PA-OSMLGLAXMO-00.....430
PA-OSMLGLAXT-00.....437
PA-OSTRGLAX-00.....433
PA-OSTRGLAX-00.....435
PA-OSTRGLAX-00.....436
PA-OSTRGLAX-00.....437
PA-OSTRGLAX-00.....438
PA-OSTRGLAX-00.....439
PA-OSTRGLAX-00.....441
PA-OSTRGLAX-00.....442
PA-OSTRGLAX-00.....443
PA-OSTRGLAX-00.....444
PA-OSTRGLAX3M-00.....433
PA-OSTRGLAX3M-00.....435
PA-OSTRGLAX3M-00.....437
PA-OSTRGLAX3M-00.....442
PA-OSTRGLAX3M-00.....443
PA-OSTRGLAX3M-00.....444
PA-OSTRGLAX3M-00.....445
PA-OSTRGLAXM-00.....430
PA-OSTRGLAXM-00.....432
PA-OSTRGLAXM-00.....434
PA-OSTRGLAXM-00.....440
PA-OSTRGLAXM3M-00.....430
PA-OSTRGLAXM3M-00.....446
PA-OSTRGLAXM3M-00.....447
PA-ROZGLAX-53.....441
PA-USZGLAX-00N.....439
PA-ZASGLAX-00.....433
PA-ZASGLAXDR-00.....441
PA-ZASGLAXKT-00.....435
PA-ZASGLAXMNNK-00.....430
PA-ZASGLAXMNNKK-00.....430
PA-ZASGLAXMNNKO-00.....430

PA-ZASGLAXMNNKW-00.....432
PA-ZASGLAXMW-00.....434
PA-ZASGLAXMWK-00.....434
PA-ZASGLAXNNK-00.....431
PA-ZASGLAXNNKKT-00.....437
PA-ZASGLAXNNKKT-00.....437
PA-ZAWGLAXDR-00.....441
PB-0FPO-250.....61
PB-0FPO-270.....61
PB-0FPO-300.....61
PB-0FPO-350.....61
PB-0FPO-400.....61
PB-0FPO-450.....61
PB-0FPO-500.....61
PB-0FPO-550.....61
PB-0FPO-600.....61
PB-0M2S15-60MB.....208
PB-0M2S20-60MB.....210
PB-0M2X34-60MB.....211
PB-0SHX18-300-H.....58
PB-0SHX18-350-H.....58
PB-0SHX18-400-H.....58
PB-0SHX18-450-H.....58
PB-0SHX18-500-H.....58
PB-0SHX18-550-H.....58
PB-0SHX-250-A.....57
PB-0SHX-270-A.....57
PB-0SHX-300-A.....57
PB-0SHX-350-A.....57
PB-0SHX-400-A.....57
PB-0SHX-450-A.....57
PB-0SHX-500-A.....57
PB-0SHX-550-A.....57
PB-0SHX-600-A.....57
PB-002X15-60MB.....207
PB-002X20-60MB.....209
PB-3DOSHX18-300-H.....59
PB-3DOSHX18-350-H.....59
PB-3DOSHX18-400-H.....59
PB-3DOSHX18-450-H.....59
PB-3DOSHX18-500-H.....59
PB-3DOSHX18-550-H.....59
PB-3DSLIDE-250.....56
PB-3DSLIDE-270.....56
PB-3DSLIDE-300.....56
PB-3DSLIDE-350.....56
PB-3DSLIDE-400.....56
PB-3DSLIDE-450.....56
PB-3DSLIDE-500.....56
PB-3DSLIDE-550.....56
PB-45-002X20.....205
PB-45-0010X3.....204
PB-45-202X10.....205
PB-45-002010.....204
PB-45M002S20.....206
PB-45M202S10.....206
PB-0202X1060MB.....209
PB-90114100.....213
PB-90144100PCT.....214
PB-90934100PCT.....215
PB-90954100PCT.....215
PB-91014100.....212
PB-91024160V.....212
PB-91104100B5.....218
PB-91114100B5.....218
PB-91164100B5.....218
PB-91174100B5.....218
PB-91464100PCT.....216
PB-91474100PCT.....216
PB-91554160V.....217
PB-91564160V.....217
PB-91634100B5.....218
PB-91644100B5.....218
PB-AXIS-KPL300A.....118
PB-AXIS-KPL300A1.....118
PB-AXIS-KPL300B.....118
PB-AXIS-KPL300B1.....118
PB-AXIS-KPL300C.....119
PB-AXIS-KPL300C1.....119

PB-AXIS-KPL350A.....118
PB-AXIS-KPL350A1.....118
PB-AXIS-KPL350B.....118
PB-AXIS-KPL350B1.....118
PB-AXIS-KPL350C.....119
PB-AXIS-KPL350C1.....119
PB-AXIS-KPL400A.....118
PB-AXIS-KPL400A1.....118
PB-AXIS-KPL400B.....118
PB-AXIS-KPL400B1.....118
PB-AXIS-KPL400C.....119
PB-AXIS-KPL400C1.....119
PB-AXIS-KPL450A.....118
PB-AXIS-KPL450A1.....118
PB-AXIS-KPL450B.....118
PB-AXIS-KPL450B1.....118
PB-AXIS-KPL450C.....119
PB-AXIS-KPL450C1.....119
PB-AXIS-KPL500A.....118
PB-AXIS-KPL500A1.....118
PB-AXIS-KPL500B.....118
PB-AXIS-KPL500B1.....118
PB-AXIS-KPL500C.....119
PB-AXIS-KPL500C1.....119
PB-AXIS-KPL550A.....118
PB-AXIS-KPL550A1.....118
PB-AXIS-KPL550B.....118
PB-AXIS-KPL550B1.....118
PB-AXIS-KPL550C.....119
PB-AXIS-KPL550C1.....119
PB-AXIS-PANELWEW.....122
PB-AXIS-PANELWEW-10.....122
PB-AXIS-RELKW300.....120
PB-AXIS-RELKW300-10.....120
PB-AXIS-RELKW350.....120
PB-AXIS-RELKW350-10.....120
PB-AXIS-RELKW400.....120
PB-AXIS-RELKW400-10.....120
PB-AXIS-RELKW450.....120
PB-AXIS-RELKW450-10.....120
PB-AXIS-RELKW500.....120
PB-AXIS-RELKW500-10.....120
PB-AXIS-RELKW550.....120
PB-AXIS-RELKW550-10.....120
PB-AXIS-RP-1100.....122
PB-AXIS-RP-1100-10.....122
PB-AXIS-U2R0-00.....119
PB-AXIS-U2R0-10.....119
PB-AXIS-WEWMOCA.....120
PB-AXIS-WEWMOCA1.....120
PB-AXIS-WEWMOCB.....121
PB-AXIS-WEWMOCB1.....121
PB-AXIS-WEWMOCC.....121
PB-AXIS-WEWMOCC1.....121
PB-D-BXSID45B.....109
PB-D-BXSID45B-10.....109
PB-D-BXSID45C.....110
PB-D-BXSID45C-10.....110
PB-D-BXSID50B.....109
PB-D-BXSID50B-10.....109
PB-D-BXSID50C.....110
PB-D-BXSID50C-10.....110
PB-D-CONBXSID.....108
PB-D-CONBXSID-10.....108
PB-D-CONREL.....108
PB-D-CONREL-10.....108
PB-D-CONREL-KW.....94
PB-D-CONREL-KW-10.....94
PB-D-COR600A.....115
PB-D-COR600C.....115
PB-D-COR650A.....115
PB-D-COR650C.....115
PB-D-D2R0-00.....112
PB-D-D2R0-01.....95
PB-D-D2R0-01.....112
PB-D-DBOX450C.....110
PB-D-DBOX500C.....110
PB-D-KPL68-450-10.....114
PB-D-KPL68-450-80.....114

PB-D-KPL68-500-10.....	114	PB-D-REL3500.....	102	PB-GCHX-500.....	62
PB-D-KPL68-500-80.....	114	PB-D-REL4000.....	102	PB-GCHX-500-H.....	63
PB-D-KPL250A.....	100	PB-D-REL4500.....	102	PB-GCHX-550.....	62
PB-D-KPL250A1.....	100	PB-D-REL5000.....	102	PB-GCHX-550-H.....	63
PB-D-KPL250C.....	101	PB-D-REL5500.....	102	PB-GCHX-600.....	62
PB-D-KPL250C1.....	101	PB-D-RELCOV.....	107	PB-KW-KPL250B.....	89
PB-D-KPL300A.....	100	PB-D-RELCOV-10.....	107	PB-KW-KPL250B1-50.....	89
PB-D-KPL300A1.....	100	PB-D-RELKW350.....	90	PB-KW-KPL250C.....	89
PB-D-KPL300B.....	101	PB-D-RELKW350-10.....	90	PB-KW-KPL300A.....	89
PB-D-KPL300C.....	101	PB-D-RELKW400.....	90	PB-KW-KPL300C.....	90
PB-D-KPL300C1.....	101	PB-D-RELKW400-10.....	90	PB-KW-KPL350A.....	89
PB-D-KPL350A.....	100	PB-D-RELKW450.....	90	PB-KW-KPL350A1-50.....	89
PB-D-KPL350A1.....	100	PB-D-RELKW450-10.....	90	PB-KW-KPL350B.....	89
PB-D-KPL350B.....	101	PB-D-RELKW500.....	90	PB-KW-KPL350B1-50.....	89
PB-D-KPL350C.....	101	PB-D-RELKW500-10.....	90	PB-KW-KPL350B-50.....	89
PB-D-KPL350C1.....	101	PB-D-RELKW550.....	90	PB-KW-KPL350C.....	90
PB-D-KPL400A.....	100	PB-D-RELKW550-10.....	90	PB-KW-KPL350C1-50.....	90
PB-D-KPL400A1.....	100	PB-D-RP-1100.....	105	PB-KW-KPL400A.....	89
PB-D-KPL400B.....	101	PB-D-RP-1100-10.....	105	PB-KW-KPL400A1-50.....	89
PB-D-KPL400C.....	101	PB-D-S2R0-00.....	96	PB-KW-KPL400B.....	89
PB-D-KPL400C1.....	101	PB-D-S2R0-00.....	111	PB-KW-KPL400B1-50.....	89
PB-D-KPL450A.....	100	PB-D-S2R0-01.....	96	PB-KW-KPL400B-50.....	89
PB-D-KPL450A1.....	100	PB-D-S2R0-01.....	111	PB-KW-KPL400C.....	90
PB-D-KPL450B.....	101	PB-D-UCHWEW.....	106	PB-KW-KPL400C1-50.....	90
PB-D-KPL450C.....	101	PB-D-UCHWEW-10.....	106	PB-KW-KPL450A.....	89
PB-D-KPL450C1.....	101	PB-D-ULE-500.....	116	PB-KW-KPL450A1-50.....	89
PB-D-KPL500A.....	100	PB-D-W2R0-00.....	97	PB-KW-KPL450B.....	89
PB-D-KPL500A1.....	100	PB-D-W2R0-00.....	112	PB-KW-KPL450B1-50.....	89
PB-D-KPL500B.....	101	PB-D-W2R0-01.....	97	PB-KW-KPL450C.....	90
PB-D-KPL500C.....	101	PB-D-W2R0-01.....	112	PB-KW-KPL450C1-50.....	90
PB-D-KPL500C1.....	101	PB-D-WEWMOCA.....	102	PB-KW-KPL500A.....	89
PB-D-KPL550A.....	100	PB-D-WEWMOCA1.....	102	PB-KW-KPL500A1-50.....	89
PB-D-KPL550A1.....	100	PB-D-WEWMOCA-KW.....	91	PB-KW-KPL500B.....	89
PB-D-KPL550B.....	101	PB-D-WEWMOCA-KW-10.....	91	PB-KW-KPL500B1-50.....	89
PB-D-KPL550C.....	101	PB-D-WEWMOCCB.....	103	PB-KW-KPL500C.....	90
PB-D-KPL550C1.....	101	PB-D-WEWMOCCB1.....	103	PB-KW-KPL500C1-50.....	90
PB-D-LIS1100.....	107	PB-D-WEWMOCCB-KW.....	91	PB-KW-KPL550A.....	89
PB-D-LIS1100-10.....	107	PB-D-WEWMOCCB-KW-10.....	91	PB-KW-KPL550A1-50.....	89
PB-D-LIS1100-KW.....	94	PB-D-WEWMOCC.....	104	PB-KW-KPL550B.....	89
PB-D-LIS1100-KW-10.....	94	PB-D-WEWMOCC1.....	104	PB-KW-KPL550B-50.....	89
PB-D-LR-00-0.....	106	PB-D-WEWMOCC-KW.....	92	PB-KW-KPL550C.....	90
PB-D-LR-00-10.....	106	PB-D-WEWMOCC-KW-10.....	92	PB-KW-KPL550C1-50.....	90
PB-D-MATRYCA.....	98	PB-D-WEWSZKLC.....	103	PB-LINOS-KPL300A.....	124
PB-D-MATRYCA.....	113	PB-D-WEWSZKLC-10.....	103	PB-LINOS-KPL300A1.....	124
PB-D-MBSTAB-00.....	114	PB-D-ZLE-450.....	116	PB-LINOS-KPL350A.....	124
PB-D-MHG04.....	113	PB-D-ZLE-500.....	116	PB-LINOS-KPL350A1.....	124
PB-D-MHG04-KW.....	97	PB-D-ZNACZ-0.....	98	PB-LINOS-KPL350B.....	124
PB-D-N2R0-00.....	96	PB-D-ZNACZ-0.....	113	PB-LINOS-KPL350B1.....	124
PB-D-N2R0-00.....	111	PB-D-ZR-00-0.....	105	PB-LINOS-KPL350C.....	125
PB-D-N2R0-01.....	96	PB-D-ZR-00-10.....	105	PB-LINOS-KPL350C1.....	125
PB-D-N2R0-01.....	111	PB-D-ZR-KW-00.....	93	PB-LINOS-KPL400A.....	124
PB-D-P20250A.....	100	PB-D-ZR-KW-10.....	93	PB-LINOS-KPL400A1.....	124
PB-D-P20250C.....	101	PB-G10HX250.....	64	PB-LINOS-KPL400B.....	124
PB-D-P20300A.....	100	PB-G10HX300.....	64	PB-LINOS-KPL400B1.....	124
PB-D-P20300C.....	101	PB-G10HX350.....	64	PB-LINOS-KPL400C.....	125
PB-D-P20350A.....	100	PB-G10HX400.....	64	PB-LINOS-KPL400C1.....	125
PB-D-P20350C.....	101	PB-G10HX450.....	64	PB-LINOS-KPL450A.....	124
PB-D-P20400A.....	100	PB-G10HX500.....	64	PB-LINOS-KPL450A1.....	124
PB-D-P20400C.....	101	PB-G10HX550.....	64	PB-LINOS-KPL450B.....	124
PB-D-P20450A.....	100	PB-G10HX600.....	64	PB-LINOS-KPL450B1.....	124
PB-D-P20450C.....	101	PB-GAPO-250.....	66	PB-LINOS-KPL450C.....	125
PB-D-P20500A.....	100	PB-GAPO-270.....	66	PB-LINOS-KPL450C1.....	125
PB-D-P20500C.....	101	PB-GAPO-300.....	66	PB-LINOS-KPL450D.....	125
PB-D-P20550A.....	100	PB-GAPO-350.....	66	PB-LINOS-KPL450D1.....	125
PB-D-P20550C.....	101	PB-GAPO-400.....	66	PB-LINOS-KPL500A.....	124
PB-D-P20STAB.....	87	PB-GAPO-450.....	66	PB-LINOS-KPL500A1.....	124
PB-D-PANELWEW.....	92	PB-GAPO-500.....	66	PB-LINOS-KPL500B.....	124
PB-D-PANELWEW.....	104	PB-GAPO-550.....	66	PB-LINOS-KPL500B1.....	124
PB-D-PANELWEW-10.....	92	PB-GAPO-600.....	66	PB-LINOS-KPL500C.....	125
PB-D-PANELWEW-10.....	104	PB-GCHX-250.....	62	PB-LINOS-KPL500C1.....	125
PB-D-PRZEGLP.....	109	PB-GCHX-270.....	62	PB-LINOS-KPL500D.....	125
PB-D-PRZEGLP-10.....	109	PB-GCHX-300.....	62	PB-LINOS-KPL500D1.....	125
PB-D-PRZEGLP-KW.....	95	PB-GCHX-300-H.....	63	PB-M202X1060MB.....	210
PB-D-PRZEGLP-KW-10.....	95	PB-GCHX-350.....	62	PB-M342X1760MB.....	211
PB-D-REL450-10.....	102	PB-GCHX-350-H.....	63	PB-Q10HX250.....	65
PB-D-REL500-10.....	102	PB-GCHX-400.....	62	PB-Q10HX300.....	65
PB-D-REL550-10.....	102	PB-GCHX-400-H.....	63	PB-Q10HX350.....	65
PB-D-REL2500.....	102	PB-GCHX-450.....	62	PB-Q10HX400.....	65
PB-D-REL3000.....	102	PB-GCHX-450-H.....	63	PB-Q10HX450.....	65

PB-RP-KW1100.....	93	PK-0-H35-5000.....	77	PK-P-H45-300-GX.....	73
PB-RP-KW1100-10.....	93	PK-0-H45-250.....	74	PK-P-H45-350-GX.....	73
PB-S10C300HX.....	60	PK-0-H45-300.....	74	PK-P-H45-400-GX.....	73
PB-S10C350HX.....	60	PK-0-H45-350.....	74	PK-P-H45-450-GX.....	73
PB-S10C400HX.....	60	PK-0-H45-400.....	74	PK-P-H45-500-GX.....	73
PB-S10C450HX.....	60	PK-0-H45-450.....	74	PK-P-H45-550-GX.....	73
PB-S10C500HX.....	60	PK-0-H45-500.....	74	PK-P-H45-600-GX.....	73
PB-S10C550HX.....	60	PK-0-H45-550.....	74	PK-S-H45-250.....	71
PB-S10C600HX.....	60	PK-0-H45-600.....	74	PK-S-H45-300.....	71
PD-ECGDL-060.....	55	PK-0-H45-700.....	74	PK-S-H45-350.....	71
PD-ECGDL-080.....	55	PK-0-H53-300.....	67	PK-S-H45-400.....	71
PD-ECGDL-150.....	55	PK-0-H53-350.....	67	PK-S-H45-450.....	71
PD-G0050-N02.....	48	PK-0-H53-400.....	67	PK-S-H45-500.....	71
PD-G050-N02.....	49	PK-0-H53-450.....	67	PK-S-H45-550.....	71
PD-G0050-N10.....	47	PK-0-H53-500.....	67	PK-S-H45-600.....	71
PD-G0050-N20.....	47	PK-0-H53-550.....	67	PK-S-H45-650.....	71
PD-G0060-N02.....	48	PK-0-H53-600.....	67	PK-S-H45-700.....	71
PD-G060-N02.....	49	PK-0-H53-650.....	67	PM-LBF160-01.....	237
PD-G0060-N10.....	47	PK-0-H53-700.....	67	PM-LBF160-02.....	237
PD-G0060-N20.....	47	PK-0-H53-750.....	67	PM-LBF160-05.....	237
PD-G0080-N02.....	48	PK-0-H53-800.....	67	PM-LBF160-06.....	237
PD-G0080-N10.....	47	PK-0-H53-900.....	67	PM-LBF180-01.....	237
PD-G0080-N20.....	47	PK-0-H53-1000.....	67	PM-LBF180-02.....	237
PD-G0100-N02.....	48	PK-0-H53-1100.....	67	PM-LBF180-05.....	237
PD-G0100-N10.....	47	PK-0H17182XP.....	81	PM-LBF180-06.....	237
PD-G0100-N20.....	47	PK-0H17214XP.....	81	PM-NAR1003-512.....	149
PD-G0120-N02.....	48	PK-0H17246XP.....	81	PM-NAR1003-645.....	149
PD-G0120-N10.....	47	PK-0H17278XP.....	81	PM-NAR1003-677.....	149
PD-G0120-N20.....	47	PK-0H17310XP.....	81	PM-NAR1003-680.....	149
PD-G0150-N02.....	48	PK-0H17342XP.....	81	PM-NAR1003-695.....	149
PD-G60160-N02.....	50	PK-0H17406XP.....	81	PM-NAR1003-725.....	149
PD-G80160-N02.....	50	PK-0H17438XP.....	81	PM-NAR1003-728.....	149
PD-GAM080-N02.....	49	PK-0H45250GX1.....	75	PM-NAR1003-731.....	149
PD-GAM100-N02.....	49	PK-0H45300GX1.....	75	PM-NAR1003-732.....	149
PD-GAM120-N02.....	49	PK-0H45350GX1.....	75	PM-NAR1003-770.....	149
PD-GAM150-N02.....	49	PK-0H45400GX1.....	75	PM-NAR1003-771.....	149
PD-GPD01-001.....	51	PK-0H45450GX1.....	75	PM-NAR1004-512.....	149
PD-GPD02-002.....	51	PK-0H45500GX1.....	75	PM-NAR1004-645.....	149
PD-GPD03-005.....	51	PK-0H45550GX1.....	75	PM-NAR1004-677.....	149
PD-LIFT-HEAVY_DUTY-10.....	46	PK-0H45600GX1.....	75	PM-NAR1004-680.....	149
PD-LIFT-HEAVY_DUTY-80.....	46	PK-0H45650GX1.....	75	PM-NAR1004-695.....	149
PD-LIFT-LIGHT-10.....	46	PK-0H45700GX1.....	75	PM-NAR1004-724.....	149
PD-LIFT-LIGHT-80.....	46	PK-L-H35-300.....	76	PM-NAR1004-725.....	149
PD-LIFT-MEDIUM-10.....	46	PK-L-H35-350.....	76	PM-NAR1004-728.....	149
PD-LIFT-MEDIUM-80.....	46	PK-L-H35-400.....	76	PM-NAR1004-731.....	149
PD-LIFT-STRONG-10.....	46	PK-L-H35-450.....	76	PM-NAR1004-732.....	149
PD-LIFT-STRONG-80.....	46	PK-L-H35-500.....	76	PM-NAR1004-770.....	149
PD-MDLIFT-P1-D.....	53	PK-L-H35-550.....	76	PM-NAR1004-771.....	149
PD-MDLIFT-P2-D.....	54	PK-L-H45-250.....	68	PM-PFMH50-10.....	157
PD-MD-ZB-01.....	39	PK-L-H45-250-A.....	69	PM-PFMH50-24.....	157
PD-MD-ZB-04.....	39	PK-L-H45-300.....	68	PM-PFMH50-25.....	157
PD-PD000-001.....	52	PK-L-H45-300-A.....	69	PM-PFMH51-10.....	157
PG-AL4560-20.....	203	PK-L-H45-300-GX.....	70	PM-PFMH53-10.....	157
PG-AL6083-20.....	203	PK-L-H45-350.....	68	PM-PFMH55-25.....	157
PG-AL8311520.....	203	PK-L-H45-350-A.....	69	PM-PFMH61-10.....	157
PG-GA6083-10.....	202	PK-L-H45-350-GX.....	70	PM-PFMH64-10.....	157
PG-GA6083-20.....	202	PK-L-H45-400.....	68	PM-PFMH64-25.....	157
PG-GA8311520.....	202	PK-L-H45-400-A.....	69	PM-PFMH69-10.....	157
PG-ST4560-10.....	203	PK-L-H45-400-GX.....	70	PM-PLF160-02.....	238
PG-ST4560-20.....	203	PK-L-H45-450.....	68	PM-PLF160-05.....	238
PG-ST6083-10.....	203	PK-L-H45-450-A.....	69	PM-PLF160-10.....	238
PG-ST6083-20.....	203	PK-L-H45-450-GX.....	70	PM-PLF160-20.....	238
PG-ST83115-10.....	203	PK-L-H45-500.....	68	PM-PLF160-30.....	238
PG-ST8311520.....	203	PK-L-H45-500-A.....	69	PM-PLF160-41.....	238
PK-0-000-027.....	80	PK-L-H45-500-GX.....	70	PM-PLF160-42.....	238
PK-0H27-3000.....	79	PK-L-H45-550.....	68	PM-PLF160-43.....	238
PK-0H27-3500.....	79	PK-L-H45-550-A.....	69	PM-PLF160-44.....	238
PK-0H27-4000.....	79	PK-L-H45-550-GX.....	70	PM-PLF160-45.....	238
PK-0H27-4500.....	79	PK-L-H45-600.....	68	PM-PLF160-46.....	238
PK-0H27-5000.....	79	PK-L-H45-600-A.....	69	PM-PLF160-47.....	238
PK-0H30-2500.....	78	PK-L-H45-600-GX.....	70	PM-PLF160-48.....	238
PK-0H30-3000.....	78	PK-P-0H45-300A.....	72	PM-PLF160-49.....	238
PK-0H30-3500.....	78	PK-P-0H45-350A.....	72	PM-PLF160-50.....	238
PK-0H30-4000.....	78	PK-P-0H45-400A.....	72	PM-PLF160-51.....	238
PK-0H35-2500.....	77	PK-P-0H45-450A.....	72	PM-PLF160-52.....	238
PK-0-H35-3000.....	77	PK-P-0H45-500A.....	72	PM-PLF160-58.....	238
PK-0-H35-3500.....	77	PK-P-0H45-550A.....	72	PP-00GS01-01.....	128
PK-0-H35-4000.....	77	PK-P-0H45-600A.....	72	PP-00GS01-02.....	128
PK-0-H35-4500.....	77	PK-P-0H45-700A.....	72	PP-00GS01-05.....	128

PP-00GS02-01.....	128	PR-0B-250-30.....	85	RS-400320-14.....	291
PP-00GS02-02.....	128	PR-0B-300-10.....	85	RS-432352-01.....	291
PP-00GS02-05.....	128	PR-0B-300-30.....	85	RS-432352-02.....	291
PP-00GS02-06.....	128	PR-0B-350-10.....	85	RS-432352-05.....	291
PP-00GS03-01.....	129	PR-0B-350-30.....	85	RS-432352-06.....	291
PP-00GS03-02.....	129	PR-0B-400-10.....	85	RS-464384-01.....	291
PP-00GS03-05.....	129	PR-0B-400-30.....	85	RS-464384-02.....	291
PP-00GS03-06.....	129	PR-0B-450-10.....	85	RS-464384-05.....	291
PP-00GS04-01.....	129	PR-0B-450-30.....	85	RS-464384-06.....	291
PP-00GS04-02.....	129	PR-0B-500-10.....	85	RS-496416-01.....	291
PP-00GS04-05.....	129	PR-0B-500-30.....	85	RS-496416-02.....	291
PP-00GS04-06.....	129	PR-0B-550-10.....	85	RS-496416-05.....	291
PP-20BUW0-05.....	187	PR-0B-550-30.....	85	RS-496416-06.....	291
PP-DP0105-01.....	127	PR-0B-600-10.....	85	RS-528448-01.....	291
PP-DP0105-02.....	127	PR-0B-600-30.....	85	RS-528448-02.....	291
PP-DP0105-05.....	127	PR-SP-250-10.....	84	RS-528448-05.....	291
PP-DP0105-06.....	127	PR-SP-300-10.....	84	RS-528448-06.....	291
PP-GL-A48-01.....	130	PR-SP-350-10.....	84	RS-560480-01.....	291
PP-GL-B48-01.....	130	PR-SP-400-10.....	84	RS-560480-02.....	291
PP-GL-CGP-01.....	131	PR-SP-450-10.....	84	RS-560480-05.....	291
PP-GL-DR5-01.....	140	PR-SP-500-10.....	84	RS-560480-06.....	291
PP-GL-E410-01.....	131	PR-SP-550-10.....	84	RS-592512-01.....	291
PP-GL-F46B-01.....	132	PR-SP-600-10.....	84	RS-592512-02.....	291
PP-HS0006-01.....	133	PU-KEY027-20.....	233	RS-592512-05.....	291
PP-HS2710-01.....	134	PU-KEY027-60.....	233	RS-592512-06.....	291
PP-LUK-00-01.....	142	PU-KEYM27-20.....	233	RS-624544-01.....	291
PP-LUK-00-02.....	142	PU-KEYM27-60.....	233	RS-624544-02.....	291
PP-LUK-00-05.....	142	PU-PKO-00-20.....	234	RS-624544-05.....	291
PP-MP0055-01.....	126	PU-PKO-00-60.....	234	RS-624544-06.....	291
PP-MP0055-02.....	126	PW-PC31209-00N.....	448	RS-SZ-400-10.....	86
PP-MP0055-05.....	126	PW-PC61209-00.....	448	RS-SZ-450-10.....	86
PP-MP0055-06.....	126	RR-161030H01.....	163	RS-SZ-450-80.....	86
PP-MP0055-10.....	126	RR-161230H01.....	163	RS-SZ-500-10.....	86
PP-MP0055-20.....	126	RR-250730H01.....	163	RS-SZ-500-80.....	86
PP-NW09X90B.....	142	RR-250830H01.....	163	RS-TRIES-96-06.....	290
PP-NW10X100B.....	142	RR-250930H01.....	163	RS-TRIES-128-06.....	290
PP-NW10X145B.....	142	RR-251030H01.....	163	RS-TRIES-160-06.....	290
PP-NW12X120B.....	142	RR-401230H01.....	163	RS-TRIES-192-06.....	290
PP-NW14X120B.....	142	RR-501030H01.....	163	RS-TRIES-256-06.....	290
PP-NW14X140B.....	142	RR-501230H01.....	163	RS-TRIES-320-06.....	290
PP-NW14X165B.....	142	RR-CH-OW-000.....	162	SB-A60X72-80.....	378
PP-OBUW60-05.....	188	RS-156096-01.....	291	SZ-005-00-01.....	155
PP-OBUW60-PW.....	188	RS-156096-02.....	291	SZ-008-00-01.....	155
PP-OBUW70-05.....	188	RS-156096-05.....	291	TE-150000-30.....	476
PP-OBUW70-PW.....	188	RS-156096-06.....	291	TE-150000-30.....	476
PP-OBUW80-05.....	188	RS-156096-14.....	291	TE-200000-30.....	476
PP-OBUW80-PW.....	188	RS-188128-01.....	291	TE-200000-30.....	476
PP-OBUW90-05.....	188	RS-188128-02.....	291	TE-600000-30.....	476
PP-OBUW90-PW.....	188	RS-188128-05.....	291	UA-00-313128.....	270
PP-P04570-20.....	201	RS-188128-06.....	291	UA-00-313160.....	270
PP-P80110-20.....	201	RS-188128-14.....	291	UA-00-313192.....	270
PP-PMONT0D-01.....	148	RS-220160-01.....	291	UA-00-319096.....	271
PP-PMONT0D-07.....	148	RS-220160-02.....	291	UA-00-319128.....	271
PP-PMONT0D-08.....	148	RS-220160-05.....	291	UA-00-319160.....	271
PP-PMONT0D-11.....	148	RS-220160-06.....	291	UA-00-326096.....	292
PP-PMONT0D-20.....	148	RS-220160-14.....	291	UA-00-326096-20M.....	292
PP-PMONT0D-22.....	148	RS-272192-01.....	291	UA-00-326128.....	292
PP-PMONT0D-41.....	148	RS-272192-02.....	291	UA-00-326128-20M.....	292
PP-PMONT0D-50.....	148	RS-272192-05.....	291	UA-00-326160-20M.....	292
PP-PMONT0D-724.....	148	RS-272192-06.....	291	UA-00-337096.....	277
PP-PMONT0D-732.....	148	RS-272192-14.....	291	UA-00-337096-20M.....	277
PP-PMONTOM-01.....	148	RS-304224-01.....	291	UA-00-337128.....	277
PP-PMONTOM-07.....	148	RS-304224-02.....	291	UA-00-337128-20M.....	277
PP-PMONTOM-08.....	148	RS-304224-05.....	291	UA-00-337160.....	277
PP-PMONTOM-11.....	148	RS-304224-06.....	291	UA-00-337160-20M.....	277
PP-PMONTOM-20.....	148	RS-304224-14.....	291	UA-00-337192.....	277
PP-PMONTOM-22.....	148	RS-336256-01.....	291	UA-00-337192-20M.....	277
PP-SOL003-01.....	132	RS-336256-02.....	291	UA-00-337224.....	277
PP-SOL012-01.....	133	RS-336256-05.....	291	UA-00-337224-20M.....	277
PP-SMART-000.....	141	RS-336256-06.....	291	UA-00-337256.....	277
PP-SP0075-01.....	127	RS-336256-14.....	291	UA-00-337256-20M.....	277
PP-SP0075-02.....	127	RS-368288-01.....	291	UA-00-337320.....	277
PP-SP0075-05.....	127	RS-368288-02.....	291	UA-00-337320-20M.....	277
PP-SP0075-06.....	127	RS-368288-05.....	291	UA-00-338128.....	277
PP-SPL001-01.....	140	RS-368288-06.....	291	UA-00-338160.....	277
PP-XS0045-01.....	126	RS-400320-01.....	291	UA-00-340128.....	278
PP-XS0045-02.....	126	RS-400320-02.....	291	UA-00-340160.....	278
PP-XS0045-05.....	126	RS-400320-05.....	291	UA-00-340192.....	278
PR-0B-250-10.....	85	RS-400320-06.....	291	UA-00-340224.....	278

UA-00-340256.....	278
UA-00-340320.....	278
UA-00-347128.....	278
UA-00-347160.....	278
UA-00-347192.....	278
UA-00-347224.....	278
UA-00-347256.....	278
UA-00-347320.....	278
UA-01-326096-V1.....	292
UA-01-326128-V1.....	292
UA-01-326160.....	292
UA-18-128146.....	270
UA-18-160178.....	270
UA-18-192210.....	270
UA-18-224242.....	270
UA-18-256274.....	270
UA-18-320338.....	270
UA-18-400418.....	270
UA-18-416434.....	270
UA-18-480498.....	270
UA-A3-096128.....	267
UA-A3-128160.....	267
UA-A3-160192.....	267
UA-A3-192224.....	267
UA-A3-256288.....	267
UA-A3-320352.....	267
UA-A4-128-06MJ.....	268
UA-A4-160-06MJ.....	268
UA-A4-256-06MJ.....	268
UA-A4-320-06MJ.....	268
UA-A18128-01.....	270
UA-A18128-06MJ.....	270
UA-A18160-01.....	270
UA-A18160-06MJ.....	270
UA-A18192-01.....	270
UA-A18192-06MJ.....	270
UA-A18224-01.....	270
UA-A18224-06MJ.....	270
UA-A18256-01.....	270
UA-A18256-06MJ.....	270
UA-A18320-01.....	270
UA-A18320-06MJ.....	270
UA-A18400-01.....	270
UA-A18400-06MJ.....	270
UA-A18416-01.....	270
UA-A18416-06MJ.....	270
UA-A18480-01.....	270
UA-A18480-06MJ.....	270
UA-AA-04-128.....	268
UA-AA-04-160.....	268
UA-AA-04-192.....	268
UA-AA-04-224.....	268
UA-AA-04-256.....	268
UA-AA-04-288.....	268
UA-AA-04-320.....	268
UA-AA-114-02.....	269
UA-AA-114-05.....	269
UA-ALFA-32-05.....	273
UA-ALFA-96-05.....	273
UA-ALFA-128-05.....	273
UA-ALFA-160-05.....	273
UA-ALFA-192-05.....	273
UA-ALFA-224-05.....	273
UA-ALFA-256-05.....	273
UA-ALFA-288-05.....	273
UA-ALFA-320-05.....	273
UA-ARSO96-20.....	251
UA-ARS128-20.....	251
UA-ARS160-20.....	251
UA-ARS192-20.....	251
UA-ARS224-20.....	251
UA-ARS256-20.....	251
UA-ARS320-20.....	251
UA-ARS630-20.....	251
UA-BO-311096.....	268
UA-BO-311096-20M.....	268
UA-BO-311128.....	268
UA-BO-311128-20M.....	268
UA-BO-311160.....	268

UA-BO-311160-20M.....	268
UA-BO-311192.....	268
UA-BO-311192-20M.....	268
UA-BO-311224.....	268
UA-BO-311224-20M.....	268
UA-BO-311256.....	268
UA-BO-311256-20M.....	268
UA-BO-311288.....	268
UA-BO-311320.....	268
UA-BO-311320-20M.....	268
UA-BO-311480.....	268
UA-BO-337128.....	269
UA-BO-337160.....	269
UA-BO-337192.....	269
UA-BO-337224.....	269
UA-BO-337256.....	269
UA-BO-337320.....	269
UA-B31109606MJ.....	268
UA-B31112801.....	268
UA-B31112806MJ.....	268
UA-B31116001.....	268
UA-B31116006MJ.....	268
UA-B31119201.....	268
UA-B31119206MJ.....	268
UA-B31122401.....	268
UA-B31122406MJ.....	268
UA-B31125601.....	268
UA-B31125606MJ.....	268
UA-B31128806MJ.....	268
UA-B31132001.....	268
UA-B31132006MJ.....	268
UA-B31148006MJ.....	268
UA-B33712801.....	269
UA-B33712806MJ.....	269
UA-B33716001.....	269
UA-B33716006MJ.....	269
UA-B33719201.....	269
UA-B33719206MJ.....	269
UA-B33722401.....	269
UA-B33722406MJ.....	269
UA-B33725601.....	269
UA-B33725606MJ.....	269
UA-B33732001.....	269
UA-B33732006MJ.....	269
UA-B33741606MJ.....	269
UA-B33748001.....	269
UA-B33748006MJ.....	269
UA-BETA-96-05.....	274
UA-BETA-128-05.....	274
UA-BETA-160-05.....	274
UA-BETA-192-05.....	274
UA-BETA-224-05.....	274
UA-BETA-256-05.....	274
UA-BETA-288-05.....	274
UA-BETA-320-05.....	274
UA-BO-337416.....	269
UA-BO-337480.....	269
UA-DELTA-96-05.....	275
UA-DELTA-128-05.....	275
UA-DELTA-160-05.....	275
UA-DELTA-192-05.....	275
UA-DELTA-224-05.....	275
UA-DELTA-256-05.....	275
UA-DELTA-288-05.....	275
UA-DELTA-320-05.....	275
UA-DOPPIO192-01.....	272
UA-DOPPIO16-01.....	272
UA-GAMMA-96-05.....	274
UA-GAMMA-128-05.....	274
UA-GAMMA-160-05.....	274
UA-GAMMA-192-05.....	274
UA-GAMMA-224-05.....	274
UA-GAMMA-256-05.....	274
UA-GAMMA-288-05.....	274
UA-GAMMA-320-05.....	274
UA-HEXI-01.....	295
UA-HEXI-05.....	295
UA-HEXI-10M.....	295
UA-HEXI-20M.....	295

UA-HEXI96-01.....	295
UA-HEXI96-05.....	295
UA-HEXI96-10M.....	295
UA-HEXI96-20M.....	295
UA-HEXI192-01.....	295
UA-HEXI192-05.....	295
UA-HEXI192-10M.....	295
UA-HEXI192-20M.....	295
UA-HEXI-3500-05.....	295
UA-KAPPA-96-05.....	276
UA-KAPPA-128-05.....	276
UA-KAPPA-160-05.....	276
UA-KAPPA-192-05.....	276
UA-KAPPA-224-05.....	276
UA-KAPPA-256-05.....	276
UA-KAPPA-288-05.....	276
UA-KAPPA-320-05.....	276
UA-LUNA20160-AL.....	271
UA-LUNA20160-SN.....	271
UA-LUNA20192-AL.....	271
UA-LUNA20192-SN.....	271
UA-LUNA20256-AL.....	271
UA-LUNA20256-SN.....	271
UA-LUNA20320-AL.....	271
UA-LUNA20320-SN.....	271
UA-METRO-224-496-18-01.....	299
UA-METRO-224-496-18-05.....	299
UA-METRO-256-296-18-01.....	299
UA-METRO-256-296-18-05.....	299
UA-METRO-256-596-18-01.....	299
UA-METRO-256-596-18-05.....	299
UA-METRO-320-396-18-01.....	299
UA-METRO-320-396-18-05.....	299
UA-METRO-352-796-18-01.....	299
UA-METRO-352-796-18-05.....	299
UA-PAXO-32-50-05.....	295
UA-PAXO-96-150-05.....	295
UA-PAXO-224-250-05.....	295
UA-PAXO-320-350-05.....	295
UA-PAXO-3500-05.....	295
UA-PICCO-64-05.....	273
UA-PICCO-128-05.....	273
UA-PICCO-224-05.....	273
UA-SIGMA-96-05.....	275
UA-SIGMA-128-05.....	275
UA-SIGMA-160-05.....	275
UA-SIGMA-192-05.....	275
UA-SIGMA-224-05.....	275
UA-SIGMA-256-05.....	275
UA-SIGMA-288-05.....	275
UA-SIGMA-320-05.....	275
UA-TREX-32-50-05.....	296
UA-TREX-96-150-05.....	296
UA-TREX-224-250-05.....	296
UA-TREX-320-350-05.....	296
UA-TREX-3500-05.....	296
UM-KID-A-001.....	327
UM-KID-B-001.....	327
UM-KID-C-001.....	326
UM-KID-D-001.....	326
UM-KID-E-001.....	326
UM-KID-F-001.....	326
UM-KID-G-001.....	326
UM-KID-I-001.....	327
UM-KID-I-002.....	326
UM-KID-O-001.....	327
UM-KID-P-001.....	326
UM-KID-Q-001.....	326
UM-KID-S-001.....	326
UM-KID-T-001.....	327
UM-KID-U-001.....	326
UM-KID-W-001.....	327
UM-KID-X-001.....	327
UM-KID-Y-001.....	326
UM-KID-Z-001.....	327
UP-WP0728-BB.....	300
UP-WP0728-BK.....	300
UP-WP0728-BR.....	300
UP-WP0728-BX.....	300

UP-WP0728-P0.....	301	UZ-04-096-02.....	281	UZ-682160-06.....	261
UP-WP0728-PA-04.....	301	UZ-04-096-03.....	281	UZ-682192-06.....	261
UP-WP0728-PA-07.....	301	UZ-04-096-05.....	281	UZ-682224-06.....	261
UP-WP0728-PB.....	301	UZ-04-128-01.....	281	UZ-682256-06.....	261
UP-WP0728-PC-04.....	301	UZ-04-128-02.....	281	UZ-682320-06.....	261
UP-WP0728-PK.....	301	UZ-04-128-03.....	281	UZ-682416-06.....	261
UP-WP0728-PR.....	301	UZ-04-128-05.....	281	UZ-682480-06.....	261
UP-WP0728-PX.....	301	UZ-05-096-01.....	281	UZ-804064-01.....	262
US-C1-064-06.....	287	UZ-05-096-02.....	281	UZ-819096-01.....	263
US-C1-096-06.....	287	UZ-05-096-03.....	281	UZ-819096-02.....	263
US-C1-128-06.....	287	UZ-05-096-05.....	281	UZ-819096-05.....	263
US-C1-160-06.....	287	UZ-05-128-01.....	281	UZ-819096-06.....	263
US-C7-096-01.....	287	UZ-05-128-02.....	281	UZ-819096-07D.....	263
US-C7-096-06.....	287	UZ-05-128-03.....	281	UZ-819096-10.....	263
US-C7-128-01.....	287	UZ-05-128-05.....	281	UZ-819096-12.....	263
US-C7-128-06.....	287	UZ-06-128-01.....	282	UZ-819096-14.....	263
US-C7-160-01.....	287	UZ-06-128-02.....	282	UZ-819096-20.....	263
US-C7-160-06.....	287	UZ-06-128-03.....	282	UZ-819128-01.....	263
US-C7-192-01.....	287	UZ-06-128-05.....	282	UZ-819128-02.....	263
US-C7-192-06.....	287	UZ-07-096-01.....	282	UZ-819128-05.....	263
US-C7-224-01.....	287	UZ-07-096-02.....	282	UZ-819128-06.....	263
US-C7-224-06.....	287	UZ-07-096-03.....	282	UZ-819128-07D.....	263
US-C7-256-01.....	287	UZ-07-096-05.....	282	UZ-819128-10.....	263
US-C7-256-06.....	287	UZ-10-096-N04.....	303	UZ-819128-12.....	263
US-C7-288-01.....	287	UZ-12-096-04.....	304	UZ-819128-14.....	263
US-C7-288-06.....	287	UZ-12-096-20M.....	304	UZ-819128-20.....	263
US-C7-320-01.....	287	UZ-13-096-01.....	283	UZ-819160-01.....	263
US-C7-320-06.....	287	UZ-13-096-02.....	283	UZ-819160-02.....	263
US-C7-352-01.....	287	UZ-13-096-03.....	283	UZ-819160-05.....	263
US-C7-352-06.....	287	UZ-13-096-05.....	283	UZ-819160-06.....	263
US-SK0128-06.....	267	UZ-14-096-01.....	284	UZ-819160-07D.....	263
US-SK0160-06.....	267	UZ-14-096-02.....	284	UZ-819160-10.....	263
US-SK0192-06.....	267	UZ-14-096-03.....	284	UZ-819160-12.....	263
US-SK0224-06.....	267	UZ-14-096-05.....	284	UZ-819160-14.....	263
US-SK0256-06.....	267	UZ-14-128-01.....	284	UZ-819160-20.....	263
US-SK0320-06.....	267	UZ-14-128-02.....	284	UZ-819192-01.....	263
US-SK0384-06.....	267	UZ-14-128-03.....	284	UZ-819192-02.....	263
US-SK0448-06.....	267	UZ-14-128-05.....	284	UZ-819192-05.....	263
US-SK0480-06.....	267	UZ-19-032-01.....	288	UZ-819192-06.....	263
US-SK0576-06.....	267	UZ-19-032-02.....	288	UZ-819192-07D.....	263
US-SK0672-06.....	267	UZ-19-032-06.....	288	UZ-819192-10.....	263
US-SK0800-06.....	267	UZ-40-032-01.....	257	UZ-819192-12.....	263
US-SKA128-06.....	266	UZ-40-032-02.....	257	UZ-819192-14.....	263
US-SKA160-06.....	266	UZ-40-032-05.....	257	UZ-819192-20.....	263
US-SKA192-06.....	266	UZ-40-032-06.....	257	UZ-819256-01.....	263
US-U4-064-01.....	289	UZ-55-025-01.....	257	UZ-819256-02.....	263
US-U4-064-06.....	289	UZ-55-025-05.....	257	UZ-819256-05.....	263
US-U4-096-01.....	289	UZ-60-032-01.....	258	UZ-819256-06.....	263
US-U4-096-06.....	289	UZ-60-032-02.....	258	UZ-819256-07D.....	263
US-U4-128-01.....	289	UZ-60-032-05.....	258	UZ-819256-10.....	263
US-U4-128-06.....	289	UZ-60-032-06.....	258	UZ-819256-12.....	263
US-U4-160-01.....	289	UZ-71C096-01.....	319	UZ-819256-14.....	263
US-U4-160-06.....	289	UZ-79F160-01.....	258	UZ-819256-20.....	263
US-U4-192-01.....	289	UZ-79F160-06.....	258	UZ-819320-01.....	263
US-U4-192-06.....	289	UZ-79F192-01.....	258	UZ-819320-02.....	263
US-U4-320-01.....	289	UZ-79F192-06.....	258	UZ-819320-05.....	263
US-U4-320-06.....	289	UZ-133128-01.....	259	UZ-819320-06.....	263
UZ-00B224-01.....	293	UZ-133128-02.....	259	UZ-819320-07D.....	263
UZ-00B224-02.....	293	UZ-133128-05.....	259	UZ-819320-10.....	263
UZ-00B224-05.....	293	UZ-133128-06.....	259	UZ-819320-12.....	263
UZ-00B224-10.....	293	UZ-334128-06.....	260	UZ-819320-14.....	263
UZ-00B224-20.....	293	UZ-334160-06.....	260	UZ-819320-20.....	263
UZ-00B226-01.....	293	UZ-334192-06.....	260	UZ-870128-01.....	264
UZ-00B226-02.....	293	UZ-334256-06.....	260	UZ-872224-01.....	265
UZ-00B226-05.....	293	UZ-334320-06.....	260	UZ-872224-05.....	265
UZ-00B226-10.....	293	UZ-335128-06.....	260	UZ-872224-06.....	265
UZ-00B226-20.....	293	UZ-335160-06.....	260	UZ-880016-01.....	265
UZ-01-096-01.....	280	UZ-335192-06.....	260	UZ-883016-01.....	266
UZ-01-096-02.....	280	UZ-335256-06.....	260	UZ-883016-02.....	266
UZ-01-096-03.....	280	UZ-336128-06.....	261	UZ-883016-05.....	266
UZ-01-096-05.....	280	UZ-336160-06.....	261	UZ-883016-06.....	266
UZ-01-128-01.....	280	UZ-336192-06.....	261	UZ-ABIAT-128-04.....	308
UZ-01-128-02.....	280	UZ-336256-06.....	261	UZ-ACERA-96-04.....	309
UZ-01-128-03.....	280	UZ-336320-06.....	261	UZ-ACRYL-Z111160.....	248
UZ-01-128-05.....	280	UZ-336416-06.....	261	UZ-ADRIN-96-04.....	309
UZ-02C064-01.....	319	UZ-336480-06.....	261	UZ-AGIOS-128-01.....	246
UZ-02C096-01.....	319	UZ-605032-01.....	289	UZ-AGIOS-128-05.....	246
UZ-02CF27-01.....	319	UZ-605032-05.....	289	UZ-ALATR-128-04.....	301
UZ-04-096-01.....	281	UZ-682128-06.....	261	UZ-ALRA096-01.....	276

UZ-ALRA096-06.....	276	UZ-COMO096-01.....	322	UZ-MILAN-128-05.....	264
UZ-ANCON-128-01.....	254	UZ-COMO128-01.....	322	UZ-MILAN-128-06.....	264
UZ-ANCON-128-05.....	254	UZ-COMO160-01.....	322	UZ-MILAN-256-01.....	264
UZ-ANCON-128-06.....	254	UZ-CR0333-A1.....	320	UZ-MILAN-256-05.....	264
UZ-ANCON-192-01.....	254	UZ-CR0333-B1.....	320	UZ-MILAN-256-06.....	264
UZ-ANCON-192-05.....	254	UZ-CRA14-128.....	320	UZ-MONA-128-01-10.....	247
UZ-ANCON-192-06.....	254	UZ-CRA14-192.....	320	UZ-MONA-128-01-20.....	247
UZ-ANCON-256-01.....	254	UZ-CRA14-320.....	320	UZ-MONA-160-01-10.....	247
UZ-ANCON-256-05.....	254	UZ-E6-096-01.....	292	UZ-MONA-160-01-20.....	247
UZ-ANCON-256-06.....	254	UZ-E6-096-05.....	292	UZ-MONA-192-01-10.....	247
UZ-ANZIO-96-04.....	311	UZ-E6-096-06.....	292	UZ-MONA-192-01-20.....	247
UZ-APRIL-96-04.....	306	UZ-E6-128-01.....	292	UZ-MONA-256-01-10.....	247
UZ-ARCH096-AEB.....	307	UZ-E6-128-05.....	292	UZ-MONA-256-01-20.....	247
UZ-ARDEA-96-04.....	305	UZ-E6-128-06.....	292	UZ-MONA-320-01-10.....	247
UZ-AREZO-96-04.....	308	UZ-E6-160-01.....	292	UZ-MONA-320-01-20.....	247
UZ-ASTI096/128-01.....	251	UZ-E6-160-05.....	292	UZ-MONZA16-06.....	247
UZ-ASTI1192/224-01.....	251	UZ-E6-160-06.....	292	UZ-MONZA16-10.....	247
UZ-ASTI288/320-01.....	251	UZ-ERIS128-01.....	321	UZ-MONZA16-20.....	247
UZ-AVELLI-96-04.....	307	UZ-ERIS128-11.....	321	UZ-MONZA160-06.....	247
UZ-AZ-012-04.....	311	UZ-G1-128-01.....	280	UZ-MONZA160-10.....	247
UZ-AZ-128-04.....	311	UZ-G1-128-05.....	280	UZ-MONZA160-20.....	247
UZ-AZ-160-04.....	311	UZ-G1-128-06.....	280	UZ-MONZA256-06.....	247
UZ-BAGIO-128-01.....	252	UZ-G1-128-13.....	280	UZ-MONZA256-10.....	247
UZ-BAGIO-128-04.....	252	UZ-G1-160-01.....	280	UZ-MONZA256-20.....	247
UZ-BAGIO-128-05.....	252	UZ-G1-160-05.....	280	UZ-MONZA384-06.....	247
UZ-BAGIO-128-06.....	252	UZ-G1-160-06.....	280	UZ-MONZA384-10.....	247
UZ-BAGIO-128-11.....	252	UZ-G1-160-13.....	280	UZ-MONZA384-20.....	247
UZ-BAGIO-160-01.....	252	UZ-G1-192-01.....	280	UZ-O160PR-01.....	248
UZ-BAGIO-160-04.....	252	UZ-G1-192-05.....	280	UZ-O192PR-01.....	248
UZ-BAGIO-160-05.....	252	UZ-G1-192-06.....	280	UZ-O256PR-01.....	248
UZ-BAGIO-160-06.....	252	UZ-G1-192-13.....	280	UZ-OLBIA-96-04.....	310
UZ-BAGIO-160-11.....	252	UZ-G1-256-01.....	280	UZ-OLBIA-128-04.....	310
UZ-BAGIO-192-01.....	252	UZ-G1-256-05.....	280	UZ-ORI160-08.....	250
UZ-BAGIO-192-04.....	252	UZ-G1-256-06.....	280	UZ-PADWA128-01.....	255
UZ-BAGIO-192-05.....	252	UZ-G1-256-13.....	280	UZ-PADWA128-06.....	255
UZ-BAGIO-192-06.....	252	UZ-G1-320-01.....	280	UZ-PADWA160-01.....	255
UZ-BAGIO-192-11.....	252	UZ-G1-320-05.....	280	UZ-PADWA160-06.....	255
UZ-BAGIO-320-01.....	252	UZ-G1-320-06.....	280	UZ-PADWA192-01.....	255
UZ-BAGIO-320-04.....	252	UZ-G1-320-13.....	280	UZ-PADWA192-06.....	255
UZ-BAGIO-320-05.....	252	UZ-G1-416-01.....	280	UZ-PADWA224-01.....	255
UZ-BAGIO-320-06.....	252	UZ-G1-416-05.....	280	UZ-PADWA224-06.....	255
UZ-BAGIO-320-11.....	252	UZ-G1-416-06.....	280	UZ-PALER-96-07.....	302
UZ-BELLA160-09.....	303	UZ-G2-160-01.....	252	UZ-PALER-128-07.....	302
UZ-BIANC-96-01.....	323	UZ-G2-160-06.....	252	UZ-PRATO-160-01.....	253
UZ-BIANC-128-01.....	323	UZ-G2-224-01.....	252	UZ-PRATO-160-05.....	253
UZ-CAD128-01.....	249	UZ-G2-224-06.....	252	UZ-PRATO-160-06.....	253
UZ-CAD160-01.....	249	UZ-GANZA-160-01.....	245	UZ-PRATO-320-01.....	253
UZ-CAD160-05.....	249	UZ-GANZA-160-05.....	245	UZ-PRATO-320-05.....	253
UZ-CAD320-01.....	249	UZ-GANZA-160-10.....	245	UZ-PRATO-320-06.....	253
UZ-CAD320-05.....	249	UZ-GANZA-160-12.....	245	UZ-R132-A1-01.....	294
UZ-CALABRIA160-01.....	279	UZ-GENUA128-01.....	279	UZ-R132-A1-02.....	294
UZ-CALABRIA160-06.....	279	UZ-GENUA128-02.....	279	UZ-R132-A1-06.....	294
UZ-CALABRIA192-01.....	279	UZ-GENUA128-05.....	279	UZ-R160BI-01.....	249
UZ-CALABRIA192-06.....	279	UZ-GENUA160-01.....	279	UZ-R160PR-01.....	249
UZ-CALABRIA224-01.....	279	UZ-GENUA160-02.....	279	UZ-R256BI-01.....	249
UZ-CALABRIA224-06.....	279	UZ-GENUA160-05.....	279	UZ-R256PR-01.....	249
UZ-CAMAI-96-01.....	284	UZ-HILL-128-01.....	246	UZ-RENO96-04A.....	316
UZ-CAMAI-96-02.....	284	UZ-HILL-128-05.....	246	UZ-RENG01-04A.....	316
UZ-CAMAI-96-06.....	284	UZ-HILL-128-06.....	246	UZ-RENG02-04A.....	316
UZ-CAMAI-96-09.....	284	UZ-HILL-128-12.....	246	UZ-ROSL60-20.....	249
UZ-CAMAI-96-10M.....	284	UZ-HILL-160-01.....	246	UZ-ROSL256-20.....	249
UZ-CAMAI-96-12.....	284	UZ-HILL-160-05.....	246	UZ-ROYAL1-96-10/03.....	313
UZ-CAMAI-96-20M.....	284	UZ-HILL-160-06.....	246	UZ-ROYAL2-96-10/03.....	313
UZ-CAMAI-128-01.....	284	UZ-HILL-160-12.....	246	UZ-ROYAL3-96-10/03.....	313
UZ-CAMAI-128-02.....	284	UZ-IZIS40-01.....	321	UZ-ROYAL4-96-03.....	313
UZ-CAMAI-128-06.....	284	UZ-IZIS40-11.....	321	UZ-ROYAL5-96-10-03.....	313
UZ-CAMAI-128-09.....	284	UZ-KATAN-320-01.....	255	UZ-ROYAL5-128-10-03.....	313
UZ-CAMAI-128-10M.....	284	UZ-KATAN-320-12.....	255	UZ-S50-A1-01.....	294
UZ-CAMAI-128-12.....	284	UZ-LATIN-96-04.....	310	UZ-S50-A1-02.....	294
UZ-CAMAI-128-20M.....	284	UZ-LUCCA096-01.....	323	UZ-S50-A1-05.....	294
UZ-CLEO-128-01.....	244	UZ-LUCCA128-01.....	323	UZ-S50-A1-06.....	294
UZ-CLEO-128-05.....	244	UZ-LUCCA160-01.....	323	UZ-SENIOR-160-01.....	244
UZ-CLEO-128-06.....	244	UZ-LUCCA192-01.....	323	UZ-SENIOR-160-05.....	244
UZ-CLEO-160-01.....	244	UZ-MARSA-64-07.....	312	UZ-SIENNA096-01.....	322
UZ-CLEO-160-05.....	244	UZ-MARSA-64-09.....	312	UZ-SIENNA128-01.....	322
UZ-CLEO-160-06.....	244	UZ-MARSA-64-10M.....	312	UZ-SIENNA160-01.....	322
UZ-CLEO-192-01.....	244	UZ-MARSA-64-11.....	312	UZ-SOLANA192-01.....	254
UZ-CLEO-192-05.....	244	UZ-MARSA-64-20M.....	312	UZ-SOLANA192-09.....	254
UZ-CLEO-192-06.....	244	UZ-MILAN-128-01.....	264	UZ-SOLANA192-11.....	254

UZ-SOLANA320-01.....	254	WB-073025-06.....	143	WW-KOSZ90-05.....	189
UZ-SOLANA320-09.....	254	WB-073026-01.....	144	WW-KOSZ90-PW.....	189
UZ-SOLANA320-11.....	254	WB-073026-06.....	144	WW-KRAW00-20.....	195
UZ-TH096128-01.....	272	WB-WS-12-001.....	144	W-WKRP-BP-60.....	185
UZ-TH096128-02.....	272	WB-WS-12-010.....	144	W-WKRP-GX-60.....	185
UZ-TH096128-05.....	272	WB-WS-12-020.....	144	W-WKRP-VE-60.....	185
UZ-TH096128-06.....	272	WB-WS-12-030.....	144	W-WOBU60-BP-60.....	183
UZ-TH160192-01.....	272	WB-WS-12-031.....	144	W-WOBU60-GX-60.....	183
UZ-TH160192-02.....	272	WB-WS-12-032.....	144	W-WOBU60-VE-60.....	183
UZ-TH160192-05.....	272	WB-WS-12-033.....	144	W-WOBU70-BP-60.....	183
UZ-TH160192-06.....	272	WB-WS-12-060.....	144	W-WOBU70-GX-60.....	183
UZ-TH288320-01.....	272	WB-WS-18-001.....	145	W-WOBU70-VE-60.....	183
UZ-TH288320-02.....	272	WB-WS-18-010.....	145	W-WOBU80-BP-60.....	183
UZ-TH288320-05.....	272	WB-WS-18-020.....	145	W-WOBU80-GX-60.....	183
UZ-TH288320-06.....	272	WB-WS-18-030.....	145	W-WOBU80-VE-60.....	183
UZ-TIVOL-192-01.....	253	WB-WS-18-031.....	145	W-WOBU90-BP-60.....	183
UZ-TIVOL-192-12.....	253	WB-WS-18-032.....	145	W-WOBU90-GX-60.....	183
UZ-TIVOL-192-13.....	253	WB-WS-18-033.....	145	W-WOBU90-VE-60.....	183
UZ-TIVOL-320-01.....	253	WB-WS-18-060.....	145	WW-PASEK0-05.....	199
UZ-TIVOL-320-12.....	253	WB-WS-24-001.....	145	WW-SE0102-01.....	199
UZ-TIVOL-320-13.....	253	WB-WS-24-010.....	145	W-WSPD60-BP-60.....	184
UZ-VARES-96-01.....	259	WB-WS-24-020.....	145	W-WSPD60-GX-60.....	184
UZ-VARES-96-02.....	259	WB-WS-24-030.....	145	W-WSPD60-VE-60.....	184
UZ-VARES-96-05.....	259	WB-WS-24-031.....	145	W-WSPD70-BP-60.....	184
UZ-VARES-96-06.....	259	WB-WS-24-032.....	145	W-WSPD70-GX-60.....	184
UZ-VARES-128-01.....	259	WB-WS-24-033.....	145	W-WSPD70-VE-60.....	184
UZ-VARES-128-02.....	259	WB-WS-24-060.....	145	W-WSPD80-BP-60.....	184
UZ-VARES-128-05.....	259	W-CUSTOMI-60L450.....	228	W-WSPD80-GX-60.....	184
UZ-VARES-128-06.....	259	W-CUSTOMI-60L500.....	228	W-WSPD80-VE-60.....	184
UZ-VARES-192-01.....	259	W-CUSTOMI-80L450.....	229	W-WSPD90-BP-60.....	184
UZ-VARES-192-02.....	259	W-CUSTOMI-80L500.....	229	W-WSPD90-GX-60.....	184
UZ-VARES-192-05.....	259	W-INSERTI-L450.....	230	W-WSPD90-VE-60.....	184
UZ-VARES-192-06.....	259	W-INSERTI-L500.....	230	WW-SPDNO-05.....	197
UZ-VASTO-96-09.....	302	WK-CF0750-01.....	156	WW-WSD250-01.....	201
UZ-VASTO-128-09.....	302	WK-CF6450-01.....	156	WW-WSD300-01.....	201
UZ-VER160-01.....	250	WK-D0310-001.....	155	WW-WSD350-01.....	201
UZ-VER160-08.....	250	WK-D0313-001.....	155	WW-WSD400-01.....	201
UZ-VETA-128-01.....	245	WK-D0316-001.....	155	WW-WSD450-01.....	201
UZ-VETA-128-05.....	245	WK-D0320-001.....	155	WW-WSD500-01.....	201
UZ-VETA-128-12.....	245	WK-D0325-001.....	155	WW-WSL250-01.....	200
UZ-VETA-160-01.....	245	WK-D0330-001.....	155	WW-WSL250-01B.....	200
UZ-VETA-160-05.....	245	WK-D0416-001.....	155	WW-WSL300-01.....	200
UZ-VETA-160-12.....	245	WK-D0420-001.....	155	WW-WSL300-01B.....	200
UZ-VETA-320-01.....	245	WK-D0425-001.....	155	WW-WSL350-01.....	200
UZ-VETA-320-05.....	245	WK-D0430-001.....	155	WW-WSL350-01B.....	200
UZ-VETA-320-12.....	245	WK-D0435-001.....	155	WW-WSL400-01.....	200
UZ-VINCE-96-04.....	306	WK-D0440-001.....	155	WW-WSL400-01B.....	200
UZ-WERON-96-04.....	304	WK-D0460-001.....	155	WW-WSL450-01.....	200
UZ-WERON-96-09.....	304	WK-D3516-001.....	155	WW-WSL450-01B.....	200
UZ-WERON-96-12.....	304	WK-D3520-001.....	155	WW-WSL500-01.....	200
UZ-WERON-128-04.....	304	WK-D3525-001.....	155	WW-WSL500-01B.....	200
UZ-WERON-128-09.....	304	WK-D3530-001.....	155	WW-WSL000-01.....	194
UZ-WERON-128-12.....	304	WS-QUAD-14-06.....	330	WW-WSP000-01.....	194
UZ-WP1146-04.....	314	WS-ROND-14-06.....	331	WW-WSP060-05.....	190
UZ-Z10096-01.....	283	WS-SOLO-14-06.....	330	WW-WSP060-PW.....	190
UZ-Z10096-02.....	283	WW-2KOSZ0-05.....	187	WW-WSP070-05.....	190
UZ-Z10096-03.....	283	WW-K0AJ03-01.....	196	WW-WSP070-PW.....	190
UZ-Z10096-05.....	283	WW-K0AJ04-01.....	198	WW-WSP080-05.....	190
UZ-Z10128-01.....	283	WW-K00J03-01.....	197	WW-WSP080-PW.....	190
UZ-Z10128-02.....	283	WW-KJ0101-01.....	195	WW-WSP090-05.....	190
UZ-Z10128-03.....	283	WW-KJ0201-01.....	196	WW-WSP090-PW.....	190
UZ-Z10128-05.....	283	W-WK060-BP-60.....	186	WW-WSPP00-01.....	194
W-AKC-HERBI-L450.....	231	W-WK060-GX-60.....	186	WW-WUBR00-01.....	198
W-AKC-HERBI-L500.....	231	W-WK060-VE-60.....	186	WW-ZWBUT2-10.....	202
W-AKC-HOLDI-L450.....	232	W-WK070-BP-60.....	186	WW-ZWBUT2-20.....	202
W-AKC-HOLDI-L500.....	232	W-WK070-GX-60.....	186	WZ-00-K24-04.....	342
W-AKC-KNIFI-L450.....	231	W-WK070-VE-60.....	186	WZ-804-20-01.....	331
W-AKC-KNIFI-L500.....	231	W-WK080-BP-60.....	186	WZ-804-20-05.....	331
WA-MALAG-A0-01.....	338	W-WK080-GX-60.....	186	WZ-804-20-06.....	331
WA-MALAG-A0-02.....	338	W-WK080-VE-60.....	186	WZ-A0-K23-01.....	335
WA-MALAG-A0-05.....	338	W-WK090-BP-60.....	186	WZ-A0-K23-02.....	335
WA-MALAG-A0-20.....	338	W-WK090-GX-60.....	186	WZ-A0-K23-03.....	335
WA-MALAG-B0-01.....	339	W-WK090-VE-60.....	186	WZ-A0-K23-04.....	335
WA-MALAG-B0-02.....	339	WW-KOSZ60-05.....	189	WZ-A0-K23-05.....	335
WA-MALAG-B0-05.....	339	WW-KOSZ60-PW.....	189	WZ-A0-K23-20.....	335
WA-MALAG-B0-20.....	339	WW-KOSZ70-05.....	189	WZ-A0-K24-01.....	337
WB-073024-01.....	143	WW-KOSZ70-PW.....	189	WZ-A0-K24-02.....	337
WB-073024-06.....	143	WW-KOSZ80-05.....	189	WZ-A0-K24-03.....	337
WB-073025-01.....	143	WW-KOSZ80-PW.....	189	WZ-A0-K24-04.....	337

WZ-A0-K24-05.....	337
WZ-A0-K24-20.....	337
WZ-B0-K23-01.....	335
WZ-B0-K23-02.....	335
WZ-B0-K23-03.....	335
WZ-B0-K23-04.....	335
WZ-B0-K23-05.....	335
WZ-B0-K23-20.....	335
WZ-B0-K24-01.....	337
WZ-B0-K24-02.....	337
WZ-B0-K24-03.....	337
WZ-B0-K24-04.....	337
WZ-B0-K24-05.....	337
WZ-B0-K24-20.....	337
WZ-C0-K24-01.....	338
WZ-C0-K24-02.....	338
WZ-C0-K24-03.....	338
WZ-C0-K24-04.....	338
WZ-C0-K24-05.....	338
WZ-C0-K24-20.....	338
WZ-D-892-02.....	340
WZ-D-892-05.....	340
WZ-E-018-01.....	340
WZ-E-018-02.....	340
WZ-E-018-05.....	340
WZ-E-018-06.....	340
WZ-K23-D1-01.....	336
WZ-K23-D1-02.....	336
WZ-K23-D1-03.....	336
WZ-K23-D1-05.....	336
WZ-K23-D1-06.....	336
WZ-K23-E1-01.....	336
WZ-K23-E1-02.....	336
WZ-K23-E1-03.....	336
WZ-K23-E1-05.....	336
WZ-K23-E1-06.....	336
WZ-K2201-01.....	334
WZ-K2201-06.....	334
WZ-K2201-CS.....	334
WZ-K2201-CZ.....	334
WZ-K2201-NB.....	334
WZ-K2201-PM.....	334
WZ-K2201-RZ.....	334
WZ-K2201-ZL.....	334
WZ-K2202-01.....	334
WZ-K2202-06.....	334
WZ-K2202-CS.....	334
WZ-K2202-CZ.....	334
WZ-K2202-NB.....	334
WZ-K2202-PM.....	334
WZ-K2202-RZ.....	334
WZ-K2202-ZL.....	334
WZ-MALAG-C0-01.....	339
WZ-MALAG-C0-02.....	339
WZ-MALAG-C0-05.....	339
WZ-MALAG-C0-20.....	339
WZ-ORVIE-A0-09.....	341
WZ-ORVIE-B0-09.....	341
WZ-SCTYLPR-BWK.....	150
WZ-SCTYLPR-WK.....	150
WZ-TOLED-A0-01.....	332
WZ-TOLED-A0-02.....	332
WZ-TOLED-A0-05.....	332
WZ-TOLED-A0-06.....	332
WZ-TOLED-B0-01.....	332
WZ-TOLED-B0-02.....	332
WZ-TOLED-B0-05.....	332
WZ-TOLED-B0-06.....	332
WZ-TOLED-C0-01.....	333
WZ-TOLED-C0-02.....	333
WZ-TOLED-C0-05.....	333
WZ-TOLED-C0-06.....	333
ZC-GTV-12-00.....	39
ZC-GTV-14-00.....	39
ZK-FORCE-KPL.....	150
ZK-R1-KPL-10.....	151
ZK-R1-KPL-30.....	151
ZK-STRONG-L1.....	152
ZK-STRONG-P1.....	152

ZK-ZAS-L0-10.....	152
ZK-ZAS-L0-15.....	152
ZK-ZAS-L0-31.....	152
ZK-ZAS-L0-32.....	152
ZK-ZAS-P0-10.....	152
ZK-ZAS-P0-15.....	152
ZK-ZAS-P0-31.....	152
ZK-ZAS-P0-32.....	152
ZK-ZAW-R0-10.....	151
ZK-ZAW-R0-30.....	151
ZK-ZAW-R0-32.....	151
ZM-CHC07ZE.....	30
ZM-CHC08ZE.....	29
ZM-CHC09ZE.....	29
ZM-CNHC07BR2.....	14
ZM-CNHC08BR2.....	14
ZM-CNHC09BR2.....	13
ZM-ECHC07-3DBEO.....	13
ZM-ECHC07BEO.....	10
ZM-ECHC07ZEO.....	10
ZM-ECHC08-3DBEO.....	12
ZM-ECHC08BEO.....	9
ZM-ECHC08ZEO.....	9
ZM-ECHC09-3DBEO.....	12
ZM-ECHC09BEO.....	9
ZM-ECHC09ZEO.....	9
ZM-HCKT30-BE.....	16
ZM-HCKT30-ZE.....	16
ZM-HCKT45-3DBEO.....	17
ZM-HCKT45-BE.....	17
ZM-HCKT45-ZE.....	17
ZM-HCKT90-3DBEO.....	18
ZM-HCKT90-BE.....	18
ZM-HCKT90-ZE.....	18
ZM-HCKT155BE.....	19
ZM-HCKT155ZE.....	19
ZM-HCKT165-3DBEO.....	20
ZM-HCKT165BE.....	19
ZM-HCKT165ZE.....	19
ZM-HCRALU9BE.....	35
ZM-HCREG07-ZEO.....	11
ZM-HCREG08-ZEO.....	11
ZM-HCREG09-ZEO.....	10
ZM-INHC070BEO.....	16
ZM-INHC070ZEO.....	16
ZM-INHC080BEO.....	15
ZM-INHC080ZEO.....	15
ZM-INHC090BEO.....	15
ZM-INHC090ZEO.....	15
ZP-BICN070BEO.....	23
ZP-BICN070ZEO.....	23
ZP-BICN072BEO.....	23
ZP-BICN072ZEO.....	23
ZP-BICN080BEO.....	22
ZP-BICN080ZEO.....	22
ZP-BICN082BEO.....	22
ZP-BICN082ZEO.....	22
ZP-BICN090BEO.....	22
ZP-BICN090ZEO.....	22
ZP-BICN092BEO.....	22
ZP-BICN092ZEO.....	22
ZP-C190H2-ZE.....	32
ZP-CIB17H0ZE.....	31
ZP-CIB18H0ZE.....	31
ZP-CIB19H0ZE.....	30
ZP-CIG-070ZE.....	33
ZP-CIG-07UZE.....	33
ZP-CIG-090ZE.....	33
ZP-CIG-09UBE.....	33
ZP-CIG-09UZC.....	33
ZP-CIG-09UZE.....	33
ZP-CIG-170ZE.....	33
ZP-CIG-17UZE.....	33
ZP-CIG-190ZE.....	33
ZP-CIG-19UZE.....	33
ZP-CHC070ZE.....	30
ZP-CHC080ZE.....	29
ZP-CHC090ZE.....	29
ZP-COCA450-BE.....	27

ZP-COCA450-ZE.....	27
ZP-COCA7450-BE.....	27
ZP-CONL07-BE.....	21
ZP-CONL07-ZE.....	21
ZP-CONL08-BE.....	21
ZP-CONL08-ZE.....	21
ZP-CONL09-BE.....	20
ZP-CONL09-ZE.....	20
ZP-JUNIOR-00.....	38
ZP-KT30H2-BE.....	23
ZP-KT30H2-ZE.....	23
ZP-KT45H2-BE.....	24
ZP-KT45H2-ZE.....	24
ZP-KT90H2-BE.....	24
ZP-KT90H2-ZE.....	24
ZP-KT135H2-BE.....	26
ZP-KT135H2-ZE.....	26
ZP-KT165H2BE.....	26
ZP-KT165H2ZE.....	26
ZP-KT0270-BE.....	36
ZP-KT7270-BE.....	36
ZP-KTK90H6BE.....	25
ZP-KTK90H6ZE.....	25
ZP-KTKN90H0.....	25
ZP-PO7H045BE.....	28
ZP-POH045BEO.....	28
ZP-POH045ZEO.....	28
ZP-RALUH2-00.....	34
ZP-RALUH2-07.....	35
ZP-RALUH2-08.....	34
ZP-SKR-00-80.....	38
ZT-HF-01-D00.....	37
ZT-HF-01-M00.....	37
ZZ-16-103-01.....	387
ZZ-20-103-01.....	387
ZZ-30-103-01.....	387
ZZ-B0-105-01.....	386
ZZ-BA-SK0-01.....	390
ZZ-C1-288-01.....	391
ZZ-C5-288-01.....	391
ZZ-C6-288-01.....	391
ZZ-C8-288-01.....	391
ZZ-CF-138-01.....	385
ZZ-G0-328-01.....	390
ZZ-KLMASTER.....	385
ZZ-KM-138-01.....	384
ZZ-M0-201-01.....	389
ZZ-SZ-407-01.....	387
ZZ-SZ-408-01.....	388
ZZ-SZ-409-01.....	388
ZZ-Z0-202-01.....	389
ZZ-ZN-138-01.....	384
ZZ-ZN-338-01.....	386

Niniejszy katalog produktów został przygotowany przez GTV Poland. Poprzez ciągłe udoskonalanie swojej oferty, zgodnie z wymogami rynkowymi i prawnymi, GTV Poland zastrzega sobie prawo do wprowadzania zmian w przedstawionym asortymencie. Prezentowana publikacja nie jest ofertą w rozumieniu Kodeksu Cywilnego. Rzeczywiste produkty mogą odbiegać od poglądowych zdjęć i rysunków zamieszczonych w publikacji. GTV Poland zastrzega sobie prawo do zmian i błędów w druku.

This product catalogue has been prepared by GTV Poland. Constantly improving its products so as to follow market and legal requirements, GTV Poland reserves the right to introduce changes in the presented product range. The present publication does not constitute an offer within the meaning of the Civil Code. The real products can differ from the example photographs and drawings in the publication. GTV Poland reserves the right to make changes and printing errors.

Данный каталог был создан компанией GTV Poland. В соответствии с действующим законодательством и требованиями рынка, компания GTV Poland оставляет за собой право вносить изменения в ассортимент предлагаемого товара. Данная публикация носит информационно-ознакомительный характер и не является коммерческим предложением в понимании права. Компания не несет ответственности за возможные цветовые расхождения, опечатки и неточности.



GTV

ul. Przejazdowa 21
05-800 Pruszków
Poland

 + 48 22 44 47 564

 + 48 22 44 47 527

 + 48 22 44 47 324

 + 48 22 44 47 580

 + 48 22 44 47 569

 + 420 591 160 091

 ООО 140073, РФ, «ГТВ РУС»
Московская область,
Люберецкий район, пос.Томилино,
Микрорайон Птицефабрика, Литер 7А
+ 7 495 640 15 88

 GTV Croatia d.o.o
Kovinska 4a, 10000 Zagreb
Hrvatska
+ 385 1 798 8089

 GTV Czech Distribution s.r.o.
CTPark Ostrava, Na Rovince 879
720 00 Ostrava Hrabová
Česká republika
+420 591 160 091

 GTV España Herrajes E Iluminación, S.L.
Avenida Aragón 30 8
46021 Valencia
España
+34 960 468 666

fax: +48 22 444 75 01
e-mail: info@gtv.com.pl
www.gtv.com.pl

Follow us on:

